

Engine Analyzer Pro

User's Manual

Version 3.9 B

Performance Trends, Inc.

Box 530164 Livonia, MI 48153

248-473-9230 Fax 248-442-7750

Website: www.performancetrends.com

Email: feedback@performancetrends.com

Performance Trends, Inc. PO Box 530164 Livonia, MI 48152
Tech Assistance for Registered Owners (248) 473-9230 Fax: 248-442-7750 Email: feedback@performancetrends.com

Website (tips, correspond with other users, download demos, update schedule, etc.) www.performancetrends.com

Copyright Notice

Copyright (C) 2016 PERFORMANCE TRENDS, INC. All Rights Reserved

These software programs and user's manual are reserved by PERFORMANCE TRENDS, INC. and are intended for the use of the original owner only. Copying or duplicating these products except for the personal use of the original owner is a violation of U. S. Copyright Law and is hereby expressly forbidden.

Portions Copyright (C) Microsoft Corp. 1982-2009 All Rights Reserved

International Business Machines Corp. makes no warranties, either expressed or implied, regarding the enclosed computer package, its merchantability or its fitness for any particular purpose.

IBM PC, XT, and AT are registered trademarks of International Business Machines Corp.

MS-DOS is a registered trademark of Microsoft Corp.

Cam Dr is a trademark of Quadrant Scientific.

Paxton is a trademark of Paxton Products Inc.

Vortech is a trademark of Vortech Engineering Inc.

Competition Cams is a trademark of Competition Cams Inc.

Depac is a trademark of Depac Dyno Systems

B & M is a trademark of B & M Automotive Products

Weiland is a trademark of Weiland Automotive Industries

Crower is a trademark of Crower Cams

Lunati is a trademark of Lunati Cams

Isky is a trademark of Isky Cams

DISCLAIMER OF WARRANTIES:

THE SOFTWARE PROVIDED HEREUNDER IS LICENSED "AS IS" WITHOUT ANY WARRANTIES, EXPRESS OR IMPLIED, INCLUDING BUT NOT LIMITED TO, ANY WARRANTIES FOR MERCHANTABILITY OR FITNESS FOR A PARTICULAR PURPOSE. NO ORAL OR WRITTEN STATEMENTS, REPRESENTATIONS OR OTHER AFFIRMATION OF FACT, INCLUDING BUT NOT LIMITED TO STATEMENTS REGARDING CAPABILITY, CAPACITY, SUITABILITY FOR USE OR PERFORMANCE OF SOFTWARE SHALL BE RELIED UPON BY USER OR BE DEEMED TO BE A WARRANTY OR REPRESENTATION BY PERFORMANCE TRENDS, INC. FOR ANY PURPOSE, OR GIVE RISE TO ANY LIABILITY OF OBLIGATION OF PERFORMANCE TRENDS, INC. WHATSOEVER. USER ACCEPTS ALL RESPONSIBILITY FOR SELECTING THE SOFTWARE TO MEET USER NEEDS OR SPECIFIC PURPOSES. PERFORMANCE TRENDS INC. IS UNDER NO OBLIGATION TO FURNISH USER UPDATES OR ENHANCEMENTS EVEN IF FURNISHED TO OTHER USERS.

Continued on next page.

LIMITATION Of LIABILITY:

If at the time of delivery to the original User only there are any defects in the media on which the Software is provided, User's sole and exclusive remedy shall be the replacement of any media returned to Performance Trends, Inc. within 90 days of the receipt of the Software by User, or at Performance Trends Inc.'s sole option, a refund of the License fees paid to Performance Trends, Inc. by User.

IN NO EVENT SHALL PERFORMANCE TRENDS, INC. OR THIRD PARTIES WHO HAVE RIGHTS IN THE SOFTWARE BE LIABLE TO USER FOR LOSS Of PROFITS, INDIRECT, SPECIAL, INCIDENTAL OR CONSEQUENTIAL DAMAGES EVEN IF PERFORMANCE TRENDS, INC. IS AWARE Of THE POSSIBILITY OF SUCH DAMAGES.

IN THE EVENT ANY REMEDY HEREUNDER FAILS Of ITS ESSENTIAL PURPOSE, OR IN ANY OTHER EVENT, PERFORMANCE TRENDS INC.'S LIABILITY HEREUNDER SHALL NOT EXCEED ANY AMOUNTS PAID BY USER TO PERFORMANCE TRENDS, INC. UNDER THIS AGREEMENT.

Some states do not allow the limitation or exclusion of liability for incidental or consequential damages and some states do not allow the exclusion of implied warranties, so the above limitations or exclusions may not apply to you.

No action, regardless of form, arising out of any claimed breach of this agreement or performance under this agreement may be brought by either party more than one year after the affected party learns of the cause of action.

Refer to diskette envelope for full license agreement.

***** W A R N I N G *****

The Engine Analyzer Pro makes calculations based on equations and data found in various published and heretofore reliable documents. The program is designed for use by skilled professionals experienced with engines and vehicles. The following processes are hazardous, particularly if done by an unskilled or inexperienced user:

- Obtaining data to input to the program
- Interpreting the program's results

Before making measurements of or modifications to any vehicle, engine or driving situation, DO NOT FAIL TO:

- Regard the safety consequences
- Consult with a skilled and cautious professional
- Read the entire user's manual
- Obey all federal, state & local laws
- Respect the rights and safety of others

Table of Contents

Chapter 1 Introduction	1
1.1 Overview of Features	1
1.2 Before You Start	2
1.3 A Word of Caution	3
1.4 Getting Started (Installation)	4
1.5 Example to Get You Going	5
Chapter 2 Definitions	9
2.0 Basic Program Operation	9
2.1 Preferences	11
2.2 Short Block	13
2.3 Cylinder Head(s)	17
2.4 Intake System	25
2.4.1 Fuel Delivery Specs	31
2.5 Exhaust System	35
2.6 Cam/Valve Train	41
2.6.1 Alternate Cam/Valve Train Specs	45
2.6.2 Valve Train Dynamics Specs	47
2.7 Supercharger	
2.7.1 Roots Supercharger	51
2.7.2 Centrifugal Supercharger	55
2.7.3 Turbocharger	58
2.8 Calculate Performance	63
2.8.1 Calculation Conditions	63
2.8.2 Test Results for Calculated Performance	94
2.9 Calculation Menus	97
Chapter 3 Output	125
3.1 Tuning Pressures	126
3.2 Analysis Report	129
3.3 ASCII Data Files	130
3.4 Graphs	131
3.5 Printer Output	145
3.6 Data Library	147
3.7 See Engine	153

Table of Contents, cont

Chapter 4 Examples	155
Example 4.1 Installing a Larger Carburetor And Intake Manifold	157
Example 4.2 Installing Hydraulic and Solid Lifter Camshafts	167
Example 4.3 Supercharging, Turbocharging And Nitrous Oxide	179
Example 4.4 Using Flow Bench Data	187
Example 4.5 Optimizing Tuning	194
Appendix 1: Accuracy and Assumptions	201
Appendix 2: Summary of 4 Cycle, Internal Combustion Engine Theory	208
Appendix 3: Intake and Exhaust Tuning	214
Appendix 4: "Fine Tuning" Torque & HP Curves	219
Appendix 5: Watching Tuning Pressure and Flow	223
Appendix 6: Why So Many Inputs	230
Appendix 7: Copying Files	232
Appendix 8: Cam Calculations	233
Appendix 9: New Features in Version 3.3	235
Appendix 10: New Features in Version 3.5	251
Appendix 11: New Features in Version 3.9	261
Appendix 12: New Features in Version 3.9 B	277
Appendix 13: Features in Enterprise Edition	287
Index	313

Chapter 1 Introduction

1.1 Overview of Features

The Engine Analyzer Pro program by Performance Trends, Inc. is a software system to help professional engine builders, racers and engineers understand and predict many aspects of full power engine performance. The Engine Analyzer Pro has numerous options to allow the user to simulate innovative and unusual engine designs. The Pro's major features are listed below:

Features:

- Calculation of all parameters every 4 degrees of crank rotation, including dynamic valve lift, valve flow area, cylinder pressure, port pressures, net valve flow, heat losses, etc. Some are calculated every .1 degrees.
- Simulation of intake and exhaust pressure waves for more accurate, sophisticated tuning simulations.
- Provision for full valve flow curve input, at up to 8 lift points.
- Provision for entering cam lift files for detailed specification of cam profiles. Possible formats include Cam Dr (tm), Competition Cams (tm), S96, Doctor Dr (tm), and more.
- Two mass model of valve train dynamics, for accurate and detailed simulation of valve train forces, bending and tossing.
- "Cycle plot" feature to allow plotting of instantaneous valve lift, valve flow area, cylinder pressure, port pressures, piston acceleration, piston thrust, and many other parameters. This allows you to understand why a power curve looks as it does.
- "RPM" plots to allow plotting of any "power curve" parameter vs RPM.
- Inputs to simulate engine details like bearing sizes, anti-reversion, ring leakage, rod length, spark curves, fuel octane, etc.
- Component libraries for storing Cm/Valve Train files, Short Block files, etc. Swap in a new cam and heads with only a couple of mouse clicks! There is also a complete Engine Library for saving combinations of components.
- Built in calculation menus to determine user inputs like compression ratio, carb/throttle body flow rating, cam events @ .050" lift, etc.
- Data output files (ASCII) for use in other data base, spreadsheet or graphics software packages.
- Detailed supercharger and turbocharger simulations.

New Features for Windows Version 2.1

- More accurate intake and exhaust tuning simulations.
- New, more detailed specs, especially for describing intake and exhaust runners.
- Analysis report to help you understand the results and give tips to improve performance.
- 'See Engine' screen shows tuning pressures and flows, and piston-to-valve clearance.
- Calculate results for up to 20 RPMs.
- Displays tuning pressures and flows during calculations, if you wish.
- Saves Test Files of calculated results for future analysis or graphical comparisons.
- Greatly expanded graphing features
- Enhanced printouts of reports and graphs.

See Appendices 9, 10, 11, 12, pages 235-286 for features new to v3.3, 3.5, 3.9, 3.9B.
See Appendices 13, pages 287-312 for features in Advanced Enterprise Edition.

Please read Sections 1.2 "Before You Start" and 1.3 "A Word of Caution" before you turn on the computer. Then try running the program following the guidelines in 1.4 "Getting Started" and 1.5 "Example to Get You Going". When you feel a little familiar with the program, take time to read this entire manual. It will show you all the things you can do with this powerful tool.

1.2 Before You Start

What you will need:

- IBM Pentium computer running Windows XP, Vista, Windows 7 through 10 (or 100% compatible).
- Approximately 30 Megabyte of disk space. (More is required for storing large numbers of tests.)

Many terms used by the Engine Analyzer Pro and this user's manual are similar to terms used by other publications, i.e. Inertia, Correction Factor, etc. However, these terms may have different definitions. Therefore, read Chapter 2 to see what these terms mean to the Engine Analyzer Pro.

Occasionally it will be necessary to identify "typos" in the manual, known "bugs" and their "fixes", etc. which were not known at the time of publication. These will be identified in a file called README.DOC in the Engine Analyzer Pro directory or folder. This file can be displayed right in the Engine Analyzer Pro by clicking on Help at the Main Screen, then clicking on Display Readme.doc File. You can also read it using utilities like NotePad or WordPad.

Unlocking Program Options:

The Engine Analyzer Pro is equipped with copy protection. This ensures the legitimate users do not have to cover the costs for unauthorized distribution of the program. When you first receive the program, it is in demo mode. **All features work in Demo mode.** In demo mode you can try either the Basic version, or the full Professional version for ten days. Sometime during those 10 days, you must call Performance Trends to obtain an "Unlocking Code". This Unlocking Code will be for either the Basic version or the Pro Version, whichever you have purchased.

Before you call Performance Trends, you should get your disk serial number (stamped in blue on the disk), your registered name and code number, and computer hardware number. The registered name and code numbers are available by clicking on file in the upper left hand corner of the Main Screen, then clicking on Unlocking Program Options. A screen will appear as shown in Figure 1.1.

Performance Trends will provide you an unlocking code number. Type in the unlocking code number and click on OK. If you typed in the number correctly, you will be given a message that the program is permanently unlocked. The program will only run on this one computer.

If you want to run the program on another computer, you must install it, obtain the computer hardware number and registered code number as shown in Figure 1.1, and call Performance Trends for a new Unlocking Code for that computer. There may be a charge for additional computers.

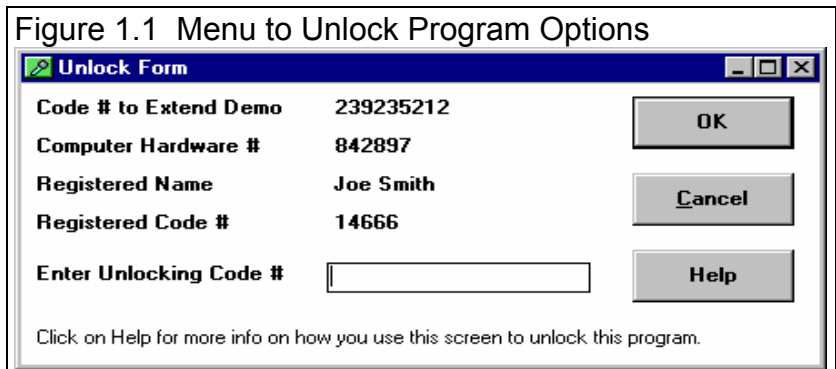

You may need to transfer the program to another computer, like when you buy a new computer. If so, install the program on the new computer. It will run for 10 days. During that 10 days, call when you can have your old computer up and running. Go into the Engine Analyzer Pro program, click on File, then Transfer Program to Another Computer. Performance Trends will ask for some numbers from this screen and give you a code # which will **permanently** turn the program Off on this old computer. Then give Performance Trends the information for the new computer and they will give you a new unlocking code **free**

Also see Section 1.4 on page 4.

1.3 A Word of Caution

The Engine Analyzer Pro is a comprehensive software package which estimates an engine's performance based on limited user input. These estimates can be used for analysis of dynamometer, race track or normal street performance.

An engine is a very complex system, which makes exact calculations of all details impossible. Therefore, several simplifying assumptions are made to reduce the calculations to a manageable level. See the Assumptions in Appendix 1. The user must recognize:

The software can not predict the safety of an engine modification or running situation. Done correctly, with the proper quality parts and safety precautions, extreme engine conditions can be safe. Done by inexperienced builders with standard or low quality parts, an engine can be a "disaster waiting to happen". Please read and follow the "Safety Notes" as highlighted in this manual.

The software, like any computer model, can NOT make exact predictions because:

- Much of the input data to the software is estimated.
- Even if the input data were exactly correct, the simplifying assumptions within the program will limit the accuracy.
- Environmental conditions, temperatures, etc. are rarely constant and repeatable.

The software should be used as a guide to:

- Help you understand how an engine works; what parameters are important, how parameters interact, what are the trade offs, etc.
- Point you in the correct, general direction for making modifications. This direction should be verified by other sources like known authorities, engine tests, books, etc. Never trust one "single source" if it does not make sense to you.
- Make you think, not think for you. If unexpected results are obtained, take a minute to:
 - Double check all your data input.
 - Refer back to this manual.
 - Ask someone else skilled and experienced in the particular area.
 - Give the retailer or Performance Trends Inc's. Tech Help Line a call for an explanation. (Computer programs are written by normal people who can make mistakes. It's always possible there may be an error in the calculations. Your phone call may help us correct it.)

Please also read the Warranty and Warning at the beginning of this manual and on the diskette envelope.

IMPORTANT: The Engine Analyzer Pro program will ask for engine specs and measurements to be entered. The Engine Analyzer Pro program is NOT checking for all safe limits of the engine design. **You** must have your engine design checked by a qualified engineer or engine builder to determine its safe operating range.

1.4 Getting Started (Installation)

You must install the Engine Analyzer Pro from the CD to a hard drive before it will run. To do this, generally you can simply put the CD in the CD drive and close the door. The installation program should start automatically, bringing up the Performance Trends Installation Wizard. This program can install most any of our products in Demo mode, including the Engine Analyzer Pro you just purchased. Select (click on) the button for Engine Analyzer Pro and the installation will begin.

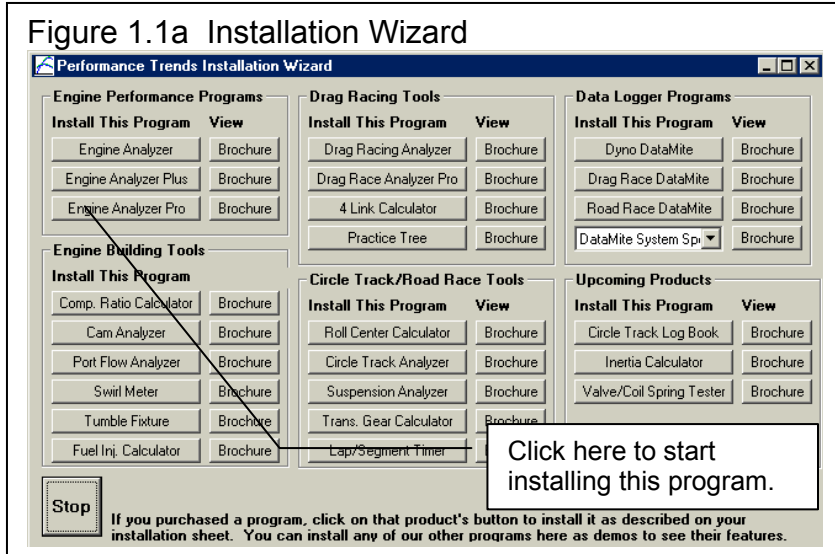

Entering Registered Owner's Name:

The first time you run the Engine Analyzer Pro, you will be asked to enter your name as the Registered Owner. During this first session, you can modify it until you are satisfied. Once you accept the name, the computer will generate a Registered Code # based on the name. To be eligible for Tech Help, you will need both your registered name and code #, and to have sent in your registration card. The name you enter should be very similar to the name you enter on the registration card.

Click on Help, then About Engine Analyzer Pro at the Main Screen to review your name and code # .

Unlocking Program Options:

The Drag Race DataMite Analyzer is equipped with copy protection. **Check Section 1.2 on page 2** for details on unlocking the program via a code # you can obtain from Performance Trends.

Important: In the 10 day Demo mode, all features work as in the working version. Therefore you do not need to immediately unlock it before you use it. Then, even after 10 days, you can still call for an unlock code. Its just that after 10 days, the program will not do anything other than let you unlock it.

1.5 Example to Get You Going

To start the Engine Analyzer Pro, click on the desktop icon for Engine Analyzer Pro. After some brief introduction screens, you will be left at the Main Menu shown below.

From this main menu, you can:

- Choose to review or modify any of the categories of engine specifications displayed.
- Retrieve or save a file of complete engine specifications by clicking on the Retrieve or Save buttons (first 2 buttons on the left) or the File menu item, then either Load or Save.
- Add, edit or review engine comments to describe the engine currently held in the program.
- Calculate engine performance from the options listed under Calculate Performance. From here you can specify calculation options (barometric pressure, humidity, nitrous oxide, fuel type, etc.) and select to do Chain Calculations.
- Change the Preferences options to somewhat customize the program for you.
- Get HELP to explain these options by clicking on Help or pressing <F1>.
- Quit the program by clicking on File, then Exit.

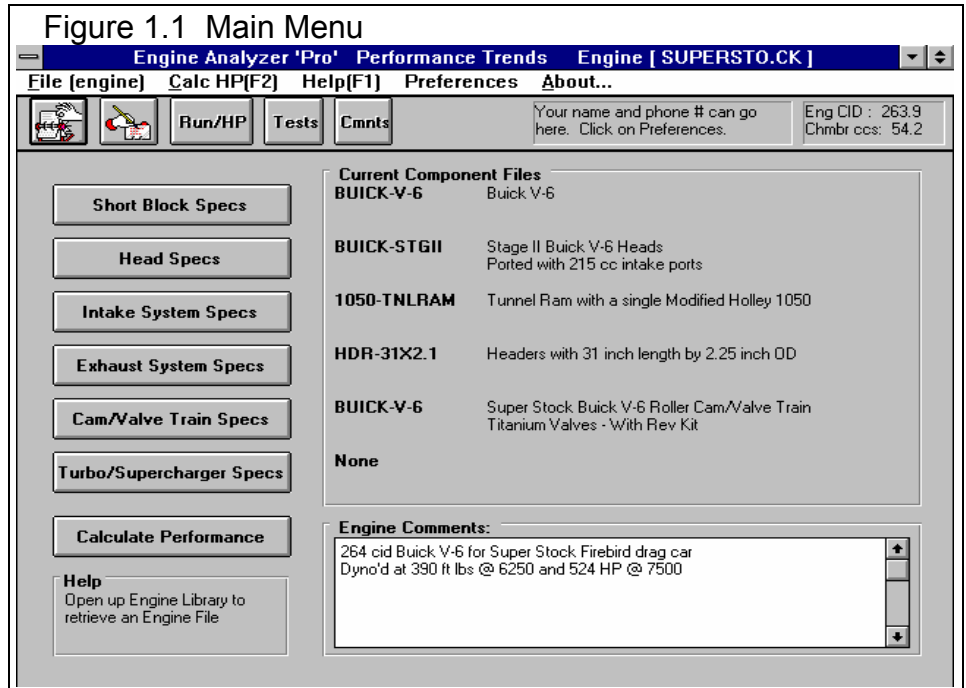

All these options are explained in detail in Chapters 2 and 3.

In the Main Menu's blue title bar you will notice the current Engine is [SUPERSTOCK]. The program has descriptions of engines saved in the Library right from the factory. The current file from the Engine Library is called SUPERSTOCK.

To get started, let's examine (but not change) the various categories of specs. Click on a button for one of the categories like Short Block, Intake System, etc. A new menu will appear displaying the various specs and the current values for the SUPERSTOCK engine. In this menu's blue title bar you will also notice a component file.

The Engine File called SUPERSTOCK is made up of several major components. Each component has its own library of various Short Blocks, Intake Systems, etc. This is explained in Section 3.6 "Data Libraries". You can click on the name of any spec and a brief description appears in the Help frame, along with a page # from this manual for more help. You can return to the Main Menu by clicking on OK or clicking on an area outside the Component menu.

Now click on the Calculate Performance button in the Main Menu to calculate performance for this SUPERSTOCK engine. The next menu will show you the Calculation Conditions menu as shown in Figure 1.2.

For now, leave all the Calculation Conditions as they are and click on the Calculate Performance button. This will start the program calculating performance for the specifications of the SUPERSTOCK stored in the Engine Library with the Calculation

Conditions currently displayed. Results are displayed as each RPM is calculated, and a progress bar graph shows how the calculations are progressing. The calculations may require several minutes on slower computers.

The final results will appear as in Figure 1.3. There are 2 basic sections:

- RPM data with results for each RPM you requested
- Special calculations which are independent of RPM, like Engine Displacement, Dynamic Compression Ratio, etc.

Since all the results can not fit on one screen, you must click on the slide bars on the right side of each section to view all the results. If you have calculated results for more than approximately 12 RPMs, you may also need to use the horizontal slide bar to see data for all RPMs you requested.

Figure 1.2, Calculation Conditions Menu

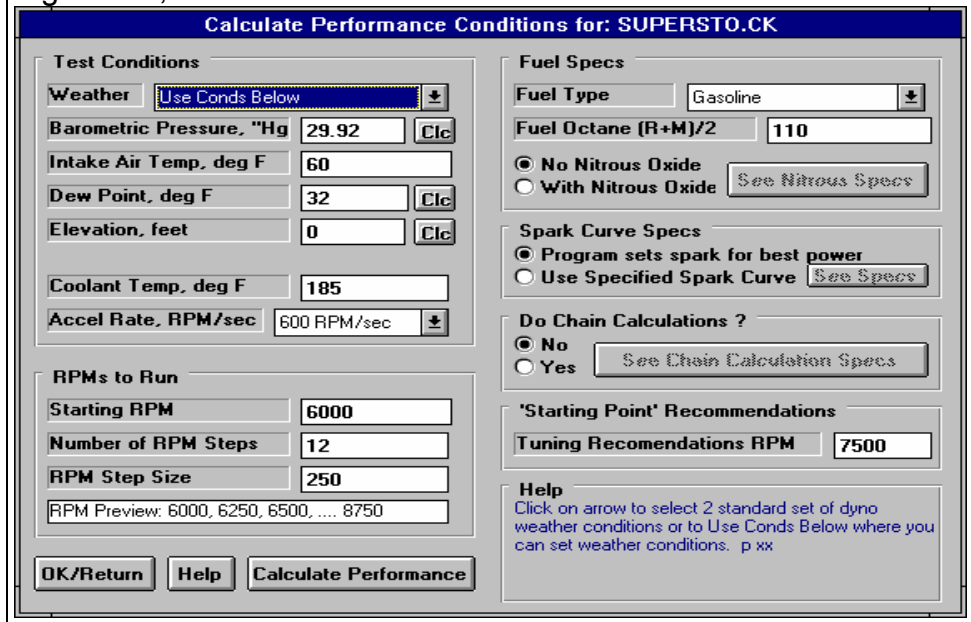

The results contain much information, some which may not be familiar to you. However, the first three rows in the RPM section do look familiar:

- Engine RPM for engine speed in revolutions per minute
- Brk Tq for Brake Torque in ft lbs
- Brake HP for Brake Horsepower

A torque peak of 403 ft lbs at 6250 RPM with a HP peak of 552 at 7750 RPM. Sure is easier than dyno testing! (Results may be different in later versions of the program.)

The menu bar and the command buttons at the top of the screen shows some of the options for various formats for data output:

- Analyze will produce a report of performance and safety tips on the test results
- Graph will produce various types of graphs. You can also compare the current test results to results of other tests you have saved.
- See Engine will show you a cross section view of your

Figure 1.3, First Portion of Calculated Results

Engine Analyzer Pro Engine [SUPERSTO.CK] Test Results [Untitled]												
Back Graph Print Help(F1) File Analyze See-Engine												
Notes Summary: Valve Toss, Piston speed! EXTREMELY! high. PkTq=403@6250 Avg=368 Click on Notes for more Details. PkHP=552@7750 Avg=511												
	6000	6250	6500	6750	7000	7250	7500	7750	8000	8250	8500	8750
Engine RPM	6000	6250	6500	6750	7000	7250	7500	7750	8000	8250	8500	8750
Brk Tq, ft-lbs	400	403	399	394	395	393	384	374	358	322	310	286
Brake HP	457	480	493	506	527	542	549	552	545	506	501	477
Exh Pres, PSI	0.0	0.0	0.0	0.0	0.0	0.0	0.0	0.0	0.0	0.0	0.0	0.0
Int Vac, "Hg	0.4	0.4	0.4	0.5	0.5	0.5	0.6	0.6	0.6	0.6	0.6	0.5
Vol Eff, %	112.6	114.9	113.5	110.9	111.1	112.1	113.8	113.7	111.2	103.2	99.1	94.6
Actual CFM	516	548	563	571	594	620	652	673	679	650	643	632
Fuel Flow, lb/hr	189	200	206	209	217	227	238	246	248	238	235	231
Nitrous, lb/hr	0.0	0.0	0.0	0.0	0.0	0.0	0.0	0.0	0.0	0.0	0.0	0.0
Ntrs Fuel, lb/hr	0.0	0.0	0.0	0.0	0.0	0.0	0.0	0.0	0.0	0.0	0.0	0.0
BMEP, PSI	229	230	228	225	226	225	220	214	205	184	177	164
A/F Mxtr Qlty, %	99.2	99.7	100.0	100.0	100.0	100.0	100.0	100.0	100.0	100.0	100.0	100.0
BSEC, lb/HP-hr	0.402	0.407	0.406	0.401	0.401	0.407	0.422	0.433	0.442	0.455	0.453	0.467

Valve Flow & Cam Calculations				--int--		--Exh--	
Overlap Area, deg*sq-in	48.3	Ulv Area, deg*sq-in	424.3	347.9			
Total Exh/Int %	82.0	Total Avg Flow Coef	0.381	0.502			
Lobe Separation, deg	105.8	Lobe Area, inch*deg	40.17	37.71			
Overlap, deg	121	Duration, deg	329	335			
		Opening Events, deg	62	96			
		Closing Events, deg	88	59			
Overlap @.050, deg	74	Duration @.050, deg	279	292			
		Opn Evnts @.050, deg	37	75			
		Cls Evnts @.050, deg	62	37			
		Duration @.200, deg	199	202			

engine so you can watch intake and exhaust flows and tuning pressures, as well as see piston-to-valve clearance and valve train bending and tossing.

- Print lets you print these test results.

If you have a printer hooked up to your computer, try the Print command by clicking on Print in the menu bar or on the Printer button. A small menu of printout options are presented. These options allow you to enter a report comment, include engine specs and comments in the printout, etc. These options are explained in Section 3.5. For this first time, accept the default settings and print the report by clicking on Print Results.

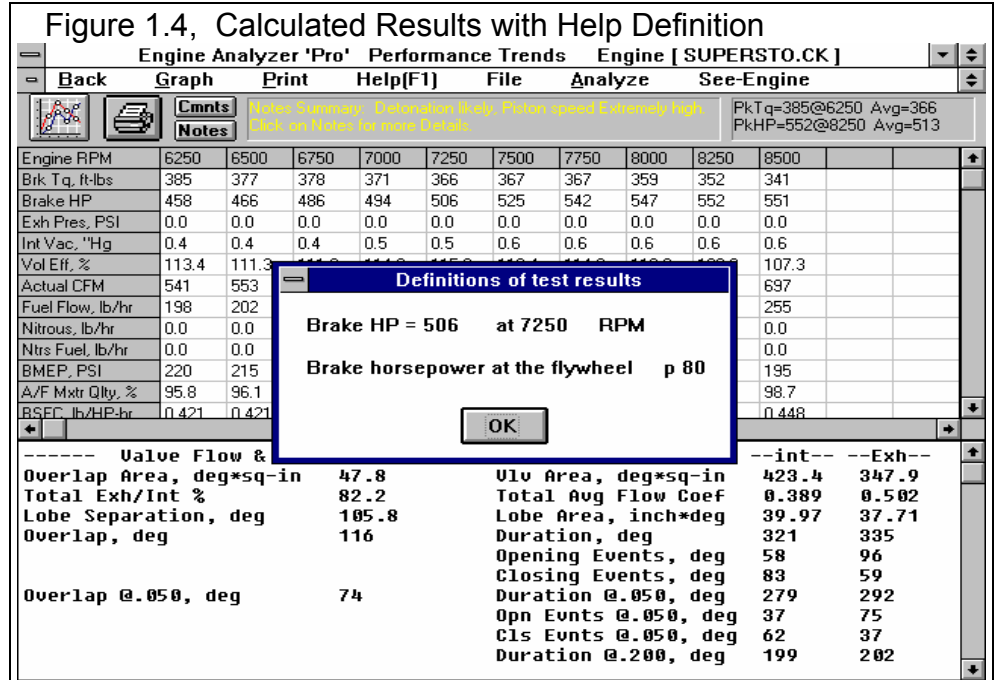

To help explain the other rows of output in the RPM or Special Calculations section, simply click on the results. A definition of that particular test result will be presented in a Message box as in Figure 1.4. Then click on OK when you have read the definition.

For a detailed explanation of all the results, Calculation Conditions, and output options, go to Section 2.8 and Chapter 3. Clicking on Back or pressing the <ESC> key will return you to the Main Menu. From the Main Menu you can modify the SUPERSTOCK to see the effect on performance. For example you could go into any of the component menus and:

- Specify a "wilder" cam (more duration or lift)
- Install better heads (higher compression ratio, higher flow coefficients and/or larger valves)
- Install a supercharger or turbocharger

The beauty of the program is you can try things which are too expensive, too risky, or simply not possible with current technology.

Many of the input specifications you see in the various menus may not be familiar to you. For a brief definition of the inputs, simply click on the specification name. The definition will appear in the Help frame with a page # in this manual for more info.

Some of the engine specifications have "Clc" buttons. One example is Compression Ratio in the Head(s) menu. "Clc" stands for "calculate". For example, if you want to calculate compression ratio from chamber volume, deck height, etc., simply click on the Clc button. The program will display a new menu listing the inputs and the Calc Compression Ratio from these inputs. For further explanation, click on the Help buttons in these menus. To use the Calc Compression Ratio calculated from these inputs, click on the Use Calc Value button. Otherwise click on Cancel to return to the Head(s) menu with no change to Compression Ratio. Section 2.9, Calculation Menus explains all these calculations.

Once you feel comfortable changing specifications in the various menus and making various performance calculations, read Section 3.6 of this manual called Data Libraries to learn how to save a set of total engine or component specifications or recall information which has been previously saved. Then you will know all the basic commands to operate the program. For a more in-depth knowledge of using these commands and an explanation of the results, read this entire manual.

Chapter 2 Definitions

2.0 Basic Program Operation:

Figure 2.1 shows the Engine Analyzer Pro's Main Menu with explanations of your options here. Figure 2.2 shows the Cam & Valve Train menu with explanations of options for most component menus.

Figure 2.1 Basic Main Menu Features

Menu bar where you can select: 1) File and then to save or retrieve an Engine file or to exit the program, 2) Calc HP to calculate results like torque and HP, 3) Help to bring up help screens to explain your options, 4) Preferences menu where you can custom tailor the program to your needs, 5) About screen to display your user name and code #, and the version # of the program

Command buttons where you can select: 1) To retrieve an Engine file from the Engine Library, 2) Save the current specs to the Engine Library, 3) Run the program (calculate torque, HP, etc.), 4) Review results from previous Tests (calculated torque, HP, etc. results), 5) Display the engine comments along with the comments for all the component specs

Buttons to display component specs menus

Program title which appears on printouts. This is a good place for a business name. Click on Preferences to change it.

Name of current complete engine file

Current cubic inch displacement and total chamber volume in CCs based on Short Block and Head specs

Comments for the current component files which make up this complete engine file

Names of current component files which make up this complete engine file

Enter comments to describe the engine here

Click here to display Calculation Conditions (RPMs to run, weather conditions, etc.)

Move mouse over an area of the menu and a description of the item is shown here

The screenshot shows the main menu of the Engine Analyzer Pro software. At the top is a menu bar with 'File (engine)', 'Calc HP(F2)', 'Help(F1)', 'Preferences', and 'About...'. Below the menu bar is a toolbar with icons for file operations and a 'Run/HP' button. The main window is divided into several sections: a left sidebar with buttons for 'Short Block Specs', 'Head Specs', 'Intake System Specs', 'Exhaust System Specs', 'Cam/Valve Train Specs', and 'Turbo/Supercharger Specs'; a central 'Current Component Files' list showing 'BUICK-V-6', 'BUICK-STGII', '1050-TNLRAM', 'HDR-31X2.1', and 'BUICK-V-6' with their respective descriptions; and a bottom section for 'Engine Comments' with a text area and a 'Calculate Performance' button. A 'Help' button is also present in the bottom left.

Figure 2.2, Explanation of Sections of Typical Menu

Names of component specs. Click on them for a description in the Help frame.

Option buttons. Click on one or the other to select a program option. Many times this will enable or disable (dim) other program specs or buttons.

Drop down combo box. If there's a white space between the down arrow button and the text entry box, that means you can either type something in the box, or click on the arrow button to select a pre-programmed selection.

Drop down combo box. If there is NO white space between the down arrow button and the text entry box, that means you can only click on the arrow button to select a pre-programmed selection.

Standard text entry box where you can type in a component spec.

Name of component file displayed in this menu.

Calculation button which usually opens up another menu where you can calculate the spec from other inputs.

“Non standard” Command button which opens up another menu or screen which is unique to this particular component menu.

Comment text frame to enter a comment to describe these component specs. These comments are saved with the specs in the Component Library.

Standard Command button to save the current set of specs to the Component Library under a name of your choice.

Standard Command button to open up the Component Library for this particular component menu. Here you can retrieve a new set of specs for this component menu. These could be specs saved at the factory or specs you have saved.

Standard Command button to bring up Help for this component menu

Standard Command button to close this component menu

2.1 Preferences

Click on the Preferences item in the menu bar at the top of the Main Menu screen to bring up the Preferences menu shown in Figure 2.3. Here you can adjust some program items to personalize the program for your needs.

As you can see there is some empty space in this menu. It will likely grow with new options as we get feedback from users.

Program Title Comments

Enter most any text here for the First and Second lines. These 2 lines will appear at the top of printouts and printed graphs. This is a good place for your business name or your personal name. You can change these entries as often as you wish.

Jet Recommendations

Click on this combo box to select if you want the carburetor jet recommendations in the test results given either as:

- Holley Jet #
- Jet Diameter in thousandths of an inch.

Lifter Pump Up Shows HP Loss

Click on this combo box to select if you want the program to either:

- When estimated hydraulic lifter pump up has occurred, to *ask* you if the program should assume lifter pump up has occurred. You can then answer Yes or No. If you answer No, you will then see how the program would estimate performance if lifter pump up did not occur at this RPM. However at each higher RPM the program will again ask you the same question. If this can become tedious, you may want to select the second option of *Always* described below.
- When estimated hydraulic lifter pump up has occurred, *Always* will go ahead and simulate the power loss to be expected when lifter pump up has occurred.

Preferences have been greatly expanded in later versions. See Appendices 9 – 13 on pages 235-312 for more updated info.

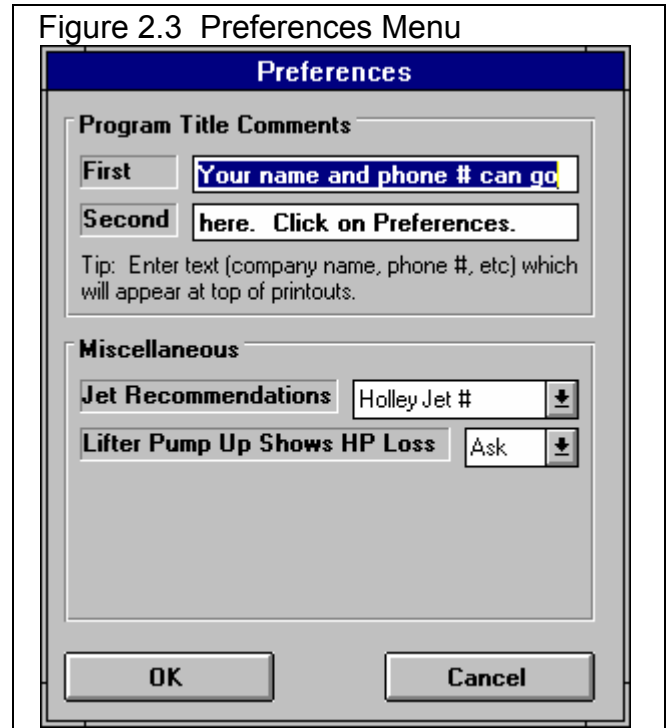

2.2 Short Block

The Short Block specs describe the engine's size, pistons, rings, bearings and front end accessories. It also displays important engine volumes calculated from the current Short Block menu and Compression Ratio from the Cylinder Head(s) menu. By changing Bore, Stroke and # Cylinders, you can immediately see the effect on cylinder displacement, total engine displacement, and clearance volume (assuming Compression Ratio stays fixed).

Bore, inches

The diameter of the cylinder measured in inches.

Stroke, inches

The distance the piston travels from TDC (top dead center) to BDC (bottom dead center) measured in inches.

Of Cylinders

The number of cylinders for the engine. For example, for a V-8 this number is 8, for a single cylinder engine this number would be 1.

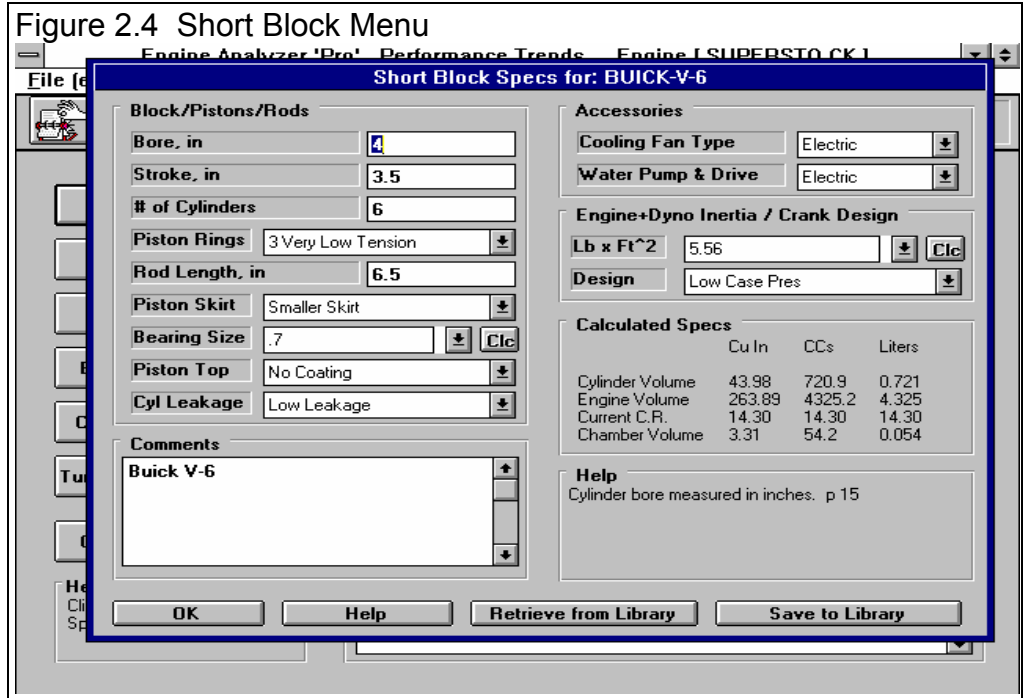

Figure 2.4 Short Block Menu

Piston Rings

Click on this combo box to pick a general description of the # and tension of the piston rings. This specification only affects engine friction and not cylinder sealing.

Rod Length, in

The distance from the center of the wrist pin bore to the center of the crank journal bore measured in inches. This distance is typically not critical. If you do not know it, multiply the stroke by 1.7.

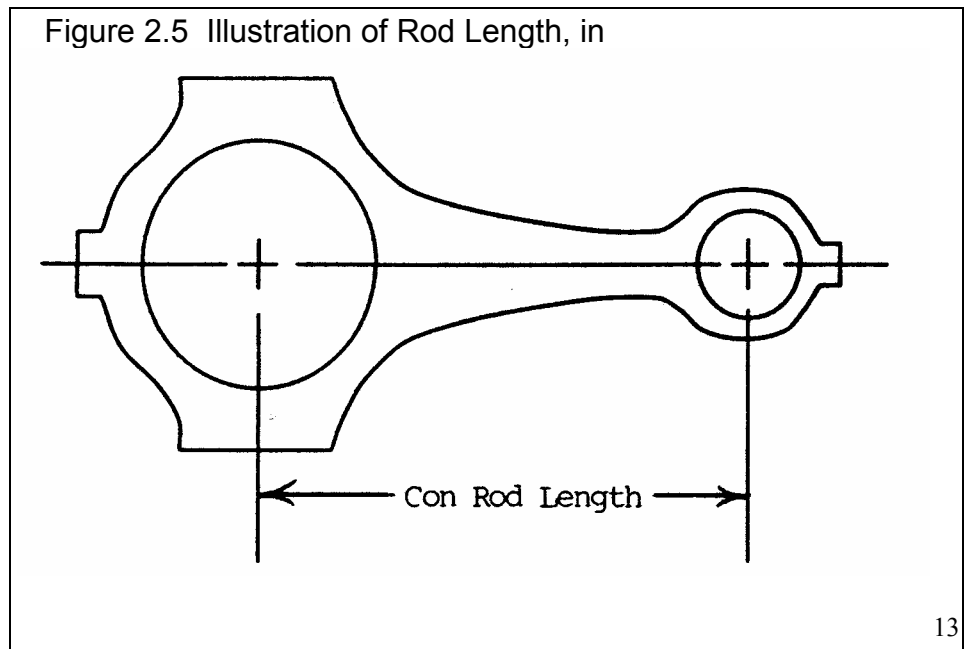

Figure 2.5 Illustration of Rod Length, in

Piston Skirt

This combo box describes the size of the piston skirt that rubs on the cylinder bore. This specification only affects engine friction.

For users who want more detail, use Table 2.1 to pick an appropriate Piston Skirt description based on the piston's effective piston skirt length. Effective piston skirt length describes the average length of the skirt which rubs the bore, which is below the lowest piston ring, usually the oil control ring. See Figure 2.6. Table 2.1 shows the effective piston skirt length for the various ratings for different bores.

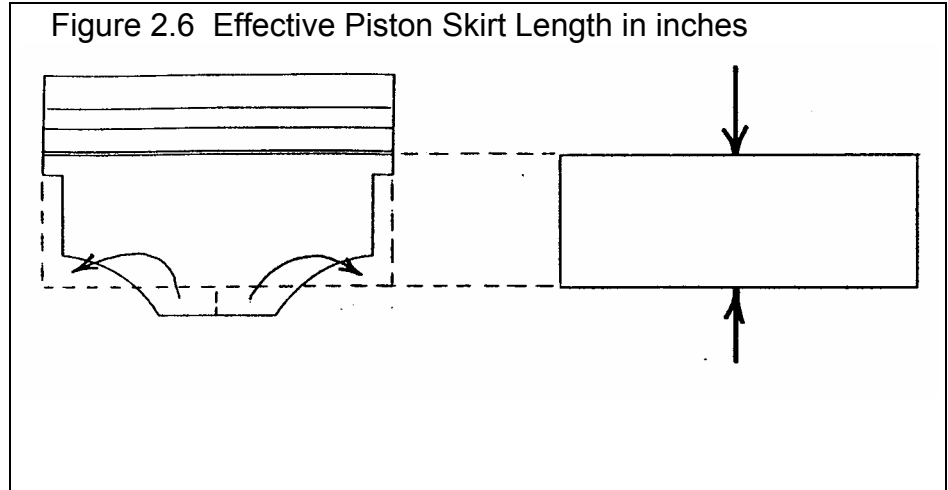

Table 2.1 Effective Piston Skirt Length in Inches for Piston Skirt Ratings

Bore, inches	Typical Skirt	Small Skirt	Very Small Skirt	Large Diesel Skirt
3"	1.36	.95	.54	1.77
4"	1.81	1.27	.73	2.36
5"	2.27	1.59	.91	2.95

Bearing Size

This combo box lets you either:

- Enter a number for Bearing Size Coefficient (a number you are probably not familiar with).
- Click on the arrow button to pick a general Bearing Size Coefficient from a list.
- Click on the Clc button and calculate the actual Bearing Size Coefficient from engine bearing sizes.

Bearing Size Coefficient describes the relative size and number of the connecting rod, main and cam bearing journals for an engine with this bore size. If you calculate the bearing size coefficient by clicking on the Clc button, see the details as explained in Section 2.9.1. The bearing size coef should be between .3 and 2.0 and only affects engine friction, not durability effects.

Safety Note: *Specifying small bearings with the computer to reduce engine friction and produce better power is significantly easier than having small bearings "live" in an actual engine. The Pro does NOT check to ensure bearing sizes are adequate for any particular running loads.*

Piston Top

This combo box lets you pick if the top of the piston has been treated with any "heat insulating coatings". Properties of insulating coatings can vary and may not match the properties assumed by the Pro. For most cases, an insulating coating will improve thermal efficiency (BSFC and fuel economy) and hurt performance (volumetric efficiency will drop). Also see Material/Coating under Head Specs in Section 2.3.

Cylinder Leakage

This combo box describes the relative cylinder leakage by the piston rings. The Pro only considers lost power due to lost gasses pushing on the piston. It does not consider and friction or durability problems with blow-by destroying the oil film on the cylinder bore.

Cooling Fan Type

This combo box describes the type of cooling fan used to draw air through the radiator. This specification only affects engine friction. The Engine Analyzer Pro assumes the fan size and friction level is related to engine size. Therefore, if you change engine displacement, the program automatically changes the fan size to accommodate for the additional cooling requirements.

Table 2.2 Description of Cooling Fan Types

Type of Fan	Description
None	No cooling fan on engine.
Electric	Electric fan which uses battery power. No direct connection to crankshaft so no direct loss.
Clutch	Production, automotive with viscous clutch . (These fans are identified by LIGHTLY trying to spin the fan when the engine is not running, key out of the ignition. If the fan spins with light force, it has a viscous clutch. SAFETY NOTE: BE CAREFUL NOT TO TURN OVER THE ENGINE, AS INADVERTENT ENGINE STARTING RESULTING IN HAND INJURIES IS POSSIBLE.)
Flex	Production, automotive with "flex" blades. (These fans have blades made of thin, spring steel or plastic which are easily bent back by hand and by air as engine speed increases.)
Solid Steel	Production, automotive fan with fixed blades. (These fans have blades made of thick steel, where the blades maintain the same "pitch" or "angle cutting the air" at all engine speeds. These fans are common on the cars of the 60s or older.)

Water Pump & Drive

Describes the type of water pump and belt/pulley system which drives it. Use Table 2.3 to determine the correct type of water pump and drive. This specification only affects engine friction.

Table 2.3 Description of Water Pumps

Type of Water Pump	Description
None	No water pump (usually engine has no cooling system or is air cooled)
Electric	Pump is driven by electric motor from battery power
Lower Belt Ratio	Pump has larger pulley or crank has smaller pulley to underdrive the pump
Small Pump	Pump has smaller diameter impeller or fewer vanes on pump, or other efficiency improvements.
Production Size	Typical production pump

Note: The Engine Analyzer Pro assumes the size and friction level of the water pump and drive is related to engine size. Therefore, if you change engine displacement, the Engine Analyzer Pro automatically changes the size of the water pump and drive to accommodate for the additional cooling requirements.

Inertia, Lb x Ft²

This combo box lets you:

- Type in an inertia value (which may be difficult for you to estimate)
- Pick it from a list by clicking on the arrow button
- Calculate it from other inputs by clicking on the Clc button.

Inertia in Lb/Ft² is the rotating inertia of the engine, flywheel and dynamometer in units of pounds x feet squared. Although inertia does not affect power at a steady RPM, it does absorb power while the engine is accelerating. (This power is not lost, but can be recovered when the engine decelerates. For example, when the car "jumps" ahead when being "power shifted", the "jump" is from recovering the power absorbed in the engine's inertia.)

Some dynamometer tests are done under accelerating conditions. The Engine Analyzer Pro can simulate steady state or accelerating dyno tests by setting Accel Rate, RPM/Sec in the Calculation Conditions menu. If Accel Rate is set to 0 (steady state) this spec is ignored because no power is lost to inertia. The higher the Accel Rate and the higher the Total Inertia, the more power lost to inertia. See Section 2.9.2 for calculating Total Inertia.

Crankshaft Design

This combo box lets you pick a general design of the crankshaft as far as windage drag is concerned. Windage can rob significant amounts of power from the engine, especially at high speed. Pick from the following designs.

- High Oil Drag is where there is higher than normal drag, like oil overfill or excessive foaming where the crank actually hits the oil level.
- Typical windage would be a typical production design without provisions to minimize windage (like scrapers, windage tray, deep sump, etc.)
- Low windage would be where provisions have been made to minimize windage (like scrapers, windage tray, deep sump, etc.)
- Low Case Pressure is where a small air pump is used to reduce crankcase pressure *significantly* to over 10" mercury vacuum. This is also the best choice for dry sump systems.

2.3 Cylinder Head(s)

The cylinder head specs affect intake and exhaust flow potential, compression ratio and the combustion chamber.

Intake Port Specs:

Valves/Ports

Identifies if there are 1, 2 or 3 intake valves per cylinder and how many ports there are for this number of intake valves. If 2 or 3 valves are specified, both valves are assumed to be equal size and opened exactly the same. If 2 or 3 ports are specified, the program also assumes the intake manifold has the same number of runners. Therefore, if you have 2 or 3 valves per cylinder, and the ports from these valves siamese (run into each other) in the head or right after the head, specify the number of ports as 1. Click on the See Layout button at the bottom of this menu to see what the program assumes your head layout is based on your inputs.

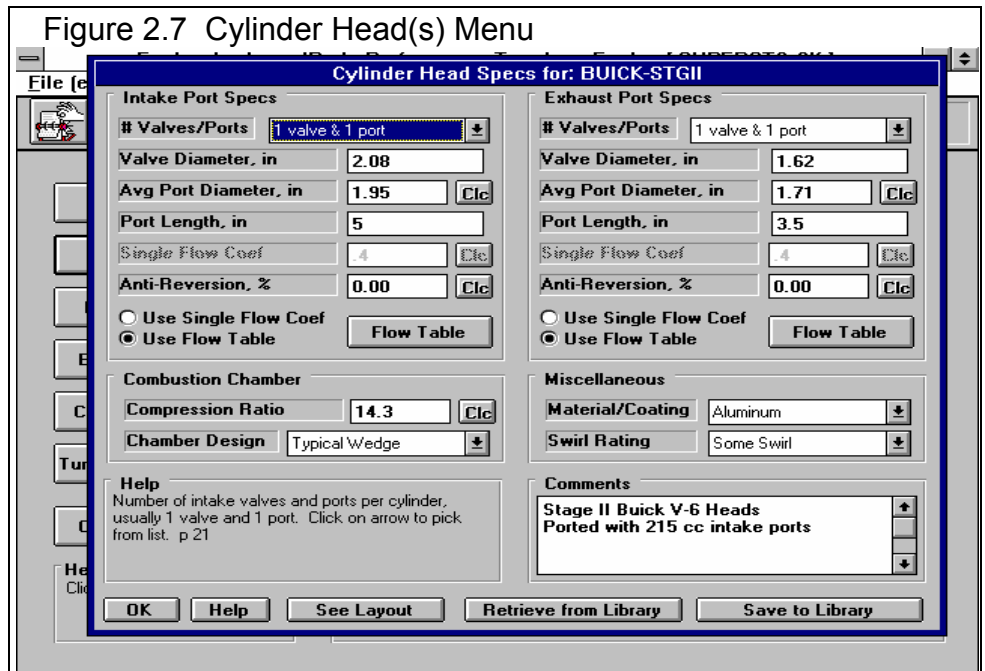

Figure 2.7 Cylinder Head(s) Menu

Valve Diameter, in

Identifies the outside (largest) diameter of the head of the intake valve(s) in inches.

Avg Port Diameter, in

Identifies the average inside diameter of the intake port(s) over their entire length in the cylinder head. Usually this can be measured at the end of the port which mates to the intake manifold. A more precise way is to calculate the diameter by measuring the port volume and port length.

If the ports are oval or rectangular, or you know the port volume in CCs and length, click on the Clc button described in section 2.9.3, to calculate the effective diameter. If you set the number of ports to 2 or 3, this is the diameter of only 1 of these ports. These ports are assumed to be the same length and diameter.

Avg Port Diameter is used by the Pro to determine critical flow velocities, which significantly effect both intake and exhaust tuning and therefore performance. Try to be reasonable accurate inputting this value.

Port Length, in

Is the length of the intake port (down the center of the port) from the intake valve to the end of the head port (the start of the intake manifold runner). For many common heads, 4.5"-6" is a typical length. This spec, combined with the Intake Manifold Runner Length, has a significant impact on intake tuning and therefore performance. Try to be reasonably accurate inputting this value.

Cylinder Head Flow:

- Single Flow Coef
- Flow Table

The flow capacity of the heads can be described by a combination of the valve area (diameter) and an engineering term called flow coefficient. The total flow capacity of the intake port and valve has a substantial impact on performance. Precise information for a particular head design is only available from flow tests on a flow bench. A flow bench is a device which will maintain a constant pressure drop across the port and measure the amount of air flow the pressure drop produces. CFM (Cubic Feet per Minute) flow measurements are usually made with the valve at various lifts. From this data and knowing the valve diameter, flow coefficients can be calculated.

Flow coefficient is a way of defining how well a port flows for the size of flow area. Flow coefficients can vary from .20 for a very restrictive port and valve up to 1.0 for a "free breathing" port design at low valve lifts.

As lift increases, the valve opening area (curtain area) increases, flow increases and the flow coefficient changes somewhat. See Figures 2.8 and 2.9. This continues until valve lift is approximately equal to 1/4 the valve's diameter. This lift is also called an L/D (ratio of valve lift to valve diameter) of .25. At this point the valve area stops increasing with lift. The minimum flow area is now the valve throat, not the "curtain area" around the circumference of the valve. See Fig 2.9. Additional valve lift gives no increase in valve area, although flow may still increase.

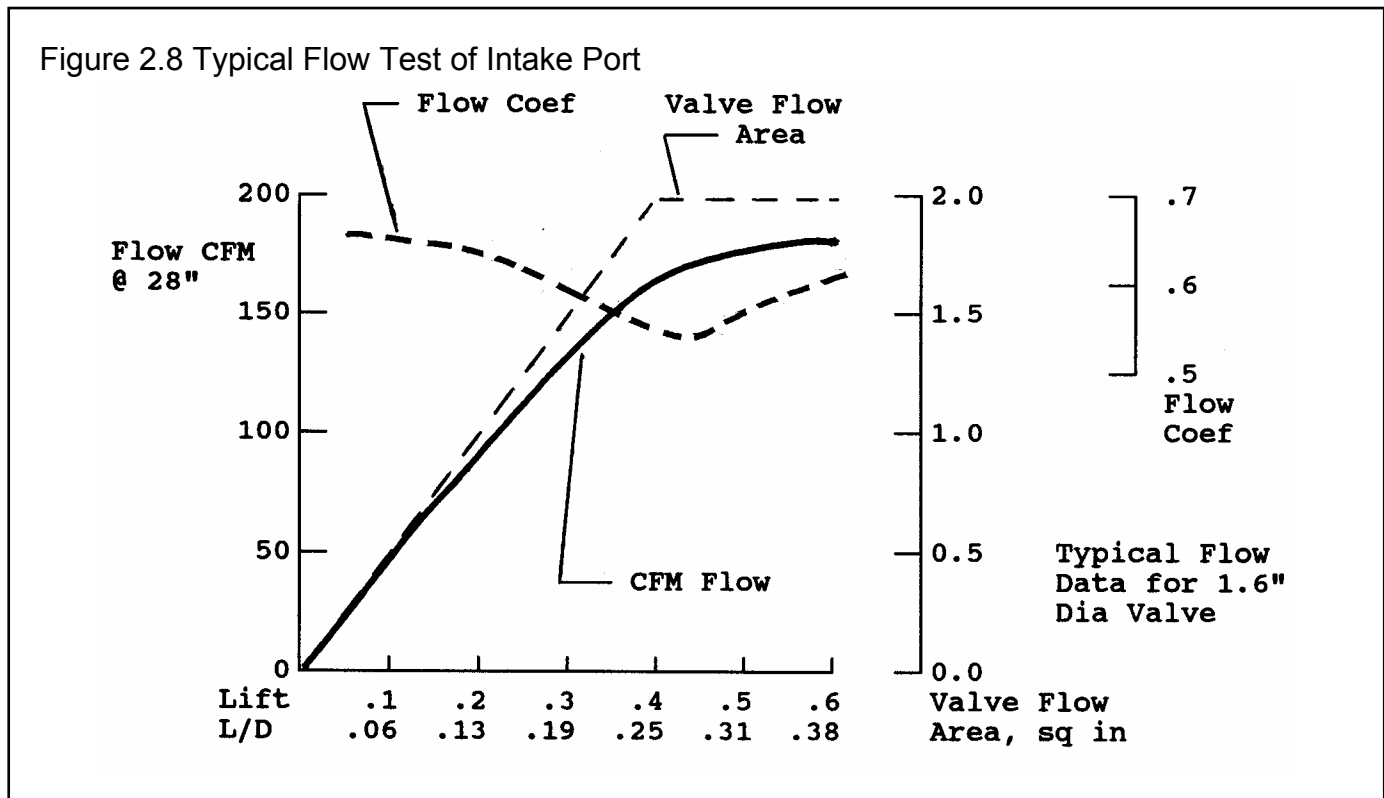

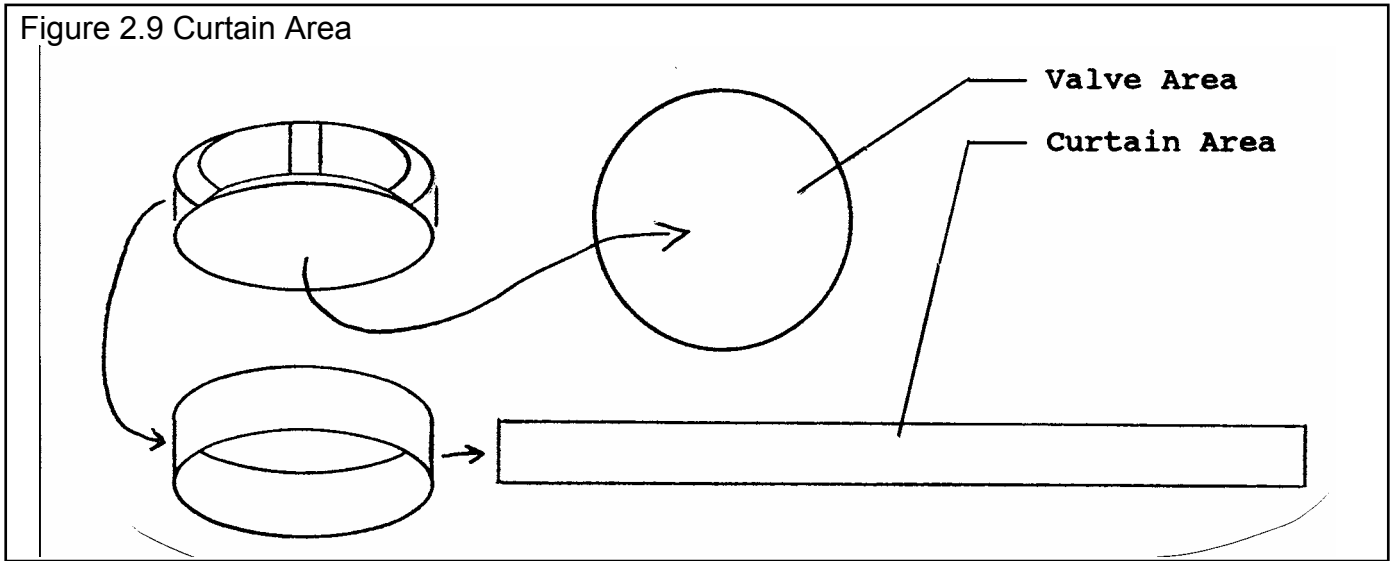

The Engine Analyzer Pro lets you describe the flow characteristics of the port by either:

- Entering one flow coefficient at the lift giving L/D=.25 if:

Use Single Flow Coef option button is marked. This enables the Single Flow Coef spec and disables the Flow Table button.

- Entering flow values to calculate flow coefficients for a series of lifts, similar to data obtained in flow bench testing if:

Use Flow Table option button is marked. This disables the Single Flow Coef spec and enables the Flow Table button.

Single Flow Coef

If you do not have a full flow curve, the Engine Analyzer Pro can estimate the full curve from a flow coefficient at L/D=.25. Table 2.4 gives some examples of flow coefficients for specific heads.

Description & Source	Int		Exh	
	FC	Dia	FC	Dia
Stock "461" SB Chevy, Hot Rod 3/88	.439	2.02	.410	1.60
Stock "993" SB Chevy Open Chmbr, Vizard *	.449	1.94	.389	1.60
Stock "186" SB Chevy Clsd Chmbr, Vizard *	.423	1.94	.466	1.50
Light Portd Bow Tie SB, Hot Rod 3/88	.476	2.05	.527	1.60
Bow Tie SB, CNC Portd 24502482, Cir Trk 9/93	.605	2.15	.722	1.62
Dart II SB Chev, C.I., Hot Rod 3/88	.538	2.02	.546	1.60
AFR SB Chev, Alum, Ported, Engines 93	.556	2.02	.520	1.60
Brodix SB Chev Track 1 Alum, Portd, Vizard *	.495	2.02	.550	1.60

Description & Source	Int		Exh	
	FC	Dia	FC	Dia
Buick-Dart SB Chev Alum, Portd, Vizard *	.522	2.22	.667	1.63
Lt Pt BB Chev, C.I. Oval Port, Perf Trnds	.495	2.19	.400	1.88
Portd BB Chev, C.I. Rect Port, SS&DI 6/81	.50	2.30	.46	1.90
Lt Pt BB Chev Merlin C.I. Oval Port, PrfTrns	.479	2.19	.445	1.88
Portd Dart Alum 360 BB Chev, Sonny's Racing	.574	2.30	.561	1.90
Ported 2.0L Ford OHC 4 cyl, Perf Trends	.490	1.75	.450	1.50
Stock AR SB Ford Alum, Super Ford 8/89	.464	1.94	.439	1.60
Portd AR SB Ford Alum, Super Ford 8/89	.541	1.94	.614	1.60
Stock TFS SB Ford Alum, Super Ford 8/89	.498	1.94	.400	1.60
Portd TFS SB Ford Alum, Super Ford 8/89	.561	1.94	.637	1.60
Stock 1970 351W SB Ford, C.I., SprFrd 8/89	.442	1.84	.397	1.54
Portd 1970 351W SB Ford, C.I., SprFrd 8/89	.541	1.84	.565	1.54
Stock 1987 302 SB Ford, C.I., Car Crft 5/87	.412	1.78	.443	1.45
Portd 70 Boss 302 Trans Am, Perf Trends	.510	2.19	.440	1.71
Portd "Pro Stock" Cleveland, SS&DI 6/81	.520	2.25	.460	1.71
Briggs & Stratton, 5 HP, Perf Trends	.245	1.12	.294	.99
Pont RamAir III Stock, HP Pont 4/91 (adj) **	.409	2.11	.395	1.77
Pont RamAir IV Stock #641, HP Pont 4/91 (adj) **	.510	2.11	.466	1.77
Pont 15° 10033867 Portd, Chevy HP 6/93	.525	2.13	.640	1.61
Stock Mopar 360A, P4529589, Hot Rod 11/91	.418	2.02	.482	1.60
Portd Mopar 360A, P4529589, Hot Rod 11/91	.490	2.02	.516	1.60
Stock Mopar 440B, 452, Perf Trends	.429	2.08	.413	1.74
Light Portd Mopar 440B, 452, Perf Trends	.465	2.14	.517	1.74
Stock Mopar 440B, 240618, Perf Trends	.537	2.08	.471	1.88
426 Hemi Stock, SAE 660342	.539	2.25	-	-
426 Hemi Ported, SS&DI 6/81	.60	2.25	.56	1.94
1600 cc VW Stock Dual Port, Novak & Ass.	.482	1.40	.385	1.26
1600 cc VW Stock Dual Port 041, Novak & Ass.	.428	1.54	.464	1.26
1600 cc VW (aftermarket) AC910, Novak & Ass.	.455	1.97	.507	1.50

* How to Build & Modify Chevrolet Small Block V-8 cylinder Heads, David Vizard, Motorbooks International, 1991.

** Adjusted down to match other sources of stock Pontiac flow data

Additional heads are loaded in the cylinder Head(s) Library with full flow curves. If you have flow bench data at approximately L/D=.25, click on the Clc button to calculate Single Flow Coef as described in Section 2.9.4.

Note:

The total flow potential of a port depends not only on the flow coefficient, but also on the number of valves per cylinder and the valve diameter. A very good Single Flow Coefficient (at L/D=.25) of say .6 to .75 does not mean the port/valve is not restrictive and limiting power. What it means is to flow more air, you probably must increase the valve size. See Figure 2.10.

Figure 2.10 Illustration of Valve Size (Diameter), Single Flow Coef, and Effect of Flow Bench Air Flow and Engine HP Potential

Large Valve, 2" Dia
Large COEF, .6
Flow = 280 CFM
HP = 600

Large Valve, 2" Dia
Small COEF, .3
Flow = 140 CFM
HP = 380

Small Valve, 1" Dia
Large COEF, .6
Flow = 70 CFM
HP = 270

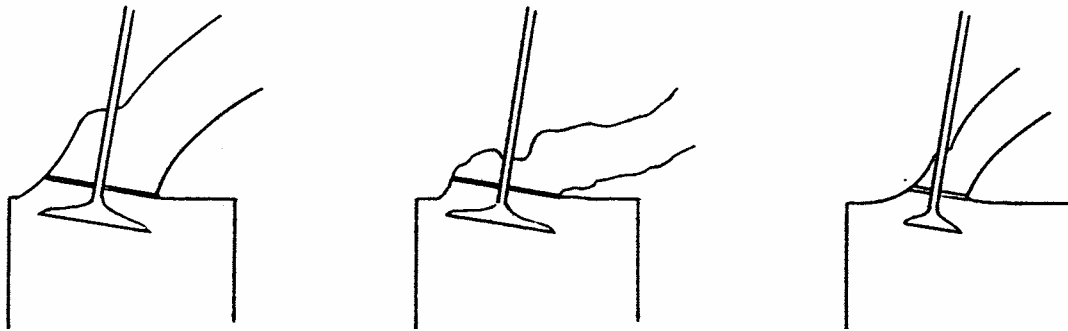

Flow Table

If you have checked the Use Flow Table option button:

- Use Single Flow Coef
- Use Flow Table

The Flow Table button becomes enabled. Click on it to bring up the Intake Flow Table screen as shown in Figure 2.11.

Enter the valve lift (or valve L/D) and the flow obtained during the flow test for up to 8 different valve lifts. You will notice that as you enter lift in inches, L/D is automatically calculated and filled in, and vice versa. As L/D is entered, lift in inches is calculated. The L/D is based on the current intake Valve Diameter in the Head(s) Specs menu.

Figure 2.11 Flow Table To Completely Describe Port Flow Characteristics

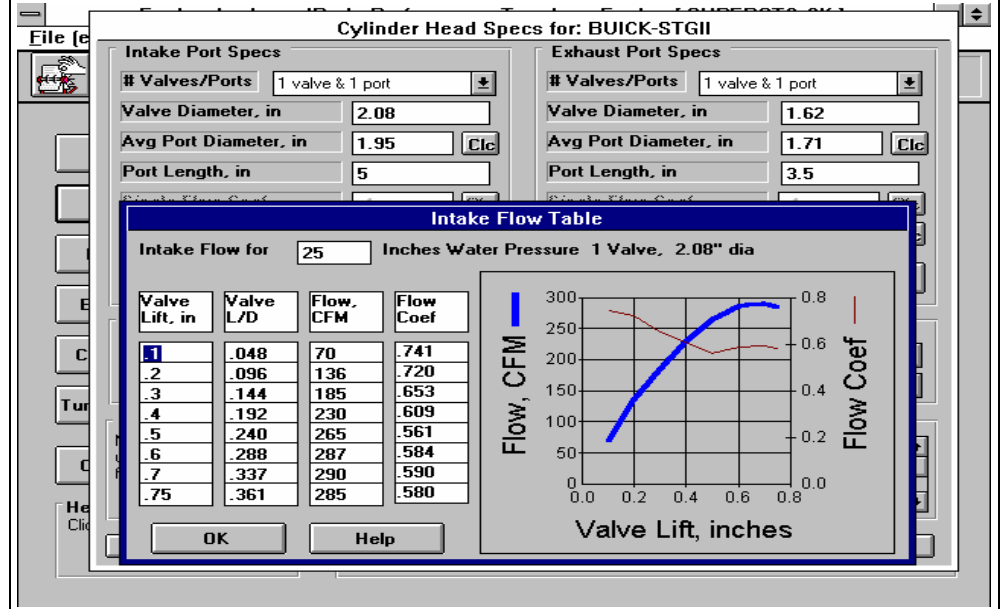

You must also specify the test pressure used during the flow test, or to which the flow data is corrected. Specify test pressure with the text box at the top of the screen. Common test pressures include 10, 25 and 28 inches of water.

When both a lift and CFM flow rate are available, a flow coefficient for that lift is calculated and reported in the Flow Coef column and graphed. The CFM flow is also graphed at the appropriate lift. The flow coefficient is useful to check if your flow data is "reasonably accurate". For example, the flow coefficient will likely be lowest at L/D=.25. See Figure 2.8. The flow coefficient will generally be its highest at low valve lifts because the flow restriction is due mostly to the valve and not the port itself. Flow coefficients greater than 1.0 are highly unlikely except at very low lifts. Flow coefficients less than .3 are highly unlikely for OHV ports, less than .2 are unlikely for flat head ports. See Example 4.4, "For Advanced Users".

If you are obtaining unreasonable flow coefficients, check to ensure you have specified the correct test pressure, # Valves/Ports and Valve Diameter.

Notes:

If you are going to use the flow table, it is best to have at least 4 flow points, 2 points at less than $L/D=.25$, 1 point at approximately $L/D=.25$ and 1 point at maximum valve lift. If you have less than these points, it may be best to select the Use Single Coef option button.

For accurate flow tests, use radiused inlets (not the bare head) for flowing intake ports. Exhaust flow tests should be conducted with short (6-12 inches), straight exhaust pipes bolted to the port (not the bare head). See Runner Flow Coef under Intake System, Section 2.9.7 and Example 4.4.

Flow Table features have been expanded in later versions. See Appendices 9 - 13 on pages 235-312 for more updated info.

Anti-Reversion, %

Describes how well the port, valve and manifold resist flow in the reverse direction. For the intake this would be flow leaving the cylinder and "back flowing" into the intake. Ports which flow equally well in both directions would have 0% anti-reversion. A port with reed valves (check valves) which only allow flow into the cylinder would have 100% anti-reversion. See Section 2.9.5 and Example 4.4 for calculating anti-reversion from flow test data. Note: Most heads have very little or 0 anti-reversion.

Combustion Chamber:

Compression Ratio

The engine's compression ratio based on cylinder clearance volume and total cylinder swept volume (sometimes called *static* compression ratio). Do not use compression ratios which are corrected for cam timing, weather or supercharger boost.

$$\text{Compression Ratio} = \frac{\text{Clearance Volume} + \text{Swept Volume}}{\text{Clearance Volume}}$$

Clearance Volume and Swept Volume must be in the same units, both either CCs or cubic inches. Multiply CCs by .061 to obtain cubic inches, multiply cubic inches by 16.39 to obtain CCs.

Since Compression Ratio has a Clc button, see Section 2.9.6 for calculating Compression Ratio from clearance volume, piston dome volume, deck height and gasket thickness.

Chamber Design

This combo box lets you pick a general chamber design. This spec affects:

- How well the chamber burns the air/fuel mixture for various compression ratios.
- Spark plug location and number of spark plugs which affects burn rate.
- V3.9 B now added Direct Injection to this list of descriptions.

Table 2.5 Descriptions of Chamber Designs

Type	Description
Typical Wedge	Wedge chamber with spark plug significantly offset from the center, high compression requires significant piston popup, squish/quench area does NOT have extremely tight clearance and is a low percent of the total chamber
Compact Wedge	Wedge chamber with spark plug more centrally located, high compression does not require significant piston popup, squish/quench area does have extremely tight clearance (.040-.060" depending on RPM range) and is a high percent of the total chamber, valve angles generally have to be reduced for this type of chamber.
Hemi	Hemispherical chamber with centrally located spark plug, large domed pistons, squish/quench area does NOT have extremely tight clearance (.040-.060", depending on RPM range) and is not a high percent of the total chamber.
Flat Head	Large chamber with valves and spark plug off to the side of the bore.
Pent Roof	Similar to hemi, but for most typical 4 valve engines.
Dual Plug option for all designs listed above	Select the dual plug version of one of the chamber designs above if it has 2 spark plugs which fire at approximately the same time but at different locations in the chamber

This spec does NOT affect flow as that is described by the flow coefficient data described earlier.

Miscellaneous:

Material/Coating

This combo box lets you pick the head material (cast iron or aluminum) and whether any heat insulating coating is applied to the inside of the combustion chamber in the head. See Piston Top under Short Block specs, Section 2.2.

Swirl Rating (name switched to Burn Rating in v3.3)

This combo box lets you pick a general description of the motion of the air/fuel charge in the combustion chamber after the intake valve closes. Some intake ports and/or valves are designed to spin or swirl the charge, thus setting up a little "hurricane" in the combustion chamber. This swirl causes the charge to burn faster, resulting in higher pressures and higher power output. However, an intake port which is designed to swirl the charge can be restrictive. Great care must be taken to develop ports which produce good swirl and are free flowing. Use Table 2.6 for picking a Swirl Rating.

Tumble is another type of mixture motion, usually more evident in 4 valve engines. Engines with good tumble should specify a higher swirl rating. Swirl rating can also be used to speed up or slow down the burn rate the program is assuming for your engine. If the program is calculating that your engine requires more spark advance than it actually needs (the Spark Curve option *Program sets spark for best power* must be selected), increase the swirl rating here to reduce the required spark advance.

Table 2.6 Swirl Ratings

Swirl Type	Description
No Swirl	Standard head where swirl has been given no consideration in the design
Some Swirl	Production heads identified as "High Swirl" or "Fast Burn" which require less spark advance than most heads.
Good Swirl	Heads with considerable flow bench and dyno development time to produce good swirl (not necessarily the highest swirl). These are heads which require much less spark advance than typical heads.

Exhaust Ports:

Valves/Ports
Valve Diameter, in
Avg Port Diameter, in
Port Length, in
Single Flow Coef
Flow Table
Anti-Reversion

For these specs, see the definitions under Intake Ports in this section.

Note: Generally, exhaust ports have higher flow coefficients than intake ports by approximately .05. Exhaust flow tests should be conducted with short, straight exhaust pipes (not the bare head). See Section 2.9.4 and Example 4.4. Ameduri Racing Products of Norco, CA, 909-371-8672 sells "Flow Tubes" for this purpose. They are designed to work on flow benches where space is tight.

2.4 Intake System

The intake system specs affect intake tuning, restrictions, manifold heating, fuel metering and fuel mixture quality.

Note: Intake System Specs have been greatly expanded in later versions. See Appendices 9 - 13 on pages 235-312 for more updated info.

Manifold Specs (x rnr/cyl)

The "x rnr/cyl" depends on the current value of # Valves/Ports under Intake Port specs in the Head(s) menu. If x=2 or x=3, then the Manifold Specs of Runner Dia @ Head, Runner Length, Runner Flow Coef and Runner Taper describe only 1 of the 2 or 3 intake manifold runners for each cylinder.

Runner Dia @ Head, in

Identifies the effective inside diameter of the intake manifold runner(s) where the manifold attaches to the head. If the runners are oval or rectangular or you know the runner volume and length, click on the Clc button as described in section 2.9.3, to calculate the effective diameter.

The program assumes the same number of intake manifold runners per cylinder as you specify # Valves/Ports in the cylinder Head(s) menu. The Runner Dia @ Head is the diameter of only 1 of the runners. All runners are assumed to be the same length and diameter.

Runner Length, in

Is the length of the intake runner from the cylinder head port to the first "abrupt enlargement" of the runner upstream of the cylinder head. The "abrupt enlargement" can be several different things:

- The intake manifold plenum. The plenum is the open area where all the runners merge, directly under the carburetor(s) or after the throttle body on fuel injected manifolds. The best example of a plenum is the very evident "box" on "tunnel ram" type manifolds. See Figure 2.16.
- The end which is open to atmosphere (or air cleaner) on individual runner fuel injection or carburetion. For "individual runner" carb systems, the runner length actually extends through the carb and through any velocity stack or air horn.
- Any point where a runner from one cylinder merges with a runner from another cylinder.

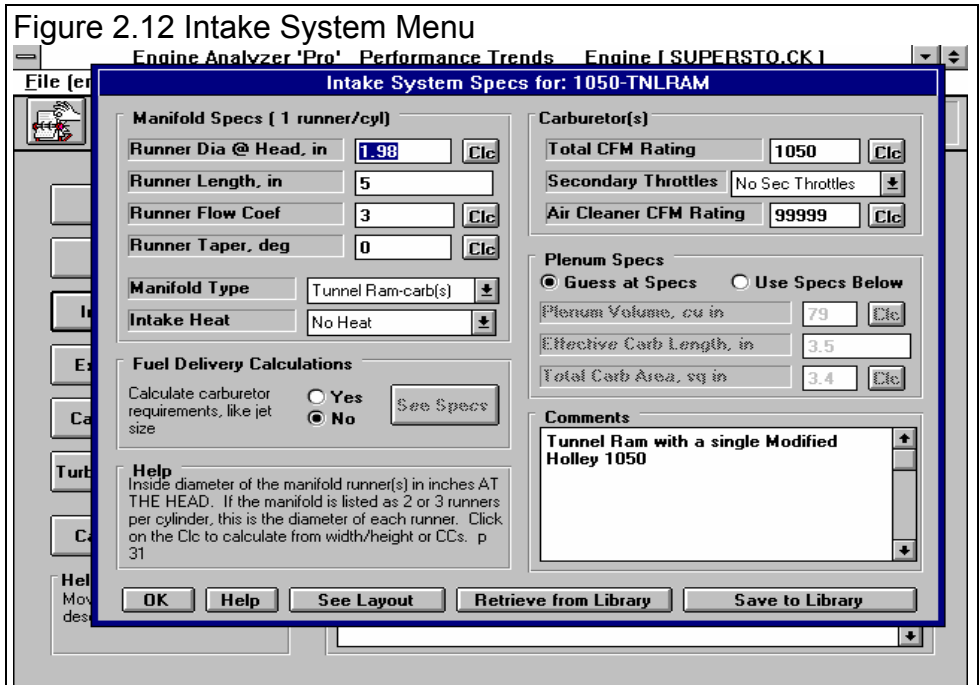

Figure 2.12 Intake System Menu

Most production, carbureted manifolds have runners from 3 to 12 inches in length. Manifolds for modern, production fuel injected engines generally have longer runners (8-20 inches) to take advantage of intake tuning effects at mid-range RPMs. Most manifolds have runners which vary in length from cylinder to cylinder. Use the average length of all the runners, or the average of the longest and shortest runner for this spec.

Runner Flow Coef

Is similar to the Single Flow Coef number for the valve in the Head(s) menu, but describes the design of the runner within the intake manifold. This does not describe the size or length of the runners, as they have been described by other specifications. This specification says "for its particular size, how well is the intake runner designed". Obviously, sharp bends to clear a distributor or provide for hood clearance, rough irregular surfaces, or abrupt changes in runner size where the intake manifold mates to the head, are undesirable from a restriction and tuning point of view. See Figure 2.13.

A general rule for a good manifold (and port) design is one where you can see the entire intake valve for all cylinders from the carburetor or throttle body. This type of design would likely have a Runner Flow Coef of 3, indicating virtually no restriction due to the manifold design. Use Table 2.7 to estimate the Runner Flow Coef.

Table 2.7 Estimates of Runner Flow Coef

Manifold Description	Estimated Runner Flow Coef
Production, carbureted manifolds	.7 to 1.5
Production manifolds for individual cylinder fuel injection	1.0 to 2.0
Aftermarket, dual plane intake manifolds	1.0 to 2.5
Aftermarket, single plane, "X" type or "tunnel ram" manifolds	2.0 to 3.0
Race single plane (sheet metal, custom design)	3.0

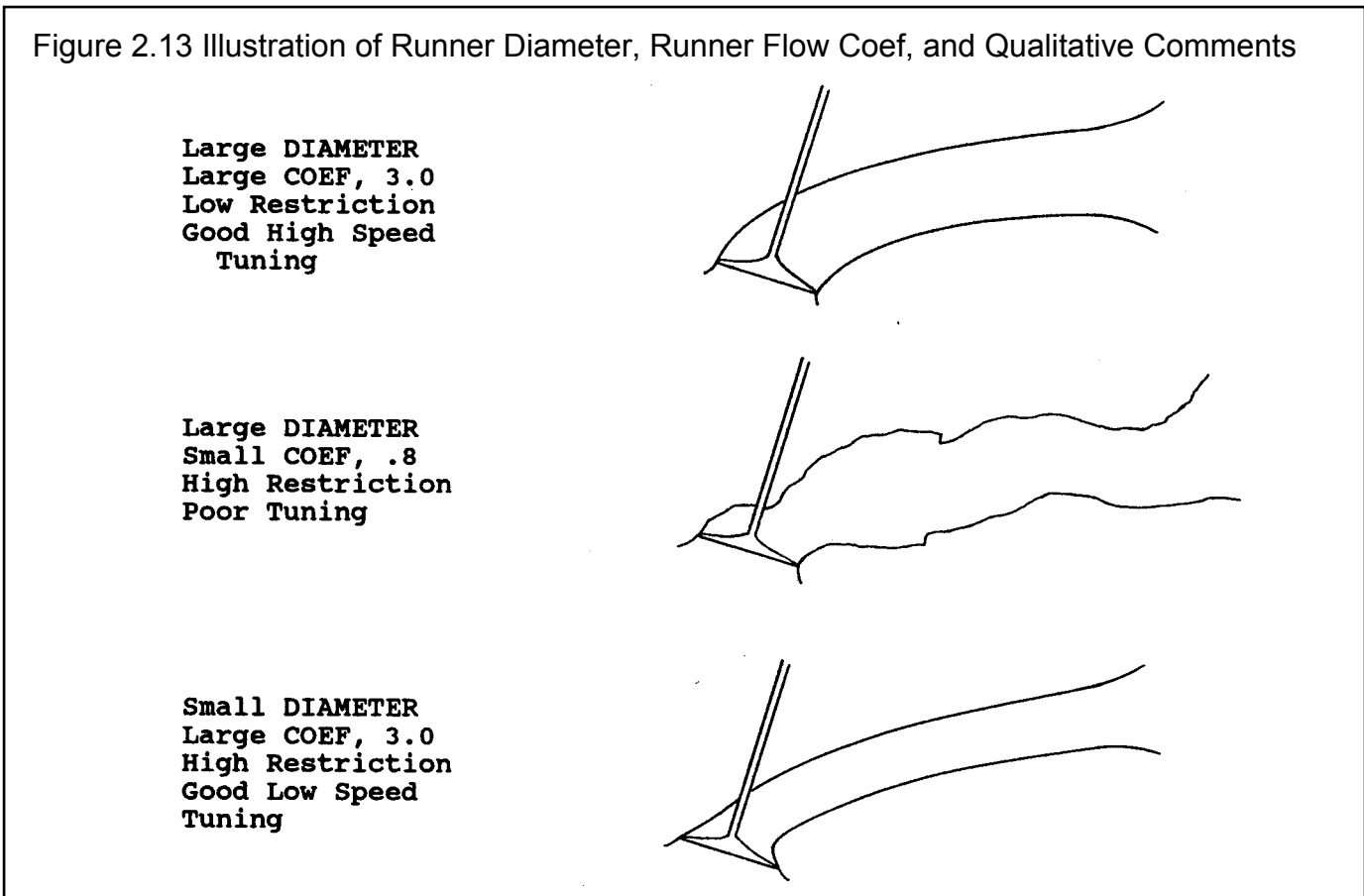

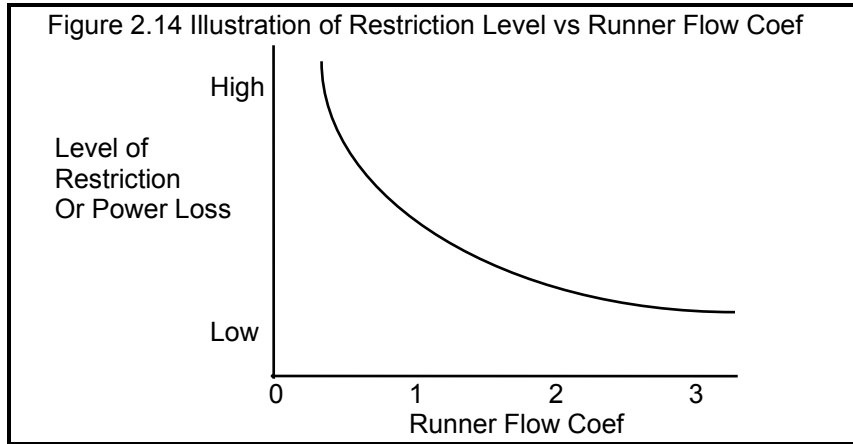

Runner Flow Coef is different from Head(s) Single Flow Coef in 2 ways. First, it is normal to have a Runner Flow Coef greater than 1.0 . Second, Runner Flow Coef has a very "non-linear" relationship to restriction. This means that the difference in restriction between flow coefficients of .5 to 1.0 is much greater than the difference between 2.5 and 3.0. Figure 2.14 shows that most change in restriction level occurs between Runner Flow Coefs of .5 and 1.5.

Runner Flow Coef not only affects flow restriction, but has an influence on intake tuning. See Appendix 3 and Example 4.5.

See Section 2.9.7 for how to calculate Runner Flow Coef from flow bench data. Even if you do not have flow bench data, review Section 2.9.7 for an understanding of how the flow capacity of the head's ports relate to the intake manifold's Runner Flow Coef.

Manifold Type

This combo box lets you pick the type of intake manifold design and the type of fuel delivery system. This will determine what percent of the carburetor or throttle body is available to each individual cylinder and the type and strength of the intake tuning effects.

Table 2.8 Descriptions of Manifold Types

Manifold Type	Description
Dual Plane - carb(s)	This manifold type is where half of the engine's cylinders "see" only half of the carburetor and are isolated from the other half of the cylinders. This type of manifold gives a stronger fuel metering signal at low speed, because each induction pulse goes to a carburetor only half as big as the entire carburetor. Most production carburetor systems are of this type for engines larger than 4 cylinders. Dual plane intakes on engines with 6-10 cylinders also exhibit some "secondary" or low speed tuning effects. See Appendix 3 and Example 4.1. A carburetor is the fuel metering device.
Single Plane - carb(s)	A single plane manifold is where all cylinders can draw from all carburetor barrels. For this reason, this manifold offers lower flow restriction at higher air flows (high RPM). These types of intakes on V- 8s tend to have shorter runners than either dual plane or tunnel ram manifolds. A "Street" single plane is one where tuning has been compromised to also provide hood clearance, good part throttle fuel distribution, good throttle response and cold weather operation, etc. Also see Tunnel Ram - carb(s) below. Single plane intakes on engines with 2-4 cylinders also exhibit "secondary" or low speed tuning effects. See Appendix 3 and Example 4.1. A carburetor is the fuel metering device.
Tunnel Ram - carb(s)	This type of single plane manifold has been designed for optimum intake tuning and low flow restriction. See Figure 2.16. Single plane intakes on engines with 2-4 cylinders also exhibit "secondary" or low speed tuning effects. See Appendix 3 and Example 4.1. A carburetor is the fuel metering device.
Single Plenum - EFI	This type of production intake system is characterized by one injector dedicated to each cylinder and one large plenum which supplies air to all cylinders. Generally these intakes have been optimized for tuning effects, since fuel distribution and carb

	"pump shot" lag are no longer a concern. These systems generally have runner lengths in the 8 to 20 inch range. Injected intakes on engines with from 2-4 cylinders also exhibit "secondary" or low speed tuning effects. See Appendix 3 and Example 4.1. Fuel injection is the fuel metering device and a throttle body meters air.
Split Plenum - EFI	This type of manifold is very similar to the Single Plenum-EFI above except it has a split plenum, each side supplying air to only half of the cylinders. This type of fuel injected intake is usually used on engines with 6 or more cylinders to produce "secondary" tuning effects for improved low speed torque.
Ind Runner - carb(s)	This manifold type has all cylinders completely isolated from one another. This type of system generally offers the best potential for intake tuning. However, these systems can be restrictive, even with a large Total CFM Ratings. For example, each cylinder can draw from a 600 CFM carb on a single plane, V-8 manifold. However, each cylinder could only draw from a 75 CFM carburetor (one eighth of 600 CFM) with an individual runner system with a Total CFM Rating of 600. Individual runner manifolds will exhibit no "secondary" or low speed tuning effects. If you specify # Of Cylinders as 1 in the Short Block specs, the program assumes an individual runner system, no matter what type is selected here. This system uses carburetors as the fuel metering device.
Ind Runner - fuel inj	This type is like Ind Runner - carb(s) except fuel injection is the fuel metering device and individual port throttles meter air.

Runner Taper, deg

Is the taper on the runner. If the runner is of constant cross sectional area, it would have zero taper. If the angle for *all* sides is 1 deg from being straight, this would be a 2 degree taper. If 2 sides are straight and 2 sides are tapered 1 degree from straight, this would be something less than 2 degrees of taper. This can be confusing, so the best way to estimate runner taper is to click on the Clc button and calculate taper based on simpler inputs as shown in Section 2.9.8.

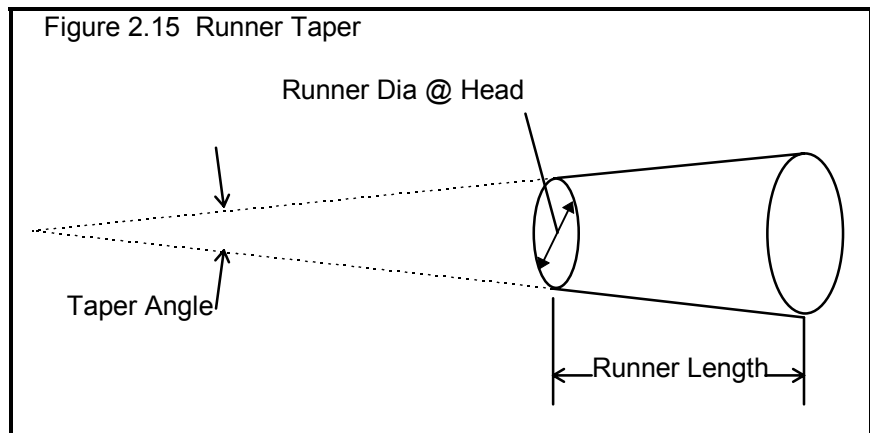

Intake Heat

This combo box lets you pick the method of heating the intake manifold for improved fuel atomization, fuel distribution and cold weather operation. Use the Table 2.9 to estimate Intake Heat.

Table 2.9 Descriptions of Intake Heat Ratings

Description	Type of Intake Heat
Production carbureted manifolds heated by exhaust gas and/or engine coolant.	Prod (full heat)
Production individual cylinder fuel injection manifolds or carbureted manifolds with blocked exhaust crossover.	Reduced Heat
Manifolds with no source of engine heat; fuel injection or carbs with individual stacks; manifolds which have no coolant passages, exhaust crossover, and are insulated or isolated from the lifter valley.	No Heat

Fuel Delivery Calculations

- Yes
 No

If you choose Yes for Fuel Delivery Calculations, as shown above, the See Specs button becomes enabled. Click on this button to view a new menu of fuel delivery system (carb or electronic fuel injection) details. See Fuel Delivery Specs in the next section. These specs have NO effect on performance but just the fuel delivery recommendations given in the test results.

Carburetor(s) Throttle Body(s)

The title of this section of the Intake System Specs menu is determined by the choice of Manifold Type.

Total CFM Rating

Is the air flow rating of the carburetor(s), or throttle body(s) if the engine is fuel injected. The flow rating is measured in CFM (Cubic Feet per Minute) maintaining a 1.5" Hg (inches of mercury) pressure drop across the carburetor or throttle body. Standard CFM at 1.5" Hg pressure drop (20.4" water is the standard method of rating 4 BBL carburetors. Standard CFM ratings for 2 BBL and 1 BBL carburetors are measured with a 3" Hg pressure drop and must be converted to the 4 BBL rating before they will be accurate in the Engine Analyzer Pro program. Use the .71 conversion as shown below:

$$2 \text{ BBL CFM Rating} \times .71 = 4 \text{ BBL CFM Rating}$$

This spec has a Calc button, which means you can calculate it from either:

- Throttle bore sizes, # throttle bores, restrictor plate specs.
- Flow bench data.

See Section 2.9.9 on these options.

Secondary Throttles

This combo box identifies if the carburetor (or on rare occasions, the throttle body) has additional air flow capability at high air flow demands:

- If there are no secondary throttles, pick the first choice "No Sec Throttles".
- If there are secondary throttle plates, check to see if they are mechanical secondaries. With the engine not running, see if all throttle plates are completely open with the throttle linkage in the WOT (Wide Open Throttle) position. If so, pick the "Mech Sec Throttles".
- If there are throttle openings which are not completely open, but which open "on demand" when engine air flow requirements increase, pick one of the other choices by estimating the RPM where they will open.

Note: If you have chosen Yes for Fuel Delivery Calculations and are using a carbureted Manifold Type, be sure you have specified the Fuel Delivery spec "# Secondary Venturis" as a number greater than 0.

Air Clnr Flow Rating

Is the flow rating of the air cleaner filter element and housing measured in CFM with a pressure drop across the air cleaner of 3" water. Since this spec has a Clc button, you can calculate an air cleaner flow rating from air cleaner dimensions. See Section 2.9.10. If no air cleaner is used, enter a very high flow rating, for example 100000 CFM.

Plenum Specs

- Guess at Specs
- Use Specs Below

The intake manifold's plenum is the volume directly after (under) the carb or throttle body before the air passage splits into the individual runners to each cylinder. The large "box" under the carbs on a Tunnel Ram manifold is a good example of a large plenum. Because plenum and secondary runners (the carb or throttle body dimension) specs are new to many users of the Pro, and for many engine combinations these specs usually have very little effect on performance, you may want to simply choose the Guess at Specs option. This tells the program to use reasonable estimates of these plenum and secondary runner specs. If you want to specify plenum specs, you must choose the Use Specs Below option button first. Then these specs become enabled so you can change them.

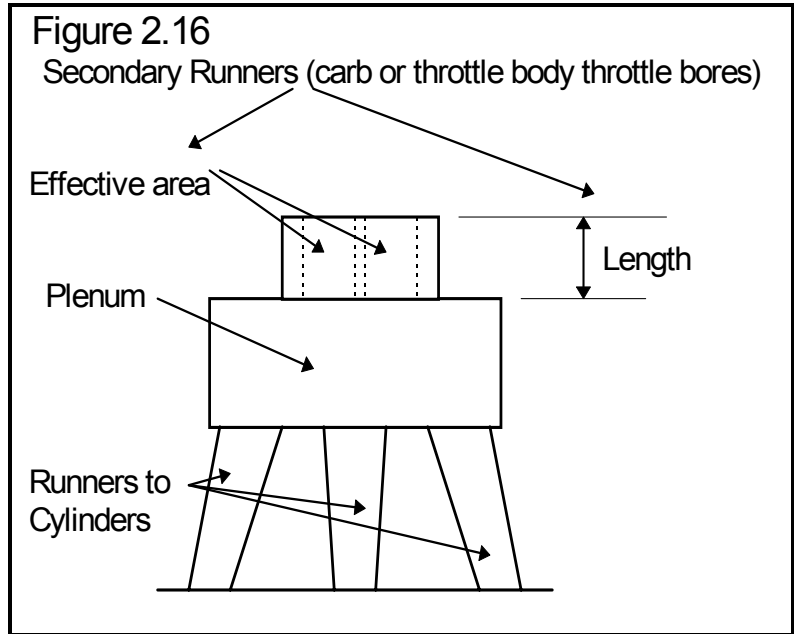

Note: Depending on the Manifold Type in the Intake System Specs menu and # of Cylinders in the Short Block Specs menu, some or all of the plenum specs may be disabled. For example, if you have chosen Ind Runner - carbs, there is no plenum. Plenum Specs are disabled, you can not change them, and they are not used in the calculations.

Plenum Volume

Is the volume of the plenum in cubic inches. It does not include the dimensions of the runners to the cylinders or any portion of the carb or throttle body or spacer which is approximately the same size as the throttle bores. If the spacer is much larger than the throttle bores, like one single, large rectangular hole under a 4 barrel carb, then include the volume of the spacer in the plenum volume. Click on the Clc button to calculate this volume from simple dimensions. See Section 2.9.11.

Effective Carb Length, in Effctv. Thrttl Bdy Len, in

Is the length of the carb or throttle body throttle bores and any ducting before and after the throttle bores which are approximately the same diameter as the throttle bores.

Carb Area, sq in Throttle Body Area, sq in

Is the total area of the carb or throttle body throttle bores and any ducting before and after the throttle bores which are approximately the same diameter as the throttle bores. Click on the Clc button to calculate from simpler specs.

2.4.1 Fuel Delivery Specs

The specs in this menu only affect the recommended fuel settings in calculated performance, not any of the power calculations. Recommended fuel settings in the test results include:

- Primary Jet and Secondary Jet if carbureted
- Injctr Dty Cyc and Inj Plse Wdth if fuel injected

The Pro assumes a 12.5 A/F for gas or a 5.0 A/F for alcohol is delivered regardless of how these specs are set. If you are using the Engine Analyzer Pro only for predicting performance, you should select No for the Fuel Delivery Calculations in the Intake System Specs menu shown in Figure 2.12. Then you can disregard setting any of these specs. In that case, the test results of Primary Jet, Secondary Jet, Injctr Dty Cyc and Inj Plse Wdth are left blank. Figure 2.17 shows the Fuel Delivery menu which is displayed if you click on the See Specs button in the Fuel Delivery Calculations section in the Intake System Specs menu.

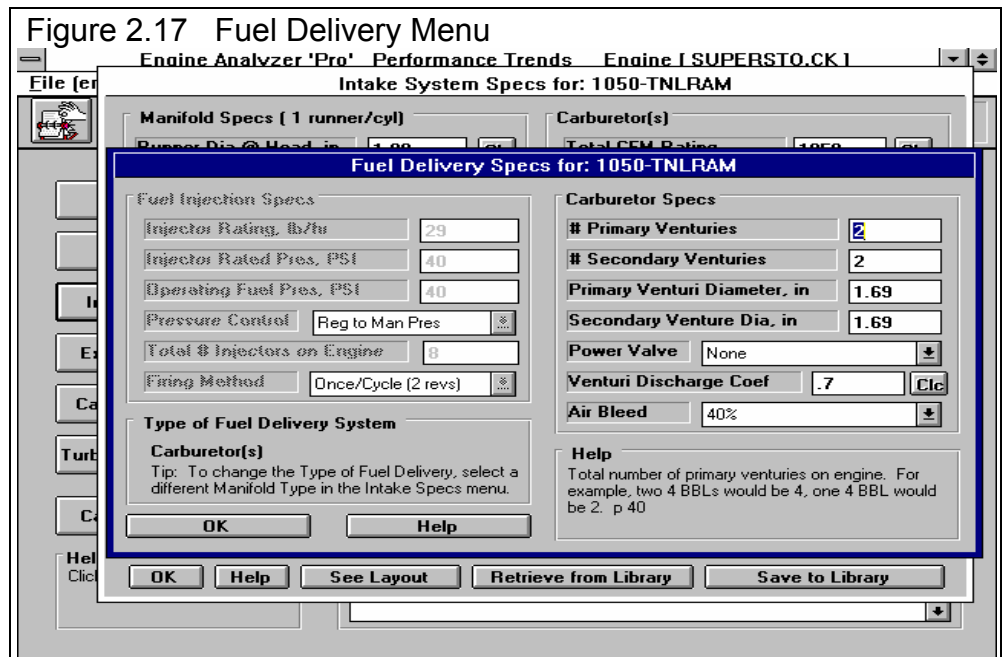

Fuel Injection Specs

Injector Rating, lb/hr

Is the "full open" fuel flow rating of one injector in pounds per hour for the particular fuel being used. Therefore, for alcohol engines, the injector rating, lb/hr should be for flowing alcohol. Many times people simplify this term and say for example "30 lb injectors". This usually means 30 pounds per hour.

Injector Rated Pres, PSI

Is the fuel pressure in PSI at which the Injector Rating is rated.

Operating Fuel Pres, PSI

Is the operating fuel pressure delivered to the injector when installed on the engine. For example, say an injector is rated at 30 lb/hr with a Injector Rated Pres of 40 PSI. If you run it on the engine with an Operating Fuel Pres of 60 PSI, it will flow much more than 30 lb/hr. Many times the operating pressure is increased to provide enough fuel for supercharged engines.

Pressure Control

This combo box lets you select the method used to control Operating Fuel Pres. If the fuel pressure is regulated to manifold vacuum or pressure, select “Reg to Man Pres” or “Reg to Boost Pres”. (The Boost Pres item means exactly the same as Man Pres, but we thought some people may recognize the word “Boost” and not “Man.”) This type of system usually has a vacuum line connected from the fuel pressure regulator to the intake manifold. If you measure fuel pressure with a gauge, you will see regulated fuel pressure increase as you open the throttle and manifold pressure increases (manifold vacuum drops). This type of system generally holds a constant pressure drop across the injector. Therefore, fuel flow will not change with manifold pressure changes unless the electrical signal to the injector changes.

If the pressure is regulated to atmospheric pressure or simply has a regulator which holds a constant pressure, choose “Hold Const. Pres”. These types of systems hold fuel pressure constant no matter what the manifold pressure or supercharger boost.

Total # Injectors on Engine

Is the total number of injectors on the engine. The program assumes all injectors are identical and operate the same.

Firing Method

Is the number of times one injector fires in one complete engine cycle (2 revolutions or 720 degrees). Most systems with 1 injector for each cylinder fire the injectors only once each cycle so choose “Once/Cycle (2 revs)”.

Carburetor Specs

The Engine Analyzer Pro lets you simulate some basic carburetor operation to understand how engine and carburetor modifications affect carburetor performance. Carburetors are nearly as complicated as the engine itself. Many simplifying assumptions are made to reduce the carburetor specs to those you see here. Most assumptions are based on a typical Holley 4 barrel.

WARNING: *Although recommended jet sizes may work well in some cases, DO NOT use them to jet your carb. Due to the many carb assumptions made by the Pro, recommended jet sizes should only be used to show trends.*

Primary Venturis

Is the total # of primary carburetor venturis on the engine. Table 2.10 gives some examples.

Table 2.10, Examples of # Primary Venturis and # Secondary Venturis

Intake System	# Primary Venturis	# Secondary Venturis
Single 4 barrel carb	2	2
Dual 4 barrels	4	4
Three 2 barrel carbs, (ex. Mopar "Six Pack")	2	4
Four cylinder engine with Ind Runner	4	0
"Non Staged" 2 barrel carb (ex. Holley 500)	2	0
Staged 2 barrel carb (Ford 2300, Pinto 2 barrel)	1	1

Secondary Venturis

Is the total # of secondary carburetor venturis on the engine. Table 2.11 gives some examples.

Primary Venturi Diameter, in

Is the diameter of the main venturi (not booster venturi) in a primary throttle bore in inches. This is not the throttle plate diameter.

Secondary Venturi Diameter, in

Is the diameter of the main venturi (not booster venturi) in a secondary throttle bore in inches. This is not the throttle plate diameter.

Power Valve

This combo box lets you pick the diameter of the power valve restrictor channel in inches, and whether the power valve is only for the primaries or for both the primaries and secondaries. For some diameters, an example is given, however, your particular carb may be different.

Venturi Discharge Coef

Describes the strength of the fuel metering signal generated by the carburetor booster venturi. Most carburetor booster venturis have a discharge coefficient of approximately .75. Special "high strength" boosters, Holley's "annular discharge" booster, double boosters (a booster venturi within a booster venturi) will have CD's of .55 to .65. The lower the number, the higher the booster signal (the more venturi suction) for a given air flow.

If you have flow bench data of venturi signal for various amounts of air flow through the carb, click on the Clc button to calculate venturi CD. See Section 2.9.13.

Note: Many carbs will have different venturi CDs on the secondary venturis than the primary venturis. Use the average of the primary and secondary CDs for venturi CD if you calculate it from flow bench data. Also remember that the actual carb will need a larger jet for the venturis with the larger CDs. Differences between primary and secondary venturi CDs are not accounted for in the program.

Air Bleed

This combo box lets you pick the approximate size of the air bleed for the primary (and secondary) metering systems. The actual carburetor's air bleed rating, % is nearly impossible to determine except under actual running or "wet flow bench" testing. Use this parameter only to understand how the air bleed system works. An air bleed rating, % of 0 would be no air bleed opening. An air bleed rating, % of 100% would be for an air bleed orifice approximately as large as the main jet.

Notes: The air bleed rating is the only carburetor spec which can not be measured directly. Therefore, set all other carb specs including calculating the venturi CD from flow bench data. Then adjust the air bleed rating until the Primary Jet and Secondary Jet match the diameters of the metering jets you are using (assuming the jets you are using give 12.5 A/F for gas or 5.0 A/F for alcohol).

The goal of most carburetors is to deliver the same A/F for all RPMs. You'll know if you have reached this goal if the Primary Jet and Secondary Jet are nearly the same at all RPMs. By adjusting the venturi CD and air bleed rating, you can usually obtain a nearly constant Primary Jet and Secondary Jet. Restricted engines (engines where class rules dictate a carb much smaller than optimum) usually require more air bleed rating and a higher venturi CD (less metering signal) for constant Primary Jet and Secondary Jet (and constant A/F) at all RPMs.

Many carbs will have different air bleeds on the secondary venturis than the primary venturis. This detail is not accounted for in the program.

See Example 4.1, "For Advanced Users" for more detail.

2.5 Exhaust System Specs

The Exhaust System specs affect exhaust system tuning and flow losses due to restrictions in the exhaust manifold or header and exhaust/muffler system.

Exhaust System Specs have been expanded in later versions. See Appendices 9 - 13 on pages 235-312 for more updated info.

Header Primary Specs (x rnr/cyl):

The "x rnr/cyl" depends on the current value of # Valves/Ports under Exhaust Port specs in the Head(s) menu. If x=2 or 3, then the Header Specs of Design, Inside Dia at Head, Total Length, Runner Flow Coef and Inside Dia at Exit describe only 1 of the 2 or 3 exhaust header or manifold runners for each cylinder.

Important: Click on the See Layout button at the bottom of this menu to see how your input specs are being used by the program.

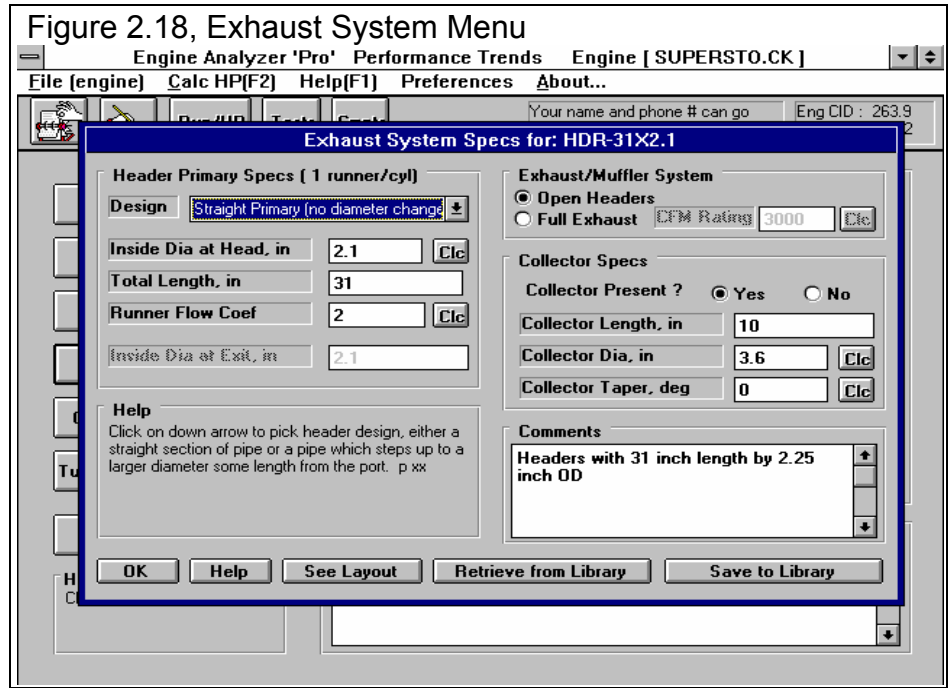

Figure 2.18, Exhaust System Menu

Design

This combo box lets you pick the general design of the exhaust runner:

- Straight with no diameter change from the head to the collector or exit to atmosphere
- Constant taper from the head to the collector or exit to atmosphere
- Stepped, with a relatively small diameter change at some distance from the head

Inside Dia at Head, in

Is the inside diameter of the header or exhaust manifold runners at the head. If you know your header tubing outer diameter, simply subtract .1 inches to obtain the approximate inside diameter For example:

1 7/8" Headers: Tubing O.D. = 1.875

Inside Diameter = 1.875 - .1 = 1.775

If the runners are oval or rectangular or you have runner volume in CCs (usually used only for exhaust manifolds), click on the Clc button to calculate the effective diameter. See Section 2.9.3,

Note: The exhaust runner dimensions are not as critical as the intake runner dimensions. It is generally "overkill" to "cc" the primary header pipes. Simply estimating the inside diameter by subtracting .1 from the tubing OD is adequate.

Total Length, in

Is the length of the exhaust runner from the exhaust port in the head (not including the exhaust port) to the first "abrupt enlargement" of the runner downstream of the exhaust port. The "abrupt enlargement" can be several different things:

- The header collector where individual tubes merge together.
- The end which is open to atmosphere on individual runner exhaust headers.
- Any point where a runner from one cylinder merges with a runner from another cylinder.

Most production exhaust manifolds have runners 2 to 8 inches in length. Production manifolds and headers for performance engines generally have longer runners to take advantage of exhaust tuning effects, 12-24 inches. Aftermarket headers generally have a length of 20-40 inches.

Runner Flow Coef

Is similar to the Runner Flow Coef discussed in the Intake System section. Runner Flow Coef mostly affects flow restriction and only slightly affects exhaust tuning. (This is a change from Version 1.2 where this parameter had a stronger influence on exhaust tuning.) See Appendix 3 and Example 4.5.

See Section 2.9.7 for how to calculate Runner Flow Coef. Even if you do not have flow bench data, review Section 2.9.7 for an understanding of how the Valve and Runner Flow Coefs relate to each other. If you do not have flow data, use Table 2.11 to estimate the Runner Flow Coef for typical exhaust manifolds and headers.

Table 2.11, Estimate Exhaust Runner Flow Coef

Description	Typical Runner Flow Coef
Production, non performance manifolds	.7 - 2.0
Production, performance manifolds with longer runners, smooth bends	1.0 - 2.0
Aftermarket, "street" headers (typically more bends to clear frame, provide for easy installation, etc.)	1.0 - 2.5
Aftermarket, "race" headers (designed primarily for low restriction, good tuning characteristics)	1.5 - 3.0

Exhaust/Muffler System

- Open Headers
- Full Exhaust

Click on the option button which describes your exhaust system. If you choose Open Headers, the CFM Rating spec is disabled, because that is the CFM Rating of the exhaust system, not the headers.

CFM Rating

Is the "vehicle exhaust system and muffler restriction rating" and describes the design of the exhaust system. It is very similar to a carb or throttle body Total CFM Rating in the Intake System Specs menu.

The CFM Rating is measured in CFM (Cubic Feet per Minute) maintaining a 1.5" Hg (inches of mercury, or 20.4 inches of water) pressure drop across the entire exhaust system. Exhaust system flow data is becoming more common in magazine articles and performance "how to" books. However, the pressure drop used for doing the flow tests may not be 20.4". If not, use the following formula to obtain CFM flows corrected to 20.4":

$$CFM @ 20.4" = CFM @ XX" \times \sqrt{\frac{20.4}{XX}}$$

Where XX is the actual test pressure in inches of water

Also, if they flow each side of the exhaust system separately, simply add the two CFM values obtained.

For example, a magazine article says the right side of a particular exhaust system flows 270 CFM at 28" water.

First, convert 270 CFM @ 28" to CFM at 20.4"

$$CFM @ 20.4" = 270 * \frac{\sqrt{20.4}}{\sqrt{28}} = 270 * .854 = 230 \text{ CFM}$$

Second, add left and right side flows together to obtain total exhaust system flow (assuming the left flows equal to the right)

Total flow = Lt flow + Rt flow = 230 + 230 = 460 CFM

If you do not have flow data, use Table 2.12 to estimate the CFM Rating or click on the Clc button to calculate CFM as explained in Section 2.9.14.

Table 2.12, Estimate CFM Rating

Designed Engine Power in Horsepower	CFM Rating		
	Quiet	Sporty	Race
0 - 50	20	40	120
51 - 100	60	120	360
101 - 150	100	200	600
151 - 200	140	280	840
201 - 250	180	360	1080
251 - 300	220	440	1320
301 - 400	280	560	1680
401 - 600	400	800	2400
601 - 1000	640	1280	3840
1000- 2000	1200	2400	7200

Definitions for Table 2.12:

- Quiet is a production exhaust system for a family sedan or luxury sedan where a "throaty" engine roar is undesirable.
- Sporty is a production exhaust system for performance/sports cars.
- Race is an exhaust system with extremely low back pressure, designed for classes of racing where rules require mufflers.
- For open headers/no exhaust system, enter a very large value of CFM, for example 100000 CFM.

Note: As a double check, this is the range of Exhaust Back Pressures (Exh Pres) you should obtain when calculating performance for the various CFM Ratings:

Quiet	= 7 to 12 PSI at the RPM for peak HP
Sporty	= 2 to 8 PSI at the RPM for peak HP
Race	= .5 to 3 PSI at the RPM for peak HP
Open Headers	= 0 PSI

If you have the exhaust system mounted on the engine you are simulating with the Pro', you can verify the CFM Rating by actually measuring the exhaust pressure in PSI. Weld a hose fitting to the exhaust pipe as close as practical to the header or manifold. Attach a hose from the fitting to a **TEMPORARY** pressure gauge **OUTSIDE** the vehicle. For example, tie it to a windshield wiper so it can be read inside the car. The gauge should be for reading low pressures, like 5 PSI full scale for accurate measurements. Make a full power acceleration in the vehicle and see if the measured pressure matches the Pro's Exh Pres.

SAFETY NOTE: Do not run an exhaust pressure line into the car. This is to prevent carbon monoxide poisoning.

Collector Specs

- None
 Simple
 Detailed

Click the appropriate option button for your exhaust system design and for the level of detail (and calculation time required) in the calculations. See the definitions below:

- None says each exhaust header empties separately to atmosphere, like "zoomies" on a blown, nitro dragster. Selecting this options disables all collector specs.
- Simple says each exhaust header combines into a common pipe of large diameter, usually called a collector. For engines with # of Cylinders greater than 5, the Pro assumes there are 2 collectors, each with half of the header pipes from engine's cylinders. Selecting this options disables collector diameter and taper angle. During development it became evident that the collector specs were having too much effect on the results. In actual engines, the size and length of the collector generally is not too critical. Therefore, to simplify the calculations (which saves considerable calculation time) and produce results more in line with typical engines, we developed this option.
- Detailed says each exhaust header combines into a common pipe of large diameter, usually called a collector. For engines with # of Cylinders greater than 5, the Pro assumes there are 2 collectors, each with half of the header pipes from engine's cylinders. Selecting this options enables all collector specs. Generally selecting this option will let the collector have too much effect on calculated performance. In actual engines, the size and length of the collector generally is not too critical. This option can be useful for those who want to see how collector specs should effect performance, and at what RPMs. However, you must keep in mind if a change shows a 40 HP change at a particular RPM, that the real change may be more like 5 HP instead. This option can also be useful for "cutting edge" engines like Pro Stock or Formula 1. For these highly tuned engines, collector specs may have more effect, like that shown by the program. More refinements will be made as we gain more experience.

Collector Length, in

Is the length of the collector from the end of the header primary or exhaust manifold runner to the next abrupt enlargement. This abrupt enlargement is usually the opening to atmosphere for open headers. For exhaust systems, it would usually be the catalyst or muffler.

Collector Dia, in

Is the diameter of the collector at the end which attaches to the header primary(s) or exhaust manifold runner(s). You can click on the Clc button to have the program estimate the Collector Dia based on the diameter of the header primary(s) or exhaust manifold runner(s), their number and a percent change in cross sectional area. Click on the Clc button to calculate a diameter from the Header Primary Diameter specs as explained in Section 2.9.15.

Collector Taper, deg

Is the angle for the taper of the collector. For collectors with no area change (straight, constant diameter pipe), enter 0. For collectors which taper out (larger diameter or area at the exit of the collector) enter the number of degrees. Although this would be rather unusual, enter a negative number (-) of degrees if the collector gets smaller at the exit. Click on the Clc button to calculate the Taper angle based on diameters or areas and collector length.

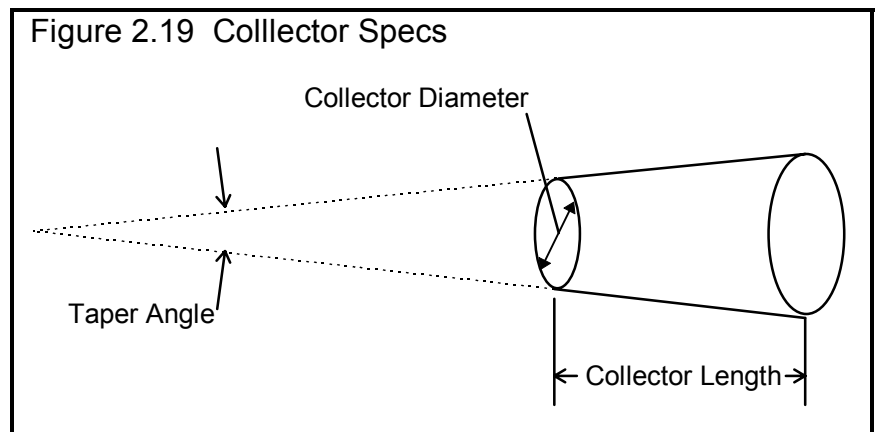

2.6 Cam/Valve Train

Cam Valve Train Specs have been greatly expanded in later versions, with many new inputs and features. See Appendices 9 - 13 on pages 235-312 for more updated info.

The Cam/Valve Train specs describe the opening and closing of the valves, valve train weights, spring rates and stiffness of components. Because there are so many different ways of specifying cam specs, the Pro includes a menu called Alternate Cam Specs. Click on the See Alternate Specs button at the bottom of the screen if you have specs which do not match those shown in the main Cam/Valve Train menu shown. This Alternate Cam Specs menu is discussed later in this section.

Note: Alternate Cam Specs were incorporated into the main Cam Screen in v3.3 because computer screen resolutions increased. This allowed more info to be displayed on one screen.

Cam and valve train specifications are critical to engine performance; therefore reliable information is necessary. It is recommended that you use specifications given by the cam grinder or engine manufacturer. Actual measurements of cam and valve train specifications can be done, however this can be tricky and therefore is recommended to have someone experienced perform them. Guides for making these measurements are also available from cam grinders and manufacturers of valve train components and are beyond the scope of this User's Manual.

For additional reference, see Example 4.2 and Appendix 8. Performance Trends' Cam Analyzer program can help you to make these measurements. It can also be used to create Cam Dr (tm) files, which can be used by the Pro for detailed analysis of a particular cam profile. See Cam File on page 43 for using Cam Dr (tm) files.

Version 3.9 allows you to communicating directly with the Cam Analyzer, allowing for much easier importing of cam files from Cam Analyzer.

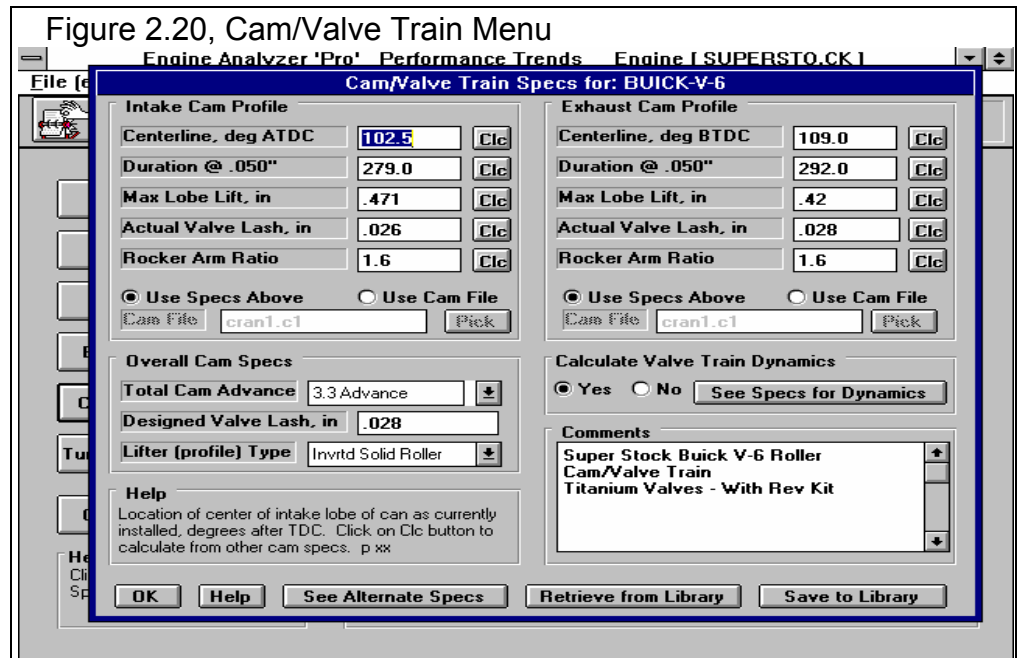

Figure 2.20, Cam/Valve Train Menu

Intake Cam Profile

Centerline, deg ATDC

Is the location of the maximum lift point on the cam profile. If you are using the program's standard cam profiles, this is also exactly half way between the open and closing point because the program assumes the same opening and closing profile. This is not necessarily the case if you use a Cam File, which may have very different opening and closing profiles. Click on the Clc button or the See Alternate Specs button at the bottom of the menu to bring up the Alternate Cam Specs menu. There you can enter Opening and Closing events at .050" lift instead of Centerline and Duration. Also see Appendix 8 and Example 4.2.

Duration @ .050"

Is the number of crank degrees where the tappet is lifted at least .050 inches above base circle. This will correlate to most cam grinder's spec of "duration @ .050 inches lift". This has become an aftermarket standard. Be sure not to use "seat timing" or "advertised duration", as these are usually much larger numbers. Click on the Clc button or the See Alternate Specs button at the bottom of the menu to bring up the Alternate Cam Specs menu. There you can enter Opening and Closing events at .050" lift instead of Centerline and Duration. Also see Appendix 8 and Example 4.2.

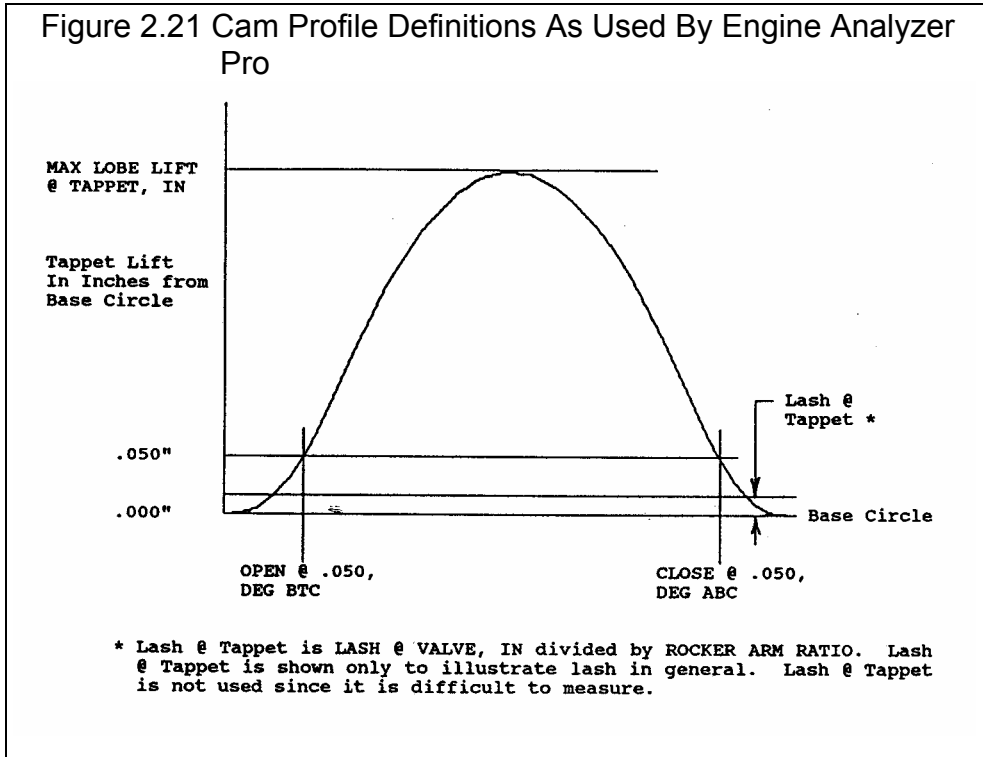

Max Lobe Lift, in

Identifies how high the cam lobe lifts the tappet above Base Circle in inches. If you are given "gross valve lift" by the cam grinder, divide by the rocker arm ratio *assumed by the cam grinder* to obtain gross or maximum tappet lift. This can also be done in the Alternate Cam Specs menu. Click on the Clc button or the See Alternate Specs button at the bottom of the menu to bring up the Alternate Cam Specs menu. Also see Appendix 8 and Example 4.2.

Actual Lash @ Valve, in

Identifies the lash or clearance in inches between the valve tip and its actuator, generally the rocker arm. If you have specified a hydraulic Lifter (profile) Type, this spec is disabled.

Notes: This spec works with the Designed Valve Lash spec. If you specify an Actual Valve Lash nearly the same as the Designed Valve Lash, the valve will be opened as the cam profile was designed. If you specify a smaller Actual Valve Lash than the Designed Valve Lash, the valve will be opened longer and higher than what the cam was designed for. And vice versa, if you specify a larger Actual Valve Lash than the Designed Valve Lash, the valve will be opened less time and less lift than what the cam was designed for.

Rocker Arm Ratio

Identifies the ratio between tappet lift and valve lift. Generally rocker arm ratios vary between 1.3 to 1.8. For valve trains with no rocker arms, for example overhead cam systems with directing acting tappets, enter 1. See Figure 2.22. The Pro assumes the ratio is constant although actual rocker arm ratios vary slightly with valve lift.

Figure 2.22, Various Valve Train Designs & Estimated Rocker Arm Ratios

**Pushrod
Overhead Valve**

R.A.R. = 1.3-1.7

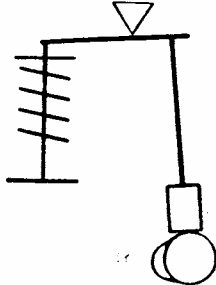

**End Pivot
Overhead Cam**

R.A.R. = 1.3-1.7

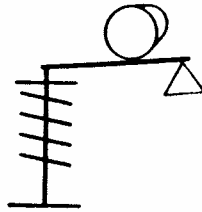

**Direct Acting
Overhead Cam**

R.A.R. = 1.0



Use Specs Above Use Cam File

Cam File

The Engine Analyzer Pro allows you to specify the cam lobe at every 2 crank degrees (1 cam degree) by reading several different types of cam files. These files include "Cam Dr (tm)", "Competition Cams (tm)", "Doctor Dr (tm)" and "S96 (tm)" files. Although, the Pro can approximate most cam profiles quite closely from just the simple specs described above, this is the only way to simulate the *exact* cam profile you are using.

If you have a cam lobe data file you want to use, choose the Use Cam File option button. This will disable some specs in the Cam/Valve Train menu and enable the Cam File Pick button. Click on the Pick button and a standard Windows menu opens so you can pick any file any place in the computer. Find the file and click OK. The program will warn you if it is not a file format it recognizes. The file name and path will be loaded into the Cam File text box. You can not change this name in the text box directly, but only by using the Pick button. See Example 4.2.

Cam Dr (tm) files usually end with ".cxx" where xx is the cylinder #. Each Cam Dr file consists of an intake and exhaust lobe. The Engine Analyzer Pro will only read the intake lobe data as an intake lobe and the exhaust lobe data as an exhaust lobe for the calculations. However, you can use one cam data file for the intake profile and a different one for the exhaust profile.

Complete Cam Dr files also include ".des" and ".msu" files which include comments, camshaft data, rocker arm ratio, etc. Because the Pro already knows lobe center, rocker arm ratio, etc., these additional files are not needed. Performance Trends' Cam Analyzer computer program can create Cam Dr (tm) files from dial indicator and degree wheel readings. Contact Performance Trends for more information.

Competition Cams files are only for 1 lobe, and can be used for either intake or exhaust. The format for a Competition Cams file is relatively simple:

The first 42 records or lines are simply text or comments, and are ignored by the Engine Analyzer Pro

The next 360 records are cam degrees and cam lift, for example:

```

1 .000
2 .001
3 .003
. .
. .
359 .000
360 .000

```

The cam degrees are not used, but a number must be included at this location. The cam lift data can start at any place, even in the middle of a lobe. The minimum lift (base circle) need not be zero, but can be either above or below zero. Because the Competition Cams format is simple and very general, experienced computer users may be able to write these lobe files from other data or specs they have.

Overall Cam Specs

Total Cam Advance

This combo box lets you either pick an advance, retard or “straight up” cam timing by clicking on the arrow key, or you can type in an advance or retard in degrees directly. If you just enter a number, a number with a + sign (ex. +4) or a number followed by the letters “adv”, the program assumes it is number of degrees of cam advance. If you just enter a number with a - sign (ex. -4) or a number followed by the letters “ret”, the program assumes it is number of degrees of cam retard.

Total cam advance is based on the current Intake and Exhaust Centerlines. If the centerlines are equal, Total Advance is set to 0 or straight up by the program. ***This is a major change from version 1.1 and 1.2*** where the spec Additional Cam Advance was used. In those versions you could specify opening and closing events which would produce a Total Cam Advance of say 4 degrees, but the Additional Cam Advance could be set to 0. This was confusing to users. This new method of using Total Cam Advance should match cam specs used by most cam grinders.

To change cam timing from how it was ground by the cam grinder you will need special set of timing gears or an offset timing pin, key or bushing. In general, advancing the cam will give more lower end torque while giving up some top end HP; and retarding will give up low end torque to gain top end HP.

Designed Valve Lash, in

Is the valve lash the cam grinder recommends you use, or what the cam was ground for. If the cam grinder recommends a different lash for the exhaust than the intake, use the intake lash. See Actual Lash @ Valve a couple pages back.

Lifter (profile) Type

This combo box lets you pick the type of lifter and the “steepness” or “aggressiveness” of the cam’s profiles. The combinations consist of:

Hyd vs Solid	Hydraulic vs Solid lash adjustment
Flat vs Roller	Aggressiveness or steepness of the profile (Roller being more aggressive)
Mild vs Agr	Aggressiveness or steepness of the profile (Agr being more aggressive)
Invrtd	The most aggressive or steep profile (being more aggressive than Mild or Agr)

The choice of Hydraulic vs Solid is the most important as this dictates the use of a lash setting (even if you are using a Cam File) and whether hydraulic lifter pumpup is possible. The other choices simply determine differences in the steepness of the profile

for the same Max Lobe Lift. Most truly aggressive cams or roller cams have more Max Lobe Lift for a given duration, and milder or hydraulic cams have less Max Lobe Lift.

Exhaust Cam Profile
Centerline, deg ATDC
Duration @ .050"
Max Lobe Lift, in
Actual Lash @ Valve, in
 Use Specs Above Use Cam File
Cam File

Definitions for these specs are the same as for the Intake Cam Profile described previously.

Calculate Valve Train Dynamics

Yes No

Select Yes if you want the Engine Analyzer Pro to simulate valve train dynamics (bending and tossing) based on the cam profile, weights, stiffnesses and spring rates entered in the Valve Train Specs menu. This menu is displayed if you choose Yes and click on the See Specs for Dynamics.

Select No and the Engine Analyzer Pro will calculate valve lift exactly as dictated by the cam lobe, lash and rocker arm ratio. The weights, stiffnesses and spring rates in the Valve Train Specs menu are not used. This is recommended if you do not have accurate specs for the valve train. This is similar to a "perfect" valve train with components which have no mass and are perfectly stiff. Eliminating dynamics can give significantly different torque and HP results, usually more HP and less low RPM torque.

2.6.1 Alternate Cam/Valve Train Specs

Note: These Alternate Cam Specs were incorporated into the main Cam Screen in v3.3 because computer screen resolutions increased. This allowed more info to be displayed on one screen. The inputs and outputs show here are now on the main Cam screen.

Shown to the right is the menu for entering alternate cam and valve train specs. Most of these are the same as on the main Cam/Valve Train specs menu and will not be explained again. Only specs which have not been explained

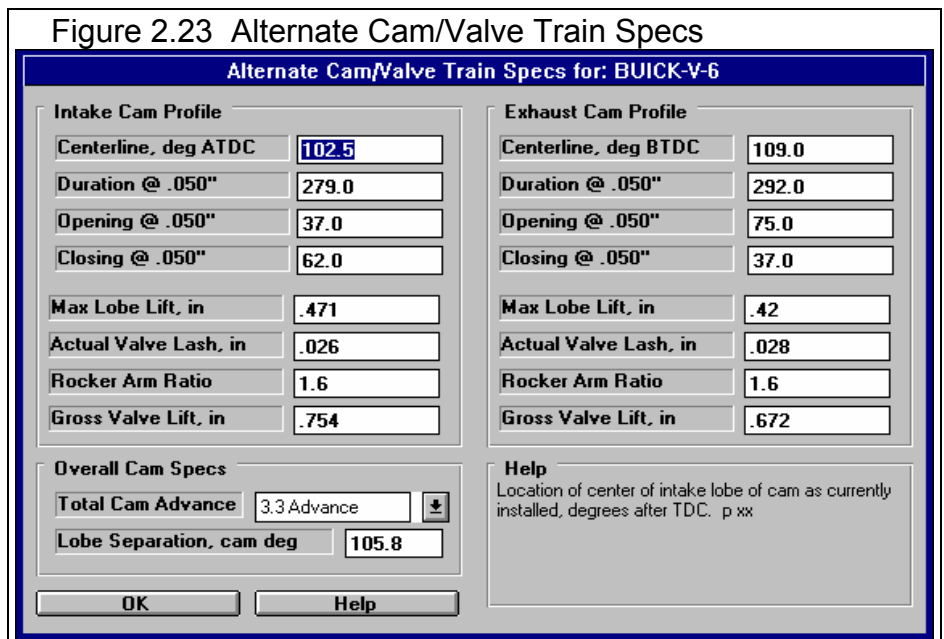

previously in this section will be explained.

This screen is very useful for entering different types of cam specs than what is available in the main Cam/Valve Train menu. This screen will calculate the specs for the main Cam/Valve Train based on these inputs. Examples of these conversions include:

Calculate	From
Centerline and Duration	Opening and Closing
Centerlines	Separation and Advance
Max Lobe Lift	Rocker Arm Ratio and Gross Valve Lift
Cam Advance	One Centerline and Lobe Separation
Centerline	The other Centerline and Lobe Separation

For example, if you know Intake Opening @ .050" and Closing @ .050", you can enter them in this menu to obtain the resulting Intake Centerline and Duration @ .050". When you return to the main Cam/Valve Train menu, the correct Centerline and Duration @ .050" will be transferred from this alternate menu back to the main Cam/Valve Train menu.

Intake Cam Profile

Opening @ .050"

Identifies crankshaft degrees before top dead center where the tappet has been lifted .050 inches above Base Circle on the opening ramp. This value is generally available on your "cam card" or in cam catalogs. If this event occurs after top dead center, enter a negative value. For example, it is reported as 4 degrees after top dead center, enter -4.

Closing @ .050"

Identifies crankshaft degrees after bottom dead center where the tappet has been lowered to .050 inches above Base Circle on the closing ramp. This value is generally available on your "cam card" or in cam catalogs. It is highly unlikely, but if this event occurs before bottom dead center, enter a negative value. For example, it is reported as 4 degrees before bottom dead center, enter -4.

Gross Valve Lift

Is the maximum lift of the valve with NO valve lash (even if it is a mechanical cam with valve lash). Mathematically it is Max Lobe Lift multiplied by rocker arm ratio. This is the standard way most cam grinders rate their cams for valve lift.

Note: If you are not using the same Rocker Arm Ratio as what the cam grinder is assuming, then first enter the cam grinder's Gross Valve Lift and assumed Rocker Arm Ratio. This will give the cam's true Max Lobe Lift. Then change the Rocker Arm Ratio to the actual ratio you are using and you will see Gross Valve Lift change to be correct for *your* rocker arm ratio.

Lobe Separation, cam deg

Is the separation between the intake and exhaust centerlines in *cam* (not crankshaft) degrees, and is the standard method used by most cam grinders.

2.6.2 Valve Train Dynamics Menu

The Valve Train Dynamics menu shown here is displayed if you choose the Yes option for Calculate Valve Train Dynamics and then click on the See Specs for Dynamics. These specs are used to determine the valve train dynamics (bending and tossing) for the engine being tested. (For 4 valve engines, see note on page 49.)

The Valve Train Dynamics Specs have been greatly expanded in later versions, with many new inputs and features. See Appendices 9 - 13 on pages 235-312 for more updated info.

Enterprise Edition adds even more details to simulate Valve Spring Dynamics. See Appendix 13.

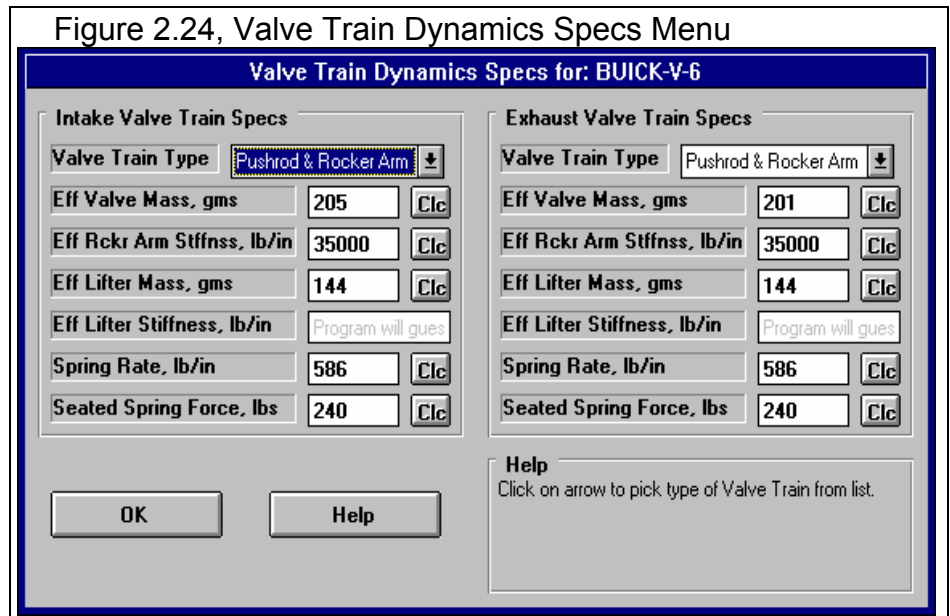

Figure 2.24, Valve Train Dynamics Specs Menu

Intake Valve Train Specs

Valve Train Type

This combo box determines what components are present in the valve train. Your choice here can disable some specs in this menu or change their names.

Eff Valve Mass, gms

Describes the mass or weight of the valve train components on the valve side of the rocker arm in grams. This is a portion of the total mass which the cam lobe must open and the valve spring must close. This mass can be calculated by weighing the valve train components and clicking on the Clc button as explained in Section 2.9.16. (For 4 valve engines, see note on page 49.)

Eff Rckr Arm Stffnss, lb/in

Is the effective rocker arm stiffness measured in pounds per inch. Although the rocker arm seems completely solid, it does possess a certain amount of "springiness". The lower the Eff Rckr Arm Stffnss, the "springier" the valve train. This "springiness" can cause valve toss problems at high RPM. Use Table 2.13 to estimate Eff Rckr Arm Stffnss,lb/in. (For 4 valve engines, see note on page 49.)

Table 2.13 Examples of Effective Rocker Arm Stiffness

Description of Valve Train	Eff Rckr Arm Stffnss, lb/in
Pushrod with Poor Design Production Stamped Steel Rocker Arm	22,000
Pushrod with Better Design Production Stamped Steel Rocker Arm	26,000
Pushrod with Production Cast Iron Rocker Arm (like small block Chevy)	30,000
Pushrod with Good Aftermarket Rocker Arm (aftermarket may sacrifice stiffness to lower weight)	30,000

Extremely long rocker arms (big block Chevy, Ford Boss 429, etc)	Subtract about 2000 lb/in
Adding Stud Girdles to Pushrod System	Add about 10000 lb/in
OHC Rocker Arm systems	Add about 10000 lb/in to Pushrod systems values. Note: Stamped steel is not generally used in OHC systems

If you selected Direct Acting OHC as the Valve Train Type, this spec is disabled. See Section 2.9.17 on how to calculate Eff Rckr Arm Stffns from a special test.

Eff Lifter Mass, gms Rocker Arm Mass, gms

Describes the mass or weight of the valve train components on the lifter side of the rocker arm in grams. This mass can be calculated by weighing the valve train components and clicking on Clc as explained in Section 2.9.18.

If you selected one of the Valve Train Designs with rocker arms but no lifter, this spec is called Rocker Arm Mass. Then enter the mass of the rocker arm alone, without the mounting shaft, fulcrum, etc. (For 4 valve engines, see note on page 49.)

Eff Lifter Stiffness, lb/in

Is the effective stiffness of the lifter and pushrod in units of pounds per inch of deflection. Both these components are quite stiff and we recommend using 100,000 lbs per inch. We will provide better estimates as we obtain more data and experience. **In this version of the program, this spec can not be changed and is marked *Program will guess*. This is to make the program easier for most users.** This specs may again be made available if there is enough interest.

This input may be important to your analysis if you are doing detailed valve train dynamics analysis, (strained gauged push rods, "Spintron" testing, etc). In those cases, you may want or need to reduce Eff Lifter Stiffness, especially for hydraulic lifters.

Spring Rate, lb/in (C)

Describes the stiffness of the valve spring in pounds of force required to compress the spring 1 inch. This can be calculated by the following equation:

$$\text{Spring Rate, lb/in} = \frac{\text{change in spring force, pounds}}{\text{change in spring length, inches}}$$

For example, one cam grinder's catalog gives a force at the "checking height" of 1.65" of 110 lbs, and a force at the "open height" of 1.15 inches of 290 lbs. This would give:

$$\text{Spring Rate, lb/in} = \frac{290 - 110}{1.65 - 1.10} = \frac{180}{.55} = 327 \text{ lb/in}$$

See Section 2.9.19 for calculating spring rate by clicking on the Clc button. (For 4 valve engines, see note on page 49.)

Seated Spring Force, lbs

Is the force in pounds exerted by the valve spring on the valve when the valve is closed. See Section 2.9.19 for calculating seated spring force by clicking on the Clc button. (For 4 valve engines, see note on page 49.)

Exhaust Valve Train Specs

Valve Train Type

Eff Valve Mass, gms

Eff Rckr Arm Stffnss, lb/in

Eff Lifter Mass or Rocker Arm Mass

Eff Lifter Stiffness, lb/in

Spring Rate, lb/in

Seated Spring Force, lbs

These exhaust Valve Train Dynamics Specs are used in the same manner as the intake parameters described in this section.

Notes for 4 Valve Engines

The program is primarily set up assuming you are working with 2 valve engines. There are 2 basic ways to use the Valve Train Dynamics portion for 4 valve engines:

Method 1: Characterize the Intake or Exhaust Valves as 1 Valve

For this method, you would enter (or calculate) the effective weight of 1 valve and 1 lifter (follower) and obtain the rocker arm stiffness of 1 rocker arm. You would enter (or calculate) the spring rates of just 1 of the valve springs.

Method 2: Characterize the Intake or Exhaust Valves as 2 Valves

For this method, you would enter (or calculate) the effective weight of both valves and both lifters (followers) and obtain the rocker arm stiffness of both rocker arms together. You would enter (or calculate) the spring rates of both valve springs together. This method (# 2) is more accurate, primarily because the program estimating the cylinder pressure against the valve face for 2 valves (very important on the exhaust side).

Obviously for 3 intake or exhaust valves, you would factor the weights, stiffnesses and spring rates up by a factor of 3 instead of just a factor of 2.

2.7 Turbo/Supercharger Specs

If you click on the Turbo/Supercharger Specs button, you are presented with the 4 choices shown to the right. Select the type of supercharger system, then click on the View Specs button to open the appropriate menu. These menus and their specs are described in this section.

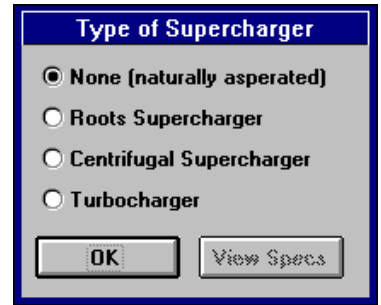

Turbocharger and Supercharger Specs have been expanded in later versions with new inputs. See Appendices 9 - 13 on pages 235-312 for more updated info.

None

Choose None to indicate the engine is not equipped with any type of supercharger or turbocharger. All specs in these menu are then ignored in the calculations.

Roots Supercharger Specs

Note: V3.9 B added 4 new "Modern" types of Roots Superchargers, which are much more efficient. Check Appendix 12, page 277 for more details.

Choose Roots Supercharger if the engine is equipped with a belt driven, positive displacement "Roots" supercharger, like those produced by B&M (tm), Weiand (tm) or the "original" GMC 6-71. A "Roots" compressor looks more like a typical engine oil pump, where a volume of gas is trapped and then forced into the intake manifold. The advantages of an ideal "Roots" supercharger is that a relatively constant boost level can be maintained from low RPM to high RPM.

However, the disadvantages of the "Roots" supercharger include:

- Higher internal friction due to large seals rubbing on surfaces
- Internal leakage reduces boost at lower RPM
- Lower thermal efficiency than a centrifugal supercharger

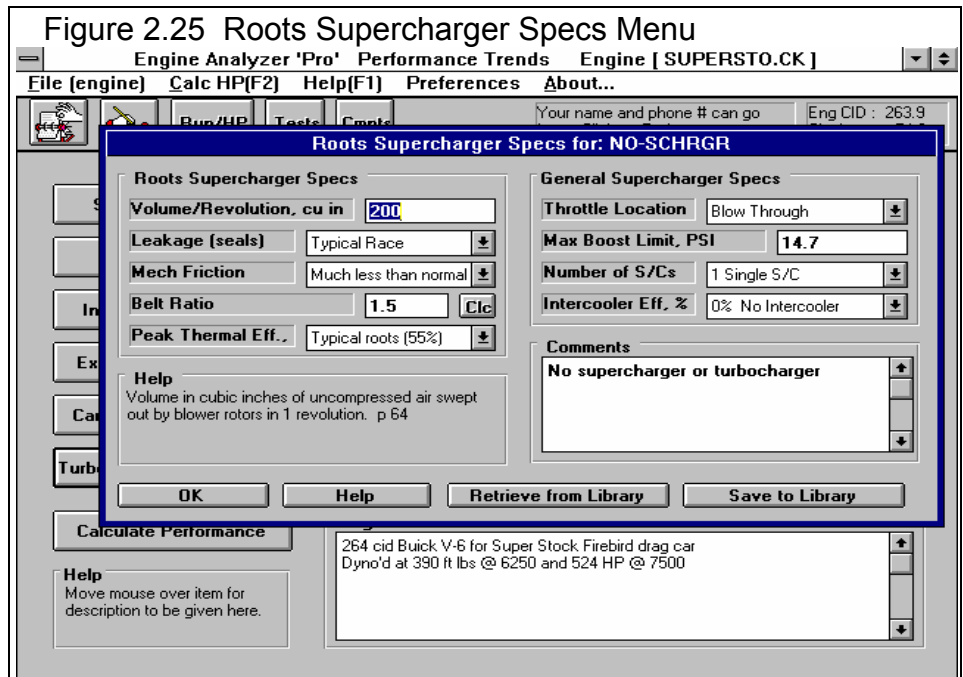

Volume/Revolution, cu in

A "Roots" blower develops boost when the mass of air it pumps to the engine is greater than the mass of air the engine could accept at zero boost. In order for the engine to accept this mass of air it must be compressed, so a given mass of air occupies less volume. Therefore, a "Roots" supercharger boost level is directly related to the mass of air it can pump. This mass of air depends on supercharger RPM (engine RPM and belt ratio) and supercharger swept volume per revolution. The Volume/Revolution spec is critical and is generally available from the supercharger manufacturer.

The Volume/Revolution for GMC blowers can be calculated from the following equations:

For Small Diameter (5.5") Rotors Volume/Revolution, cu in = rotor length, inches x 22.64

For Large Diameter (5.8") Rotors Volume/Revolution, cu in = rotor length, inches x 27.45

For example, for a 6-71 with 5.8" diameter by 15" long rotors:

$$\text{Volume/Revolution, cu in} = 15" \times 27.45 = 412$$

Leakage (seals)

Roots superchargers must trap a volume of air and "shove" it into the engine's intake. However, this trapped air can leak out along several feet of sealing edges. At low speed, this trapped air has a lot of time to leak out which reduces boost. At very low speed (10 RPM), a Roots supercharger will produce no boost since all the air will eventually leak out. At high speed, less time is available for portions of each "chunk" of air to leak out. Therefore, the percent of air leaking out will decrease and boost will increase at higher speed.

Various Leakage ratings can be picked by clicking on the arrow button of the combo box. The more "leaky" the Leakage rating, the lower the boost level, especially at low RPM. However, the advantage to leaky seals is there is less internal friction in the supercharger. This is not significant at full throttle power levels, but is significant in street driving situations. Leaky seals therefore give much better street fuel economy.

The Pro simulates both the change in boost levels and frictional drag depending on your choice of Leakage rating.

Mech Friction

Identifies any change in rubbing friction compared to a typical Roots supercharger with the Leakage rating chosen.

Belt Ratio

Is the ratio between the drive pulley mounted on the engine crankshaft and the driven pulley on the Roots supercharger. This ratio identifies the amount of difference between engine RPM and supercharger RPM. Belt Ratio can be calculated by the equation below or by clicking on the Clc button as shown in Section 2.9.20.

$$\text{Belt Ratio} = \frac{\text{Crank Pulley Diameter, inches}}{\text{S/C Pulley Diameter, inches}}$$

Many people talk about the % overdrive or underdrive of a supercharger. The equation to convert Belt Ratio to % overdrive is:

$$\% \text{ Overdrive} = (\text{Belt Ratio} - 1) \times 100\%$$

For example, if the Belt Ratio is 1.5, the % Overdrive would be $(1.5-1) \times 100\%$ or 50% Overdrive. If the Belt Ratio is .8 the % Overdrive would be $(.8-1) \times 100\%$ or -20% Overdrive or 20% Underdrive.

Safety Note: *You must follow the supercharger manufacturer's recommendations for maximum belt ratios, maximum engine RPM and maximum supercharger RPM.*

Peak Thermal Eff.

Is the peak thermal efficiency of the Roots compressor. Roots compressors do not have as high a thermal efficiency as centrifugal compressors. That is because the a Roots supercharger simply pumps air against a restriction (the engine) to compress it. In centrifugal compressors and special designs of positive displacement superchargers, the air is gradually compressed and gently delivered to the engine. Continual, gentle compression is more efficient.

A good estimate for Peak Thermal Eff. for a typical Roots S/C is 50-55%. The highest likely efficiency for an actual Roots supercharger is 60%, and the lowest could be 40%. For special designs of positive displacement superchargers (Lysolm, Whipple (tm), PSI (tm), "screw type", or rotating vane) which perform gradual compression, add 5 to 10% Peak Thermal Eff., % . Other very high efficiencies are available for you to pick from to see how much efficiency effects performance.

General Supercharger Specs

Throttle Location

This combo box lets you pick where the throttle body or carburetor is placed with respect to the compressor. If the carb or throttle body is before the compressor, pick Draw Through. If the carb or throttle body is after the compressor, pick Blow Through. The carb or throttle body is less restrictive in the Blow Through position. Throttle Location can have a significant effect on carburetor jet size requirements.

Note: Blow Through is almost never used with Roots Superchargers.

Max Boost Limit, PSI

If supercharger conditions are such that it delivers boost greater than this specified level, the Engine Analyzer Pro assumes a mechanical safety valve is activated to limit boost. For Roots superchargers, it assumes a pop off valve "bleeds off" excess boost after the supercharger. Belt ratio is usually used to limit boost with Roots Superchargers, not a mechanical boost limit like a pop off valve. ***Therefore, for most Roots Superchargers, enter a very high limit (which is essentially the same as no limit) like 100 PSI.***

Number of S/Cs

Is the number of superchargers installed. If you specify 1, the program assumes a super/charger system exactly as specified in this menu. If you specify Number of S/Cs as 2 and a Volume/Revolution of 140 cu in, the program assumes the supercharger can actually deliver 280 cu in/rev.

Note: The program assumes 2 superchargers are installed in parallel. This means that half the air flow goes through each supercharger.

Intercooler Eff, %

This combo box lets you pick the effectiveness of the intercooler to cool the intake charge. An intercooler looks much like a radiator, but instead of cooling engine coolant, it cools the intake air charge. A supercharger heats up the intake air considerably through the process of compression. Cool air is more dense than warm air. More cool air can be packed into a given cylinder volume, producing more power. The intercooler allows ambient air (non-compressed, surrounding air) to cool the charge. If the intercooler is 100% effective, the intake charge would be brought down to its original (ambient) temperature as specified by Air Temp in the Weather Conditions in the Calculation Conditions menu with no change in boost pressure.

Table 2.14 Descriptions of Intercooler Effectiveness

Intercooler System	Description
0% No Intercooler	No cooling of the intake charge takes place, that no intercooler is installed.
25% Steady Runng Air-to-Air	The intake charge is brought back 25 % to its original temperature. This level simulates a typical air-to-air intercooler which has been running continually at full boost for over 30 seconds or more. An intercooler's effectiveness tends to drop under sustained full boost operation as the intercooler tends to heat up.
50% Quick Accel Air-to-Air	The intake charge is brought back 50 % to its original temperature. This level simulates a typical air-to-air intercooler for a short "burst" to full boost from a light load condition. The intercooler will not be as hot and can cool the incoming air better until the intercooler heats up.
75% Air-to-Water	The intake charge is brought back 75 % to its original temperature. This level simulates a special intercooler which has a volume of water around the fins. This intercooler is more effective because the water probably starts cooler than an air-to-air intercooler and the water takes longer to heat up (has more "thermal inertia") than just an air cooled intercooler by itself.
100% Air-to-Cold Water	The intake charge is brought back completely (100%) to its original temperature. This level simulates a special intercooler which has a volume of cool water around the fins. This intercooler is more effective because the water starts much cooler than an air-to-air intercooler and the water takes longer to heat up than just an air cooled intercooler by itself.
125% Air-to-Ice Water	The intake charge is cooled to even colder than its original temperature. This level simulates a special intercooler which has a volume of cold water and ice around the fins. This intercooler is more effective because the water probably starts much colder than the surrounding air and takes very long to heat up.
Other	Other types of intercoolers are possible which use freon, or water or alcohol sprays, or cooling fans to keep the intercooler very cold. You will have to estimate how well these work and select from one of the 5 choices available.

Centrifugal Supercharger

Pick the Centrifugal Supercharger option if the engine is equipped with a belt driven, centrifugal supercharger like a Paxton (tm) or Vortech (tm). A centrifugal blower or compressor looks much like a typical engine water pump. The impeller must be driven at very high speeds to create significant boost. Usually, there is a "speed increasing drive system" internal to the centrifugal compressor so the impeller is spinning much faster than its external drive pulley.

In general terms, the boost of a centrifugal superchargers is directly related to the square of the RPM. This means that if it will produce 3 PSI boost at 3000 RPM, it will produce 4 times that boost at twice that RPM (12 PSI at 6000 RPM). Therefore, centrifugal supercharges can be quite "peaky", producing high boost over a narrow RPM range. In addition, since high boost conditions at low speeds are unlikely, engines with centrifugal compressors are less prone to detonation (spark knock).

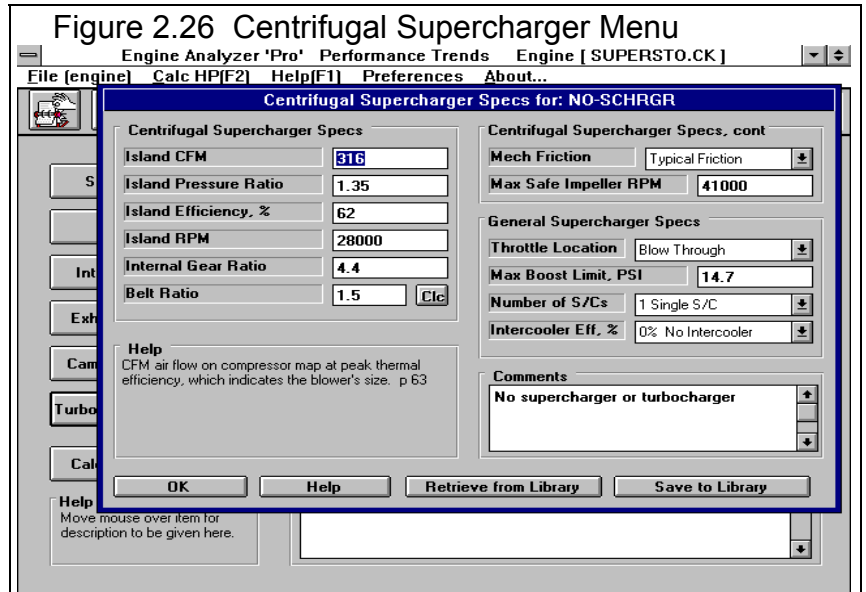

Centrifugal Supercharger Specs have been expanded in later versions with new inputs. See Appendices 9 - 13 on pages 235-312 for more updated info. Enterprise Edition adds even more details. See Appendix 13.

Centrifugal Specs

Centrifugal superchargers are basically a "belt driven" turbocharger. A centrifugal compressor looks like, performs like, and is tested much like a turbocharger compressor. The performance of a centrifugal compressor is also documented in a "map" like that shown in Figure 2.28. Therefore we will characterize the centrifugal supercharger with specs much like we use for a turbocharger.

Centrifugal supercharger specs like those in this section are difficult for the average person to obtain. The supercharger manufacturer may supply maps on request. However, if you do not have specs, we recommend you use the specs which come preloaded in the Centrifugal Supercharger Library for common superchargers.

This section refers to many items discussed in detail in the Turbocharger section which follows. You may want to glance at it first before you read this section.

Island CFM

This spec is much like the turbocharger Island CFM. The centrifugal compressor's Island CFM is the CFM at which the peak efficiency occurs on the "map". For a typical street Paxton (tm) supercharger, this is approximately 320 CFM. For larger superchargers like some Vortechs, this CFM will be from 500-900 CFM.

Island Pressure Ratio

Is the pressure ratio (PR) where peak efficiency occurs just like for turbochargers. PR is usually the vertical "Y" scale and in the range from 1.25 to 2.0 with a street Paxton (tm) being approximately 1.35 and different Vortechs being from 1.5 to 1.8.

Island Efficiency, %

Is the highest thermal efficiency on the compressor map in percent, just like for turbochargers. The highest efficiency will occur in the center of the island. Typical values range from 55 to 70% with a street Paxton (tm) being 62% and many Vortechs being from 70-76%.

Island RPM

Is the compressor RPM where peak efficiency occurs. RPM lines are usually drawn on the compressor "map" as shown in Figure 2.28. Typical values range from 25000 to 50000 RPM, with a Paxton (tm) being approximately 28000 RPM and various Vortechs being from 33000 to 40000 RPM.

Internal Gear Ratio

Centrifugal compressors must spin at relatively high RPM to produce significant boost. Therefore, most compressors have some sort of "speed up" system so the rotor spins much faster than the compressor's external pulley. Ratios of 4.4 and 3.45 are common for a Paxton or Vortech, respectively.

Belt Ratio

Is the ratio between the drive pulley mounted on the engine crankshaft and the driven pulley on the Centrifugal supercharger. This ratio identifies the amount of speed increase between engine RPM and supercharger RPM. Belt Ratio can be calculated by the equation below or by clicking on the Clc button as shown in Section 2.9.20.

$$\text{Belt Ratio} = \frac{\text{Crank Pulley Diameter, inches}}{\text{S/C Pulley Diameter, inches}}$$

Many people talk about the % overdrive or underdrive of a supercharger. The equation to convert Ratio to % overdrive is:

$$\% \text{ Overdrive} = (\text{Belt Ratio} - 1) \times 100\%$$

For example, if the Belt Ratio is 1.5, the % Overdrive would be $(1.5-1) \times 100\%$ or 50% Overdrive. If the Belt Ratio is .8 the % Overdrive would be $(.8-1) \times 100\%$ or -20% Overdrive or 20% Underdrive.

Safety Note: You must follow the supercharger manufacturer's recommendations for maximum belt ratios, maximum engine RPM and maximum supercharger RPM.

Mech. Friction

This combo box lets you pick a general friction rating for the supercharger.

Max Safe Impeller RPM

This is the manufacturer's safety limit on impeller RPM. The program checks to ensure the belt ratio and engine RPM combination stays below this RPM, or you are given a warning in the Notes section of the Test results.

Safety Note: *You must follow the supercharger manufacturer's recommendations for maximum belt ratios, maximum engine RPM and maximum supercharger RPM.*

General Supercharger Specs

Throttle Location

This combo box lets you pick where the throttle body or carburetor is placed with respect to the compressor. If the carb or throttle body is before the compressor, pick Draw Through. If the carb or throttle body is after the compressor, pick Blow Through. The carb or throttle body is less restrictive in the Blow Through position. Throttle Location can have a significant effect on carburetor jet size requirements.

Note: Centrifugal superchargers use both Blow Through and Draw Through setups.

Max Boost Limit, PSI

If supercharger conditions are such that it delivers boost greater than this specified level, the Engine Analyzer Pro assumes a mechanical safety valve is activated to limit boost. For Centrifugal superchargers, it assumes a pop off valve "bleeds off" excess boost after the supercharger. Belt ratio is usually used to limit boost with Centrifugal Superchargers, not a mechanical boost limit like a pop off valve. **Therefore, for most Centrifugal Superchargers, enter a very high limit (which is essentially the same as no limit) like 100 PSI.**

Number of S/Cs

Is the number of superchargers installed. If you specify 1, the program assumes a supercharger system exactly as specified in this menu. If you specify Number of S/Cs as 2 and Island CFM of 300, the program assumes the supercharger can actually deliver 600 CFM.

Note: The program assumes 2 superchargers are installed in parallel. This means that half the air flow goes through each supercharger.

Intercooler Eff, %

This combo box lets you pick the effectiveness of the intercooler to cool the intake charge. An intercooler looks much like a radiator, but instead of cooling engine coolant, it cools the intake air charge. A supercharger heats up the intake air considerably through the process of compression. Cool air is more dense than warm air. More cool air can be packed into a given cylinder volume, producing more power. The intercooler allows ambient air (non-compressed, surrounding air) to cool the charge. If the intercooler is 100% effective, the intake charge would be brought down to its original (ambient) temperature as specified by Air Temp in the Weather Conditions in the Calculation Conditions menu with no change in boost pressure. See Table 2.14 in the Roots Supercharger section for definitions of the various ratings.

Turbocharger

Select Turbocharger if the engine is equipped with a turbocharger which most engine builders are familiar with. A turbocharger is basically a centrifugal compressor tied to a turbine which is driven by engine exhaust gases.

Turbocharger Specs have been expanded in later versions with new inputs. See Appendices 9 - 13 on pages 235-312 for more updated info. Enterprise Edition adds even more details. See Appendix 13.

1st Stage Turbocharger Specs

These specs describe the size and efficiency of the turbocharger's compressor and exhaust driven turbine. The *1st Stage* reference means this is the first turbocharger the incoming air is compressed by. On single stage systems, these are the specs to simulate the only staging of turbocharger.

The size and performance of the turbocharger's compressor can be obtained from a compressor "map", which are available from the manufacturer. A typical compressor map is shown in Figure 2.28. The "island" is the area which gives the maximum efficiency, and is where you want your turbo compressor to operate. The Engine Analyzer Pro will need information about the point where the peak efficiency occurs.

The turbocharger compressor and turbine sizes determine how soon or at what RPM the turbo will start developing boost. Compressor and turbine sizes are primarily dictated by Island CFM and Turbine Nzzl Dia respectively. A small turbo system will develop boost at a lower RPM, but will become restrictive at higher RPM and higher air flows. Therefore, small turbos are better choices for street use. Larger turbos are better suited to race engines where RPM is continually high, and flow restrictions must be kept to a minimum.

Island CFM

Is the CFM where peak efficiency occurs. CFM is usually the horizontal "X" scale of a compressor map. If the air flow is given in pounds per minute, click on Calc to calculate CFM as explained in Section 2.9.21.

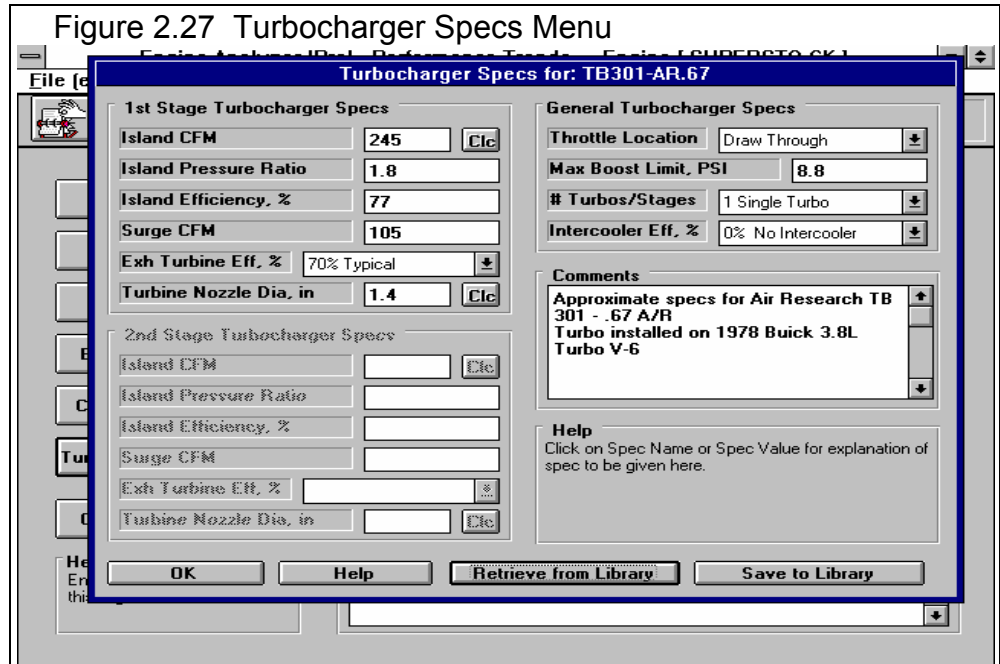
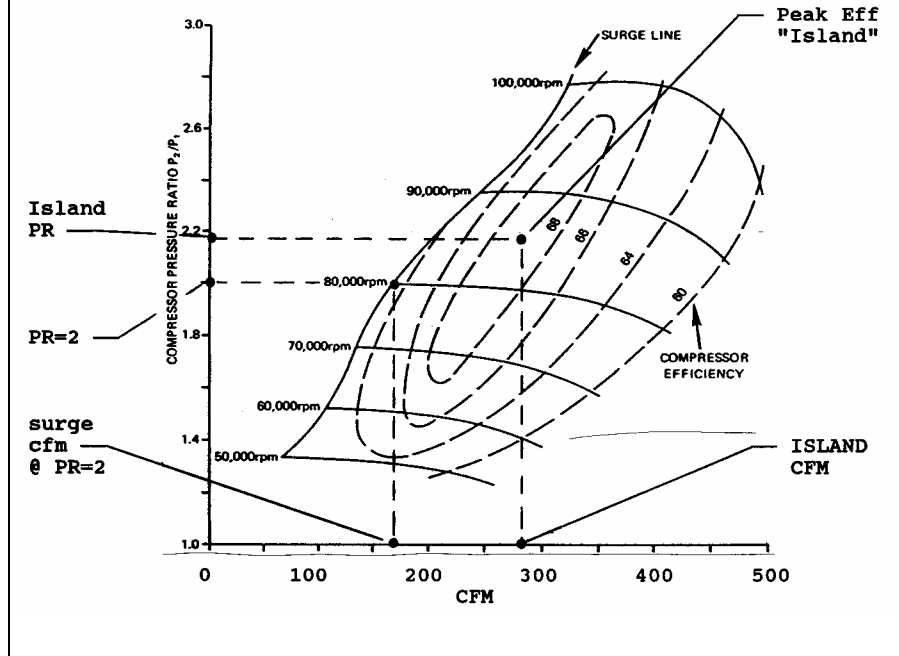

Figure 2.28, Definitions of Turbocharger Specs from Typical Compressor Performance Map



If you do not have a compressor map, estimate Island CFM from your engine's displacement and application as in Table 2.15 or pick one from the Turbocharger Library.

Table 2.15 Estimate Island CFM

Engine CID	Application	Island CFM	Number of S/Cs
less than 50	Street	60	1
less than 50	Race	100	1
50 - 100	Street	150	1
50 - 100	Race	225	1
100 - 150	Street	200	1
100 - 150	Race	300	1
150 - 250	Street	250	1
150 - 250	Race	400	1
250 - 400	Street	450	1
250 - 400	Race	350	2
400 - 600	Street	350	2
400 - 600	Race	500	2

Island Pressure Ratio

Is the pressure ratio (PR) where peak efficiency occurs. PR is usually the vertical "Y" scale of a compressor map and is usually in the range from 1.5 to 2.5.

If you do not have a compressor map, use a PR of 1.8 or pick one from the Turbocharger Library.

Island Eff, %

Is the highest thermal efficiency on the compressor map in percent. The highest efficiency will occur in the center of the island. Typical values range from 65 to 80%.

If you do not have a compressor map, use 70% for Island Eff or pick one from the Turbocharger Library.

Surge CFM

"Surge" is a phenomena in turbos characterized by unstable, potentially destructive operation. Surge occurs at high pressure ratios with low air flow. The surge line defines the point at which surge will start to occur. To tell the program where the surge line is, locate a PR of 2 on the vertical axis. Move straight across to the surge line, and then drop straight down to the horizontal air flow axis. This air flow is the surge CFM @ PR=2 and defines the surge line to the program. Also see Figure 2.28.

If your map is given in lb/hr, click on the Clc button Island CFM to obtain the surge CFM @ PR=2. If you do not have a compressor map, use 3/4 of the CFM entered for Island CFM or pick one from the Turbocharger Library.

Exh Turbine Eff, %

Is the exhaust driven turbine's average thermal efficiency. Seventy percent (70%) is a good estimate for a typical turbo turbine. For normal turbine designs, 80% is probably the highest possible efficiency. This can be obtained with a "pulse" turbo which is designed to more efficiently capture the pressure *and velocity* of the exhaust gasses. A poor turbo design would have an efficiency of approximately 55%.

Turbine Nozzle Dia, In

Is the exhaust turbine's minimum flow area's diameter in inches. This parameter determines when the compressor will start to produce boost, the smaller the diameter, the earlier the boost. This parameter allows you to simulate different turbine housings with various A/R ratios.

Most radial flow turbines have no vanes, and the flow area is the minimum area in the nozzle section as exhaust first enters the turbine. See Figure 2.29. Click on the Clc button to calculate the Turbine Nozzle Dia from turbine dimensions or from the Island CFM of the compressor as explained in Section 2.9.22.

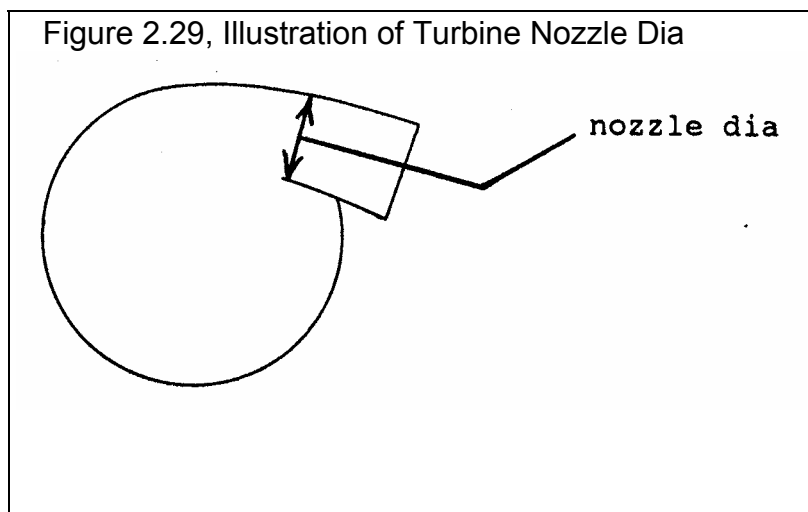

Safety Note: Although the Engine Analyzer Pro can do a very realistic job of estimating turbocharger performance, **DO NOT** rely on it alone to safely choose the optimum turbocharger size for a specific engine. Turbochargers can overspeed (potentially explode from overrevving) or create excessive exhaust temperatures and pressures if sized incorrectly. Use the Engine Analyzer Pro only for estimating potential performance gains with various approximate turbocharger sizes. You must follow the turbo manufacturer's recommendations for safe turbo combinations for your application.

An expanded Calculation Screen was added in v3.9 to allow you to better estimate this critical input. See Appendix 11 starting on page 261.

2nd Stage Turbocharger Specs

The 2nd stage turbocharger specs have not yet been activated in this version of the program.

General Turbocharger Specs

Throttle Location

This combo box lets you pick where the throttle body or carburetor is placed with respect to the compressor. If the carb or throttle body is before the compressor, pick Draw Through. If the carb or throttle body is after the compressor, pick Blow Through. The carb or throttle body is less restrictive in the Blow Through position. Throttle Location can have a significant effect on carburetor jet size requirements.

Note: Both Blow Through and Draw Through setups are common with turbochargers.

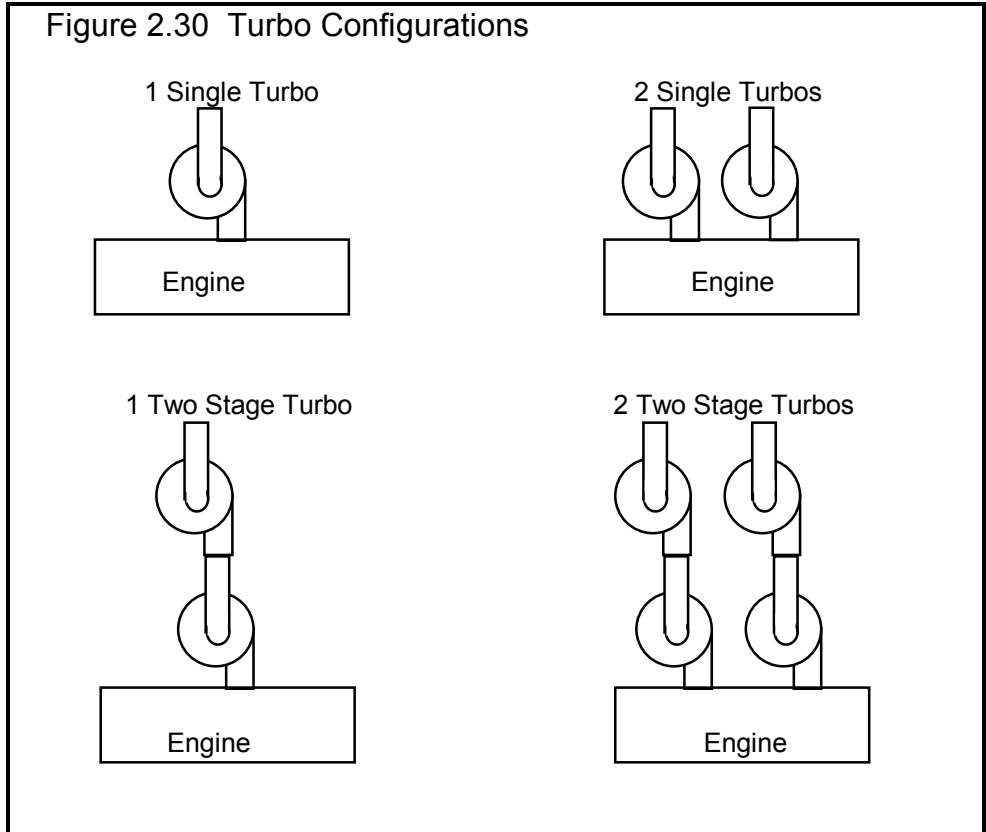

Max Boost Limit, PSI

If turbocharger conditions are such that it delivers boost greater than this specified level, the Engine Analyzer Pro assumes an exhaust bypass valve or wastegate is activated to limit boost. Wastegates divert exhaust gasses around the turbocharger's turbine. This is a very common way to control boost, especially for street applications. Therefore, set Max Boost Limit to the pressure the wastegate is designed to control boost to.

Turbos/Stages

Is the number of turbochargers installed and if there is one or 2 stages of turbos. This combo box lets you pick one of the 4 combinations shown in Figure 2.30. Note that 2 stage turbocharging has not yet been activated at the printing of this manual.

Intercooler Eff, %

This combo box lets you pick the effectiveness of the intercooler to cool the intake charge. An intercooler looks much like a radiator, but instead of cooling engine coolant, it cools the intake air charge. A turbocharger heats up the intake air considerably through the process of compression. Cool air is more dense than warm air. More cool air can be packed into a given cylinder volume, producing more power. The intercooler allows ambient air (non-compressed, surrounding air) to cool the charge. If the intercooler is 100% effective, the intake charge would be brought down to its original (ambient) temperature as specified by Air Temp in the Weather Conditions in the Calculation Conditions menu with no change in boost pressure. See Table 2.14 in the Roots Supercharger section for definitions of the various ratings.

2.8 Calculate Performance

2.8.1 Calculation Conditions

You can run a test (calculate performance) by:

- Clicking on the Run/HP button at the top of the Main Menu
- Pressing <F2> at the Main Menu
- Clicking on Calc HP(F2) menu item in the menu bar at the top of the Main Menu
- Clicking on Calculate Performance to open up the Calculate Performance Conditions menu, then click on the Calculate Performance button in this menu. The Calculate Performance Conditions menu will present a menu of conditions and options which describe how you will run or test this engine. These conditions include:
 - Environmental conditions
 - Level of nitrous oxide, type of fuel and spark advance
 - RPMs to run, and options for the calculations
 - Whether or not to "chain" calculations together (make several test runs at once)

Calculate Performance Conditions have been expanded in later versions with new inputs. A new Preference in v3.9 allows for Metric outputs. See Appendices 9 - 13 on pages 235-312 for more updated info.

Test Conditions

Barometric Pressure, "Hg

Is the barometric pressure in inches of mercury of the nearest weather station; or at the track or dynamometer room if a barometer instrument is available at these locations.

If this pressure is in:	Multiply by:
PSI	2.036
Bar	29.52
mm Hg	.03937
To obtain " Hg. For example: 14 PSI is 14 x 2.036 or 28.5" Hg.	

Click on the Clc button to review notes concerning the relationship of Barometric Pressure and Elevation. Also see Elevation, ft and Section 2.9.23.

Intake Air Temp, deg F

Is the temperature of the intake air as it enters the carburetor or throttle body measured in degrees Fahrenheit. To match dynamometer performance, enter dynamometer room air temperature. To simulate vehicle performance, enter the temperature of the air entering the air cleaner. Underhood temperatures can be HOT on warm days (150 degrees or more). If a hood scoop

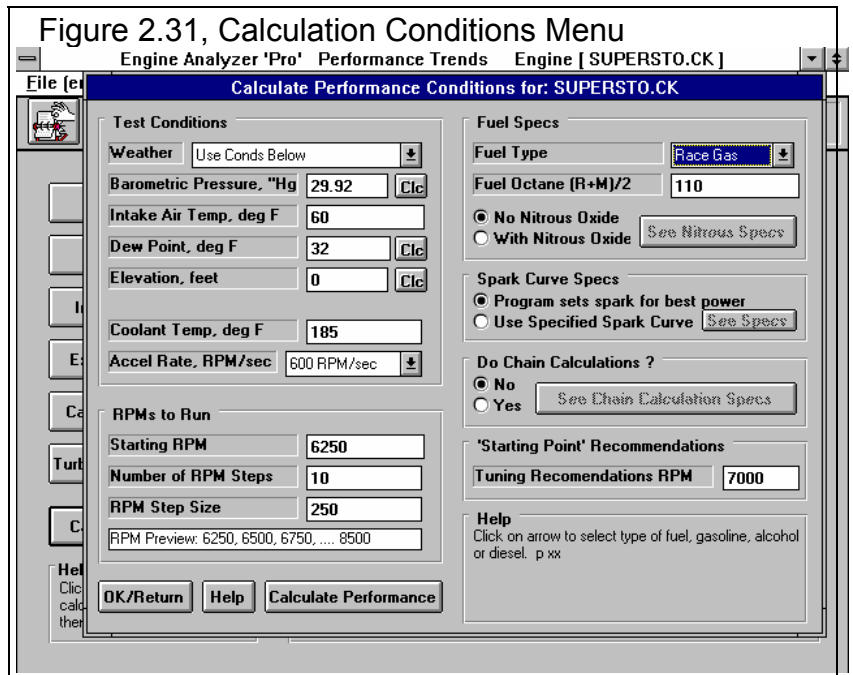

or some other type of cool air induction is provided, outside (ambient) air temperature is closer to the actual intake air temperature.

If this temperature is in:	First Multiply by:	Then Add:
Degrees R	1	- 460
Degrees C	1.8	32
Degrees K	1.8	- 460

To obtain degrees F. For example 30 deg C = $30 \times 1.8 + 32 = 86$ degrees F.

Version 3.9 has a Preference which allows you to select outputs to be displayed in Metric units. See Appendix 11, page 261.

Dew Point, Deg F

The dew point in degrees F of the air at the track, which describes the air's humidity level. The Dew Point must be less than Intake Air Temp, deg F. Dew Point can be calculated from either wet and dry bulb temperatures, or from relative humidity and air temperature readings by clicking on the Clc button. See Section 2.9.24.

Dew Point is a less confusing way of describing the air's moisture level than relative humidity. Relative humidity readings are only meaningful if you also know the air temperature when the reading was made. However, the air's dew point remains constant even when the air temperature changes. For example, 40 degree air with a 80 % relative humidity has only a 10% relative humidity when the air is heated to 100 degrees. However, the dew point remains at 36 degrees for both air temperatures.

Elevation, ft

Is the elevation of the race track or dynamometer room above sea level measured in feet. This value should be available from the local weather station and is used to correct the Barometric Pressure, "Hg specification. Barometric pressure drops as you go up in elevation. There are two different ways of entering this specification, depending on how the Barometric Pressure measurement was made:

Barometric Pressure obtained from radio station, TV station or weather service: "Official sources" usually correct their barometric pressure readings to sea level, meaning their reading is the barometric pressure you would get if you (or your engine) could be at sea level or 0 elevation. ***If you have a Barometric Pressure corrected to sea level, you must enter the engine's actual elevation above sea level in feet.***

Barometric Pressure obtained directly from a barometer instrument at the track or dynamometer room. This reading will usually not be corrected to sea level, but will be the "observed" or actual barometric pressure reading at the same elevation as the engine. ***For observed or uncorrected Barometric Pressure, enter an elevation of 0.***

Click on the Clc button to review notes concerning the relationship of Barometric Pressure and Elevation. Also see Barometric Pressure in this section and Section 2.9.23.

Coolant Temp, deg F

Is the temperature of the coolant as it leaves the engine in degrees Fahrenheit. This value can be estimated as the "start to open" temperature rating of the thermostat. If the engine is air cooled, enter a value of 190 degrees.

Accel Rate, RPM/Sec

For race engines, many dynamometer tests are conducted with the engine accelerating from low speed to high speed at a particular rate. Common rates include 300 and 600 RPM/sec. Under accelerating conditions, power is absorbed in the engine's and dyno's rotating inertia, and usable power at the engine's flywheel is reduced. The faster the Accel Rate and the higher the Total Inertia set in the Short Block specs, the more power lost to rotating inertia. See the $Lb \times Ft^2$ spec under Engine Inertia / Crank Design in Section 2.2.

Dynamometer tests for production engines are usually done at "steady state" or "steps", with the dyno holding speed constant while torque is measured at each RPM. To simulate "steady state" tests, enter 0 for Accel Rate, RPM/Sec. Then the Total Inertia in the Short Block specs is ignored, and no power is lost to accelerating inertia during the test.

Notes:

The Engine Analyzer Pro only calculates power lost to accelerating the rotating inertia. Other acceleration effects like throttle response, accelerator pump shot, hesitation or bog are not simulated.

Some dynamometer measurement systems correct for these inertia effects, for example Depac (tm). For these systems, pick one of the 0 Accel Rates (Steady State or Step Test) even though the test is done with the engine accelerating.

RPMs to Run

Starting RPM

See RPM Step Size below.

Number of RPM Steps

See RPM Step Size below.

RPM Step Size

These three RPM specifications tell the Engine Analyzer Pro for how many and for which RPMs to calculate the results. The effect of these specs are displayed in the RPM Preview box shown directly under these specs. For example:

Starting RPM	1000
Number of RPM Steps	8
RPM Step Size	400

This combination will have results calculated for the following RPMs:

1000 1400 1800 2200 2600 3000 3400 3800

Due to space limitations, all RPMs can not be shown on the menu. The RPM Preview will show this as:

RPM Preview: 1000, 1400, 1800,3800

Fuel Specs:

Fuel Type

Specifies the type of fuel being burned, either street gasoline, alcohol (methanol) or race gasoline. The Engine Analyzer Pro makes the following assumptions about the difference between these fuels.

- Alcohol is run at 5.0 A/F versus 12.5 for gas. (This is a change from v1.2 which assumed 4.55 A/F.)
- Alcohol is 13% more dense than gas
- Alcohol produces a 12% increase in products of combustion, where gas only produces a 6% increase
- Alcohol produces 4% more heat per unit of air than gas
- Alcohol at 5.0 has the same burn rate as gas at 12.5 and therefore requires the same spark advance. (In actual practice, there is conflicting data concerning alcohol's burn rate or required spark advance. It appears very dependent of A/F mixture quality, A/F distribution, and other factors difficult to simulate. Therefore, this assumption is made.)
- Drag Racing gas has a lower vapor pressure than gasoline (does not want to atomize as easily)
- Drag Racing gas releases slightly more energy than gasoline.
- Both are assumed to run at 12.5 A/F.

Obviously many more considerations must be made when building an alcohol engine than what are considered in the Engine Analyzer Pro. Generally, alcohol has a fuel octane (R+M)/2 of 100. You must change the octane # when you change fuels.

The Fuel Specs have been expanded in later versions. See Appendices 9 - 13 on pages 235-312 for more updated info.

Fuel Octane (R+M)/2

Is the octane # rating of the fuel as reported on a service station gas pump. There are two methods fuel suppliers use to rate the octane number, one is the Research method, the other is the Motor method. Generally, the Motor method will give an octane rating approximately 4-12 octane #s lower than the Research method. The octane rating given at the gas pump is the average of

the Research and the Motor ratings. In fact, gas pumps will often display the formula "(R+M)/2" to say their octane rating is the Research octane # plus the Motor octane # divided by 2.

To estimate Fuel Octane from the Research octane #, simply subtract 4. To estimate Fuel Octane from the Motor octane #, simply add 4. For example, if you know the Motor octane is 94, enter a Fuel Octane (R+M)/2 of 94 + 4 = 98 into the Engine Analyzer Pro .

The Engine Analyzer Pro assumes that as octane increases, vapor pressure decreases. Vapor pressure is a measure of how easily the gas evaporates or can be atomized. What this means is that the higher the octane, the more likely you are to have poor A/F Mxtr Qulty in the results, resulting in possibly significant power loss. This means that for best performance, only use as much octane as you need to eliminate detonation by keeping Knock Index low.

Tuning Recommendations RPM

The Engine Analyzer Pro can give recommendations for intake and exhaust runner dimensions and cam profiles based on several *very simple* tuning principles or *rules of thumb*. See Appendix 3 and Example 4.5. These are good starting points, but you should fine tune these specs based on trial and error with the Pro’s calculations.

Enter the RPM where you want optimum intake and exhaust tuning, or a torque or HP peak. The Engine Analyzer Pro will list potentially good runner lengths and diameters, and cam durations and lifts at the end of the calculated results. This value has no affect on the torque and HP test results.

Nitrous Oxide

- No Nitrous Oxide
- With Nitrous Oxide

Click on the With Nitrous Oxide option and the See Nitrous Specs button becomes enabled. Click on this button to open up the Nitrous Oxide Specs menu shown to the right.

These specs describe the amount of nitrous oxide a system can deliver. Most nitrous systems are rated for the HP increase they can deliver in a properly tuned engine. The Engine Analyzer Pro makes 3 major simplifying assumptions concerning nitrous oxide injection:

- Jet sizes are proper for correct A/F, and good nitrous and fuel distribution
- Nitrous is injected as a liquid and only a portion vaporizes on the way to the cylinder. There is little displacement of the air which would normally enter the engine under "non-nitrous" conditions.
- Nitrous increases the burn rate, reducing the required spark advance.

You can not use the Engine Analyzer Pro to design nitrous systems, but only to estimate performance improvements. Select the No Nitrous Oxide options to simulate an engine without nitrous oxide injection. The specs in the Nitrous Oxide Specs menu are then ignored.

Figure 2.32 Nitrous Oxide Specs Menu

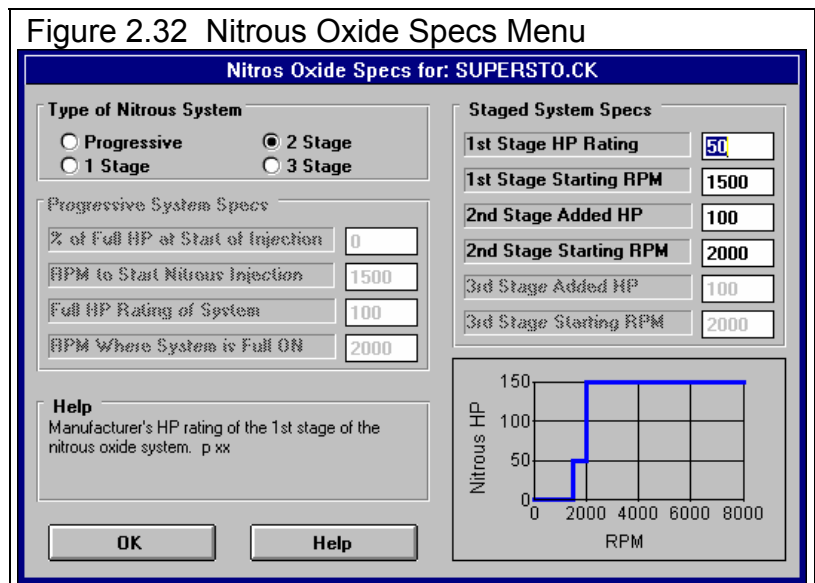

As you change specs in this menu, the Nitrous HP graph is constantly being updated to show how the system specified will deliver nitrous. This graph is the best way to see the effect of various systems, nitrous levels and RPM set points. Also watch the test results Nitrous, lb/hr and Ntrs Fuel, lb/hr to see the amount of nitrous injected.

Type of Nitrous System

Progressive

1 Stage

2 Stage

3 Stage

Select the type which describes the system you are using. Various portions of the Nitrous Oxide Specs menu become enabled and disabled depending on your choice here.

Progressive System Specs

% of Full HP at Start of Injection

This is the amount of nitrous delivered (% of the full system HP rating) when the progressive system first start to inject nitrous.

RPM to Start Nitrous Injection

This is the engine RPM where the progressive system first start to inject nitrous.

Full HP Rating of System

This is the amount of nitrous delivered when the progressive system is delivering its maximum nitrous flow.

RPM Where System is Full On

This is the RPM where the progressive system reaches maximum nitrous flow.

Staged System Specs

1st Stage HP Rating

Manufacturer's HP rating of the 1st stage of the nitrous oxide system. If you are using a 1 stage system, this is the full HP rating of this type of system.

1st Stage Starting RPM

RPM where injection from the 1st stage starts.

2nd Stage Added HP

Manufacturer's HP rating of the nitrous oxide added by the 2nd stage. Total nitrous HP is then 1st Stage HP + 2nd Stage HP.

2nd Stage Starting RPM

RPM where injection from the 2nd stage starts.

3rd Stage Added HP

Manufacturer's HP rating of the nitrous oxide added by the 3rd stage. Total nitrous HP is then 1st Stage HP + 2nd Stage HP + 3rd Stage HP.

3rd Stage Starting RPM

RPM where injection from the 2nd stage starts.

Spark Curve Specs

- Program sets spark for best power
- Use Specified Spark Curve

Click on the Use Specified Spark Curve option and the See Specs button becomes enabled. Click on this button to open up the Specified Spark Curve menu shown to the right.

As you change specs in this menu, the Spark Advance graph is constantly being updated. This graph is the best way to see the effect of changing spark curve specs. Also watch the test results Spark Advance and Knock Index to see the spark advance at various RPMs and the level of detonation. If Knock Index is high, greater than 2, specify lower Spark Advance specs.

Figure 2.33 Spark Curve Specs Menu

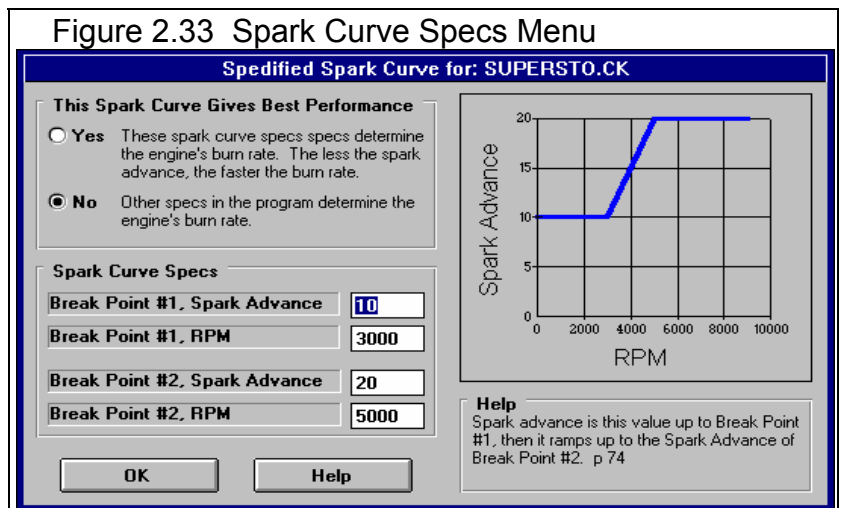

This Spark Curve Gives Best Performance

- Yes These spark curve specs determine the engine's burn rate. The less the spark advance, the faster the burn rate.
- No Other specs in the program determine the engine's burn rate

You choice of these options will have a large impact on engine performance. Their effect can best be explained by the following examples:

Example 1

If at the Calculation Conditions menu you chose the *Program sets spark for best power* option, the menu and specs in this section are *not* available and have no effect on calculated performance.

Calculation Conditions Menu

- Program sets spark for best power
- Use Specified Spark Curve

Assume that for this engine at this RPM the Engine Analyzer Pro determines the flame requires 50 degrees to completely burn the air/fuel charge to give optimum performance. This allows 25 degrees for combustion before TDC, 25 degrees for combustion after TDC. The program will automatically set a Spark Advance timing of 25 degrees BTDC (before top dead center).

Example 2

If at the Calculation Conditions menu you chose the *Use Specified Spark Curve* option, the menu and specs in this section *are* available to change and do effect calculated performance.

Calculation Conditions Menu

- Program sets spark for best power
- Use Specified Spark Curve

This Spark Curve Gives Best Performance

- Yes
- No

Break Point #1, Spark Advance

As in Case 1 the Engine Analyzer Pro determines the flame requires 50 degrees to completely burn the air/fuel charge. The Engine Analyzer Pro will set 15 degrees spark timing as you specify. Combustion will be completed at 35 degrees after TDC (15+35=50). The combustion period is retarded 10 degrees from optimum on 25 degrees BTDC. This should result in a loss of performance, but also reduces the possibility of spark knock (reduce Knock Index and Mx Cyl Pres in the test results).

Example 3

If at the Calculation Conditions menu you chose the *Use Specified Spark Curve* option, the menu and specs in this section *are* available to change and do effect calculated performance.

Calculation Conditions Menu

- Program sets spark for best power
- Use Specified Spark Curve

This Spark Curve Gives Best Performance

- Yes
- No

Break Point #1, Spark Advance

In order for 15 degrees of spark advance to be optimum for performance, the total combustion process must only require 30 degrees, 15 degrees before TDC and 15 degrees after TDC. The Engine Analyzer Pro will set 15 degrees spark timing as you specify and speed up the combustion process so it only requires 30 degrees total. This should result in an improvement in performance, thermal efficiency and fuel economy. However cylinder pressure (Mx Cyl Pres, PSI) is likely to increase so the engine will require stronger parts. (Knock Index could either increase or decrease depending on other factors.)

Break Point #1, Spark Advance

Spark advance is this value up to Break Point #1, then it ramps up to the Spark Advance of Break Point #2.

Break Point #1, RPM

RPM where Break Point #1 occurs (and spark advance starts to ramp up).

Break Point #2, Spark Advance

Spark advance ramps up to this value at Break Point #2 and remains here as RPM increases.

Break Point #2, RPM

RPM where Break Point #2 occurs (where engine reaches maximum spark advance).

The Spark Table Specs have been expanded in later versions with up to 6 levels of Break Points. See Appendices 9 - 13 on pages 235-312 for more updated info.

Chain Calculations

Do Chain Calculations

- No
- Yes

Click on the Yes option and the See Chain Calculation Specs button becomes enabled. Click on this button to open up the Chain Calculation specs menu shown to the right.

The Chain Calculation option allow you to make up to 36 consecutive tests or performance calculations without having to be at the computer to enter commands between tests. Since the Engine Analyzer Pro requires a good deal of execution time on slower computers, this option is a great convenience. Chain calculations are best explained with an example. Let's assume we want to optimize lobe separation and cam timing. This can be done by trying several intake and exhaust lobe centerlines, for example:

```
Intake Lobe Centerline  100, 104,108, 112, 116, 120
Exhaust Lobe Centerline 100, 104,108, 112, 116, 120
```

The settings in Chain Calculation menu of Figure 2.34 are set to do this particular Chain Calculation. You will end up with 36 tests, every possible combination of these settings, when the test is complete.

Important: Because of the large amount of data which can be produced with Chain Calculations, there is a limitation. Only torque and HP data is saved for each calculation. No other RPM data and no cycle data is saved, reported or graphed.

The Chain Calculation Specs have been greatly expanded in later versions. See Appendices 9 - 13 on pages 235-312 for more updated info.

Specs to Chain

- 1
- 2

Select 1 if you want only 1 engine spec to be chained, 2 if you want 2 specs to be changed. In the example above, if you selected 1, the Chain Spec #2 items would have been dimmed. The results would have only consisted of 6 tests of the different Intake Centerlines. The Exhaust Centerline would have stayed at whatever value was currently entered in the Cam/Valve Train Specs menu.

Chain Spec #1

Spec Type and Name

Click on arrow for a list of possible specs for the first chain calculation. Not all engine specs can be chained. Also see Chain Step Size below.

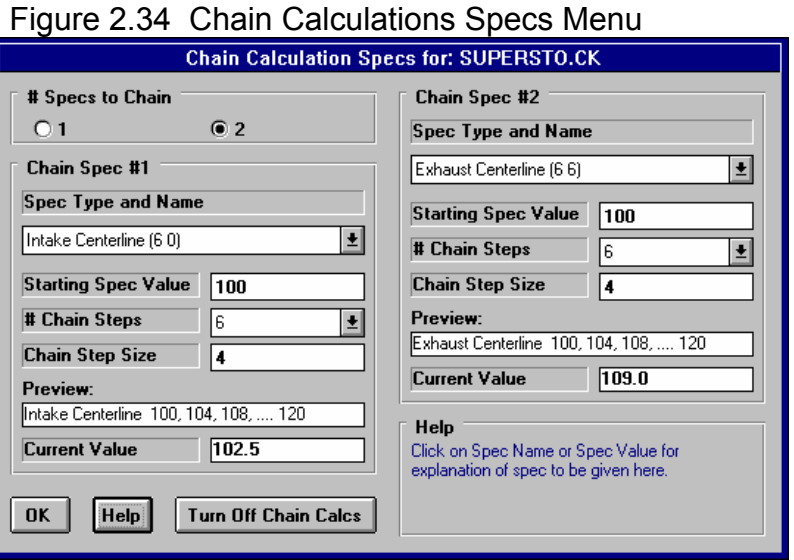

Starting Spec Value

The value of the first chain calculation for Chain Spec #1. Also see Chain Step Size below.

Chain Steps

The number of settings for Chain Calculation #1, 2-6. Also see Chain Step Size below.

Chain Step Size

The amount of increase in Chain Spec #1 between successive chain calculations.

Based on the settings of these specs, the program will show you a preview of the settings which will be tested in the Chain Calculation. If you have chosen an unusual set of specs, say cylinder Bore: 220, 230, 240, ...270 (which is outside the program's limits for bore sizes) the program will warn you when you leave this menu. You must then either correct these specs to make sense or click on Turn Off Chain Calcs.

Current Value

Displays the current setting of the spec you are going to chain, and is simply a handy reminder.

Chain Spec #2

Spec Type and Name

Starting Spec Value

Chain Steps

Chain Step Size

These specs are the same as those described for Chain Spec #1 above. These are not available if you have chosen 1 as the # Specs to Chain.

2.8.2 Test Results from Calculated Performance

The Engine Analyzer Pro’s calculated output consists primarily of 3 types:

- RPM Data. This is data which changes for each RPM tested, like torque, HP, fuel flow, etc.
- Special Calculations. This is data which does *not* change with RPM, like cubic inch displacement, dynamic compression ratio, etc.
- Cycle Data. This is data which changes within an RPM, for each different crank angle of the engine, like piston position, cylinder pressure, etc.

RPM Data and Special Calculations are shown in Figure 2.35. Cycle data is only available for graphing, for display with the See-Engine feature, or for exporting as an ASCII file. Several other features are available from this screen (Figure 2.35) which are also discussed in this section.

A new Preference in v3.9 allows you to select various data types to be displayed in Metric units. See Appendix 11 on page 261 for more updated info.

Figure 2.35 Major Features of Output Screen Showing Test Results

Menu bar with output options: Back to Main Menu, Make Graphs, Print Results, Display Help, Save or Open Files of Test Results, Analyze results (program gives advice based on user requirements and current results), See Engine piston/valves/valve dynamics/air flows, etc.

Command buttons: Make Graphs, Print Results, Display or Edit Engine and Component Comments, Display Notes (safety issues, possible problems, etc.) about current test results

Summary of Notes (safety issues, possible problems, etc.)

Name of current Engine File

Name of current Test File

Performance Summary

RPM Data. Click on any cell if the grid for a Help definition of that particular piece of data.

Slide bar. Click and drag button to display all RPM test results.

Special Calculations. Results which do not change with RPM. Click on any result for a Help definition of that particular piece of data.

Slide bar. Click and drag button to display all Special Calculation test results.

Horizontal slide bar. Click and drag to display all RPM Data if # RPMs is greater than 15.

Engine RPM	1200	1600	2000	2400	2800	3200	3600	4000	4400	4800
Brk Tq, R-lbs	259	268	272	272	273	284	283	278	270	253
Brake HP	59.2	81.6	104	124	145	173	194	212	226	231
Exh Pres, PSI	0.1	0.2	0.4	0.6	0.8	1.2	1.5	1.9	2.2	2.5
Int Vac, "Hg	0.2	0.3	0.6	0.8	1.2	0.5	0.6	0.8	0.9	1.1
Vol Eff, %	71.9	73.0	74.0	75.2	77.2	81.2	82.9	83.8	83.8	82.2
Actual CFM	75.3	102	129	157	189	227	260	293	322	344
Fuel Flow, lb/hr	26.3	35.6	45.1	55.0	65.9	79.2	91.0	102	112	120
Nitrous, lb/hr	0.0	0.0	0.0	0.0	0.0	0.0	0.0	0.0	0.0	0.0
Ntrs Fuel, lb/hr	0.0	0.0	0.0	0.0	0.0	0.0	0.0	0.0	0.0	0.0
BMEP, PSI	130	134	136	136	136	142	142	139	136	126
A/F Mxtr Qty, %	93.4	97.7	100.0	100.0	100.0	99.1	100.0	100.0	100.0	100.0
BSEC, lb/HP-hr	0.444	0.437	0.436	0.443	0.454	0.458	0.469	0.487	0.498	0.521

Valve Flow & Cam Calculations		int	Exh
Overlap Area, deg*sq-in	0.8	162.6	117.8
Total Exh/Int %	72.5	0.249	0.272
Lobe Separation, deg	115.0	19.82	19.82
Overlap, deg	34	262	262
		Opening Events, deg	15
		Closing Events, deg	67
Overlap @.050, deg	-28	Duration @.050, deg	202
		Opn Eunts @.050, deg	-15
		Cls Eunts @.050, deg	37
		Duration @.200, deg	108

RPM Data

RPM Data looks much like a dynamometer data sheet which gives projected engine test results for each RPM tested.

Engine RPM

Is the engine crankshaft's rotational speed in revolutions per minute.

Brk Tq, ft-lbs

Is the brake torque produced by the engine measured in ft. lbs. Brake torque is the usable net torque at the engine's flywheel. See Appendix 2. This is the same as the torque numbers you see in advertisements and in dynamometer torque and HP curves.

Brake HP

Is the Brake HP produced by the engine measured in horsepower. Brake HP is the usable net HP at the engine's flywheel. See Appendix 2. This is the same as the HP numbers you see in advertisements and in dynamometer torque and HP curves. To calculate torque from HP or HP from torque, use the following formulas:

$$\text{Torque} = \frac{\text{HP} \times 5252}{\text{RPM}} \quad \text{HP} = \frac{\text{Torque} \times \text{RPM}}{5252}$$

Exh Pres, PSI

Is the average exhaust pressure after the exhaust port and exhaust manifold/header, but before the exhaust system (if any), measured in PSI. (In version 1.2 this was given in inches of mercury.)

Int Vac, "Hg Boost, PSI

Is the average intake vacuum or supercharger boost after the carburetor or throttle body (and supercharger/turbocharger if any) but before the intake manifold runners measured in "Hg during the intake stroke. If the engine is supercharged or turbocharged, the units are given in PSI boost.

Vol Eff%

Is the volumetric efficiency of the engine measured in %. The volumetric efficiency is the percent of air which actually enters and remains in the cylinder during each intake stroke, compared to the amount which could under perfect, unsupercharged conditions. The amount of air which can enter the cylinder under perfect conditions is the swept volume of the cylinder with air at the actual barometric pressure (Barometric Pressure and Elevation effects combined) and Intake Air Temp, deg F.

For example, if the swept volume is 50 cu in, the air density at the specific barometer and intake air temperature is .000044 lb/cu in, .0022 lbs (50 cu in x .000044 lb/cu in) is the amount of air which can enter the cylinder under perfect conditions. If only .0018 lbs actually enters the cylinder during the intake stroke, the volumetric efficiency is:

$$\text{Vol Eff\%} = \frac{.0018}{.0022} \times 100\% = 82 \%$$

During supercharging, if the engine ingests .0030 lbs each intake stroke, the volumetric efficiency is calculated as:

$$\text{Vol Eff\%} = \frac{.0030}{.0022} \times 100\% = 136 \%$$

If .0030 lbs enters the cylinder, but .0003 lbs goes straight through and ends up out the exhaust (called "short circuiting"), the Vol Eff% is:

$$\text{Vol Eff\%} = \frac{(.0030 - .0003)}{.0022} \times 100\% = 123 \%$$

See Shrt Circuit, %.

Actual CFM

Is the flow rate of fresh air into the engine measured in cubic feet per minute (CFM). This is measured at the entrance of the air cleaner or if no air cleaner is present, the carburetor(s) or throttle body(s). Since this is called "actual", it is not corrected to standard conditions as in earlier Engine Analyzer programs. Actual CFM should correlate more closely to actual dynamometer air flow measurements.

Fuel Flow, lb/hr

Is the fuel flow delivered by the carburetor(s) or fuel injectors in lbs/hr for either gas or alcohol. This does not include the fuel to combust nitrous oxide, which is assumed to come from a separate fuel delivery system and is identified as Ntrs Fuel in the test results.

For Gasoline, the fuel is assumed to be similar to octane (an expensive type of gasoline with an octane # of 100) in density (5.86 lb/gal), heating value (19,000 BTU/lb), and stoichiometric A/F (14.7). Drag Racing Gas is assumed the same except with a slightly higher BTU content. Gasoline fuel flows are calculated based on an optimum power A/F (air/fuel ratio) of 12.5:1. (Other differences between Gasoline and Drag Racing Gas are discussed in the A/F Mxtr Qlty output discussed later in this section.)

If your particular engine runs at 11.5:1 A/F, your engine burns 12.5/11.5, or 1.09 times as much fuel per unit of air as the Engine Analyzer Pro calculates. Multiply the Engine Analyzer Pros fuel flow by 1.09 to get fuel flows for an engine running at 11.5:1. To calculate fuel flows in gallons per hour (GPH), multiply lbs/hr by .171 (.171=1/5.86).

For example, the Engine Analyzer Pro calculates 145 lbs/hr fuel flow at peak HP, assuming 12.5:1 A/F.

Your engine runs at 12:1, instead of 12.5:1 A/F:

$$145 \text{ lbs/hr} \times \frac{12.5}{12} = 151 \text{ lbs/hr}$$

You need the flow in GPH to size a fuel pump:

$$151 \text{ lbs/hr} \times .171 = 25.8 \text{ GPH}$$

For alcohol, the fuel is assumed to be methanol with a density of 6.6 lb/gal and heating value of 8,600 BTU/lb. Fuel flows are calculated based on an A/F of 5.0:1. To calculate fuel flows in gallons per hour (GPH), multiply lbs/hr of alcohol by .152 .

Nitrous, lb/hr

Is the flow of nitrous oxide liquid in lbs/hr. This has been increased (more nitrous flow is required to produce a certain amount of HP) from what was used in version 1.2.

Ntrs Fuel, lb/hr

Is the fuel flow required for the nitrous oxide injected in lbs/hr for either gas or alcohol. The program assumes that this fuel is injected through a system separate from the carburetor or electronic fuel injectors. The total fuel burned by the engine is Fuel Flow + Ntrs Fuel. This has been increased (more fuel is required for a certain nitrous flow, or it is given a richer mixture) from what was used in version 1.2.

BMEP, PSI

Is Brake Mean Effective Pressure, in PSI which produced the work on the piston that actually made it to the flywheel. Mathematically it is calculated as:

$$\text{BMEP} = \text{IMEP} - \text{FMPEP}$$

Like IMEP and FMPEP, BMEP is a convenient way to compare power output for 2 very differently sized engines. If 50 cc motorcycle engine and a 500 CID Pro Stock engine are equally well designed, they should both put out similar BMEP levels, even if the Pro Stock motor makes 100 times more power.

A/F Mxtr Qlty, %

Is the A/F Mixture Quality rated in %, where 100 % means there is no power loss from poor A/F Mixture Quality. A/F Mixture Quality is the combined result of these separate effects:

- A/F Maldistribution where all cylinders do not get the same air and fuel. Some cylinders run leaner than optimum and some run richer.
- Fuel Metering where the fuel metering signal strength to the carb is less than required to atomize the fuel, or worse, not even pull fuel through the jets at all.
- Atomization of fuel in the chamber, which depends on many design variables and fuel properties. The Pro assumes that the higher the Octane rating of the fuel, the lower the Reid Vapor pressure and the less likely the fuel is to atomize. Obviously not all fuels have the same vapor pressure for a certain octane, so this trend is not necessarily true for all fuels. Alcohol is also assumed to be slightly more difficult to produce good A/F Mixture Quality, because of its large cooling effect.

The lower the A/F Mixture Quality, the lower the power output the Pro will project. Therefore, pay special attention to this number. This is a change from all other previous Engine Analyzer programs, which always assumed perfect A/F distribution and atomization.

BSFC, lb/HP-hr

Is the brake specific fuel consumption of the engine in lbs/HP-hr, or pounds of fuel per hour per horsepower. BSFC is a measure of how efficiently the fuel is being used to produce power at the crankshaft. A good BSFC is in the range of .40-.45 for gas and .95-1.10 for alcohol, near the torque peak RPM. The lower the BSFC, the more efficient the engine is at converting fuel into HP.

BSFC is based on total engine fuel flow, or Fuel Flow + Ntrs Fuel.

Thermal Eff, %

Is the thermal efficiency as defined in Appendix 2, expressed in %.

IMEP, PSI

Is the Indicated Mean Effective Pressure in PSI which produced the work on the piston. In simple terms, the IMEP is the average cylinder pressure during the expansion stroke which would have produced this amount of torque.

IMEP is a way of rating the indicated torque output of any size engine. For example, a 400 cubic inch engine which produces 450 ft lbs of indicated torque produces 170 PSI IMEP. A 40 cubic inch engine which produces only 50 ft lbs produces 189 PSI IMEP. Although the 40 cubic inch engine produces a only one ninth the torque, its higher IMEP shows that it is a more efficient design for producing torque.

"Leading edge" race engines produce from 280 to 300 PSI IMEP naturally aspirated (unsupercharged). You can use IMEP as a rating of your engine's potential. If the program predicts only 200 PSI IMEP, you have lots of unused potential for more power. If the program is predicting 350 PSI IMEP without supercharging, the program is predicting more power than is likely with current technology.

Frctn Tq, ft-lbs

Is the engine's friction torque in foot pounds. See Frctn HP.

Frctn HP

Is the engine's friction horsepower. This is the HP required to overcome all the rubbing, mechanical friction of the internal moving parts (bearings, rings, etc), oil pump, water pump and to drive any accessories. This does not include the HP to drive a belt driven supercharger. This is listed separately at the end of the Projected Performance report as Compressor HP.

Note: The friction calculated here is not the same as the friction measured during a dynamometer test where the engine is motored over by the dynamometer. See Motoring HP.

FMEP, PSI

Would be the average pressure on the piston (or amount of IMEP) required just to overcome the rubbing, mechanical friction of the engine which produces Frctn HP. Like IMEP and BMEP, FMEP is a method of rating the friction performance of engines of different sizes. For example, most engines will have an FMEP of 30 PSI at an engine RPM which gives an average piston speed of 2300 ft/min.

$$\text{Piston Speed} = \frac{2 \times \text{Stroke (inches)} \times \text{RPM}}{12}$$

Note: Checking to see if the Engine Analyzer Pro is calculating between 22-38 PSI of FMEP with a piston speed of 2300 ft/min is a good check of your Short Block specs. If the Engine Analyzer Pro friction is out of this range at approximately 2300 ft/min piston speed, check and possibly adjust the specifications which affect engine friction.

Mech Eff, %

Is the mechanical efficiency as defined in Appendix 2, expressed in %. Mech Eff includes the effect of Compressor HP from any belt driven superchargers.

Motoring HP

Is the HP required to motor the engine with a dynamometer. Motoring tests are conducted with electric dynamometers (where the dynamometer is driving the non-firing engine) to measure the engine's friction. Motoring HP includes all rubbing friction as indicated by Frctn HP, Pumping Work and Compressor HP horsepower.

Pumpng Work, HP

Is the work done by the piston to pull the fresh charge into the cylinder and push the exhaust charge out, calculated in horsepower. This is work the engine must do to run (like turning the oil pump) and therefore reduces the brake power of the engine. For that reason, it is expressed as a negative number.

If the engine is equipped with a supercharger, the Pumpng Work may be positive. In this case, the pressure in the intake manifold actually pushes the air into the cylinder and pushes the piston down on the intake stroke, making positive work and thus adding a small amount to the brake power at the crankshaft. However, the power to do this positive work, came from the Compressor HP used to drive the supercharger.

Note: The pumping work calculated here is not technically the work of the pumping loop. Technically, it is the PV loop from work done from BDC exhaust to BDC at start of compression.

Residual Exh, %

Is the fraction of the total charge in the cylinder after the intake valve(s) has closed which is left over (residual) exhaust from the previous power cycle. The residual exhaust is expressed as a mass fraction, not a volume fraction. Therefore, since the residual is hot, "left over" exhaust which is less dense than the cool fresh air/fuel charge; the volume fraction of residual is higher than the mass fraction.

For example, a 5% mass fraction of residual may mean a 10% volume fraction. This means 10% of the cylinder's volume is filled with left over exhaust, volume which can not be used to draw in fresh air/fuel charge, effectively reducing the volumetric efficiency 10% and power 10%.

To maximize power, you will want to reduce the Residual Exh %. In fact the Residual Exh can be negative, which indicates no exhaust from the previous cycle is left in the cylinder, but that some fresh air/fuel charge actually passed through the cylinder, out the exhaust during the overlap period without being burned. This condition is called "short circuiting" and is wasteful, giving poor fuel economy and emissions, but will maximize power output. See Vol Eff, % and Shrt Circuit, %.

Shrt Circuit, %

Is the percent of the fresh mass which "short circuits", or passes directly through the chamber and out the exhaust during overlap without being burned.

Exh Temp, deg F

Is the temperature of the exhaust gas in degrees Fahrenheit immediately after leaving the cylinder, in the exhaust port. The exhaust gasses are cooled considerably by contact with the exhaust port and the exhaust manifold or header. Therefore, exhaust temperatures measured downstream of the exhaust valve will likely be cooler than those calculated by the Engine Analyzer Pro, especially at lower RPMs.

However, in the actual engines some of the fuel may not burn completely in the cylinder but continues to burn in the exhaust port and manifold/header. In these cases, some engine's may exhibit higher exhaust temperatures than those calculated by the Engine Analyzer Pro, especially at retarded spark advance.

Mx Cyl Pres, PSI

Is the maximum pressure which occurs in the cylinder during combustion in PSI absolute.

Mx Cyl Tmp, deg F

Is the maximum temperature which occurs in the cylinder during combustion in degrees F.

In Port Temp, deg F

Is the temperature of the fresh charge as it enters the cylinder/chamber in degrees F. In this version, the program is including some fuel and nitrous evaporation effects which can cool the charge considerably. This was not considered in version 1.2. Depending on the type of intake manifold, air temperature and engine coolant temperature, the fresh charge picks up considerable heat along the intake runner and port/valve. This rise of temperature hurts volumetric efficiency and power and is indicated by In Port Temp.

Piston Spd, ft/min

Is the average speed of the piston in feet per minute. Piston speed is a useful way to rate the RPM induced stress level of the reciprocating components of engines of very different sizes. For example, engines with typical production parts can usually rev up to a piston speed on 2750 ft/min without overly stressing pistons, connecting rods, etc.

The equation for piston speed is:

$$\text{Piston Speed} = \frac{2 \times \text{Stroke (inches)} \times \text{RPM}}{12}$$

You can see that Piston Speed only depends on RPM and Stroke. An engine with a 4" stroke will reach 2750 ft/min at 4125 RPM, but an engine with only a 3 inch stroke can rev to 5500 before it reaches 2750 ft/min. Both of these engines will be putting approximately the same stress on the rods and pistons at these quite different RPMs. This is the reason 100 cc racing motorcycle engines can rev to 25000 RPM but 500 CID Pro Stock motors can only rev to 9000 RPM. See also Piston Gs @ TDC.

Piston Gs @ TDC

Is the piston acceleration in Gs where the piston changes direction at TDC. TDC is generally where the highest piston Gs occur. Internal stresses of many reciprocating components are directly related to piston Gs. For example, if piston Gs increase 25%, you need parts which are 25% stronger. Consult the manufacturer of your rotating and reciprocating components to determine their maximum G load ratings for various applications. See also Piston Spd, ft/min.

Coolant HP

Is an estimate of the total heat rejected to the coolant that the radiator must deal with. This includes the heat energy which is lost to the coolant through the cylinder walls, combustion chamber walls and through the top of the piston *plus* the energy lost through the exhaust ports and from the friction heat generated from the internal moving parts expressed in horsepower. (Including the heat from the exhaust port and friction is a change from version 1.2. This should make the program more useful for users trying to design cooling systems.) To convert HP to BTU/hr, multiply by 2545. For example:

$$\text{Coolant HP} = 45 \text{ HP} = 45 \text{ HP} \times \frac{2545 \text{ BTU/hr}}{\text{HP}} = 114525 \text{ BTU/hr}$$

Blow By, CFM

Is the amount of combustion gasses leaking past the rings, measured in CFM. The leakage area by the rings is defined by Cyl Leakage spec in the Short Block specs. This value should correlate with blow-by measured during dyno testing. Blow-by can be measured by:

- Disabling the PCV system (if any).
- Sealing the crankcase except for 1 exit.
- Running the engine at full power and measure all blow-by escaping from the 1 exit.

In Tune Prs, PSI

Is the average dynamic intake pressure from inertia tuning occurring at the critical period close to the intake closing event in 'PSI. Use this value to quickly see the strength of the intake tuning pulses. See Section 3.4 for graphing the cycle data Int Prs which is the instantaneous pressure upon which In Tune Prs is based. Also see Example 4.5.

Avg In Vel, ft/sec

Is the calculated (not actual) average velocity of the fresh charge in the intake runner in feet/second. This is a simplistic value, calculated by:

$$\text{Runner Velocity} = \frac{\text{Piston Velocity} \times \text{Piston Area}}{\text{Intake Runner Area}}$$

The actual velocity depends on volumetric efficiency, cam timing, intake pressure and temperature, etc. However, several "rules of thumb" have been developed about sizing runners based on calculated runner velocity. Most state that you should design the runner area for a calculated velocity of 250-350 feet/second for optimum intake tuning.

The Engine Analyzer Pro does not use these "rules of thumb" concerning Avg In Vel in its performance projections. It is reported only for information. For example, if Avg In Vel is only 150 at the RPM you want good tuning (like your desired torque peak RPM), you may have to specify a smaller diameter intake runner and/or port diameter(s) for good performance. Likewise, if the program calculates 500 for Avg In Vel at your desired HP peak RPM (where you still want good tuning), the current intake runner and/or port diameter(s) may be too small.

Avg Ex Vel, ft/sec

Is similar to the preceding Avg In Vel. On the exhaust side, approximately 300 feet/second has been determined a good "target" for sizing header pipe diameters for optimum tuning. On the exhaust side, actual velocities are 2 to 3 times that calculated by Avg Ex Vel because of the high exhaust temperatures.

Mach

The 1979 SAE (Society of Automotive Engineers) paper "An Analysis of the Volumetric Efficiency Characteristics of 4-Stroke Cycle Engines Using the Mean Inlet Mach Number, Mim", 790484, by Fukutani and Watanabe is the basis of this calculation. It

was an extension of the Mach Index characteristic first identified in the 1940s by C.F. Taylor and co-workers from MIT, "The Internal Combustion Engine In Theory and Practice", C.F. Taylor, 1985, MIT Press.

These papers state that an engine's air flow potential per cycle (volumetric efficiency) depends on its average intake flow coefficient, intake valve flow area, cylinder size, speed of sound in air and RPM. These five terms are combined into one value called the Mach Index, called Mach # by the Engine Analyzer Pro. In simple terms Mach # relates the average velocity of the intake charge past the valve to the speed of sound. The speed of sound is theoretically the maximum velocity possible past the valve, which would give a Mach # of 1.0. A Mach # of .4 states the average velocity is only 40% of the maximum possible velocity.

Taylor's work showed good correlation between volumetric efficiency and Mach # for several engines with conservative cam timing. The correlation showed that volumetric efficiency (and therefore power) would start to drop sharply when Mach # increased above approximately .55. However, more recent studies show poor correlation if intake cam duration increases significantly. The 1979 paper includes a correction for intake duration; the higher the intake duration, the lower the Mach #, and the higher the RPM for peak volumetric efficiency.

General "rules of thumb" concerning the Mach # include:

- Peak volumetric efficiency should occur in the range of .3 to .5 Mach # with no tuning effects
- Volumetric efficiency drops rapidly in the range of .6 - .8 Mach #

The Mach # is calculated based on the static intake valve flow area, not dynamic flow area which can be different due to valve train bending or tossing. See Act In FlowArea,%. The Engine Analyzer Pro does not use Mach # in its calculations, but reports it only for information.

Act In FlowArea, %

Is the dynamic valve flow area compared to static valve flow area in percent. If the valve train had no bending and no tossing (like turning Valve Train Dynamics Off) this value will be 100%. Generally the dynamic valve flow area will be less than the static area due to bending, giving Act In FlowArea values of 93 - 98. This means the valve is allowing only 93-98 % as much flow potential as the cam is telling it. If you encounter valve toss, Act In FlowArea may be 101% or more, saying the valve is allowing more flow potential than the cam is telling it to allow.

Note: This is not the same as dynamic lobe area vs actual lobe area. During valve toss, the valve may be lifted much more than dictated by the cam lobe. However, if the extra lift occurs at high lift, you may get no increase in flow area. That's because high lift flow area is limited by the port's throat area, not valve lift. See Figure 2.9.

Act Ex FlowArea, %

See Act In FlowArea,% above.

Valve Toss

Indicates that dynamic valve motion has significantly higher lift than the theoretical valve motion (i.e. the follower has separated significantly from the camshaft). Valve Toss is not a definite condition that can be accurately predicted. Valve Toss here simply means that there is a high likelihood the valve spring can not hold the valve train and follower in contact with the cam. Valve Toss will be listed as None, Int, Exh or In&Ex to indicate if valve toss is likely to occur and on which valve. If Valve Train Dynamics are turned Off in the Cam/Valve Train menu, this output will be blank unless hydraulic lifter pump up has occurred. Then it will be marked PmpUp, but there is no indication if the pump up occurred on the intake, exhaust or both.

Valve toss depends strongly on the specific cam profile. The Engine Analyzer Pro's standard lobe profiles are a compromise, which may likely not exactly simulate your particular cam profile. For improved accuracy simulating valve train dynamics, use a detailed cam profile file like a Cam Dr file.

With mechanical (solid) followers, the actual engine's power may increase when valve toss conditions are reached. That is because the valves are being opened higher and longer than dictated by the cam. This is shown when Act In FlowArea and Act Ex FlowArea increases. Power may also drop off due to valve bounce. Valve bounce is when the valve is not gently returned to the valve seat by the cam's closing ramp, but is allowed to slam into it. The force of the valve slamming into the valve seat may cause it to bounce off the seat at a critically bad time, causing a loss of cylinder pressure and power. With hydraulic lifters the actual engine's power is almost always likely to fall off sharply when valve toss conditions are reached. That is due to lifter "pump up" holding the valves off their seats, allowing cylinder leakage. The Engine Analyzer Pro simulates this power loss both with solid and mechanical lifters with Valve Train Dynamics turned On. With Valve Train Dynamics turned Off, this power loss is only simulated for an estimated typical valve train with hydraulic lifters.

Knock Index

Indicates the likelihood that the engine will detonate, spark knock, or "ping" at this RPM with these conditions. Use Table 2.15 to interpret the Knock Index.

Table 2.15 Knock Index Definitions

Knock Index	Definition
Greater than 2	Detonation is very likely. The higher the Knock Index value is above 2, the more likely severe engine damage will result, i.e. holes in pistons, etc.
1.0-2.0	Detonation may or may not occur, depending on factors difficult to model.
Less than 1	Detonation is unlikely.

Safety Note: Preignition is the process where a glowing hot spot in the chamber starts the combustion process before the spark plug ignites it. This is a completely different phenomena than detonation. Preignition is possibly more damaging to an engine than knock, and is **NOT** predicted by the Engine Analyzer Pro.

Spark Advnc, deg

Is the spark advance timing in degrees before top dead center (BTDC). See the spark parameters menu in the Calculation Conditions, Section 2.8.1.

Note: The spark advance calculated by the Engine Analyzer Pro for optimum performance is only an approximation based on limited information about the engine. Therefore, your particular engine may require several degrees more or less spark advance than given by Spark Advnc in the results.

Primary Jet

The recommended diameter of the primary main jet in inches or Holley jet #, depending on your choices in the Preferences menu at the Main Menu. This size should deliver the Pro's assumed optimum power A/F of 12.5 for gasoline or 5.0 for alcohol. This calculation is based on numerous carburetor assumptions and simplifications. See fuel delivery specs in Section 2.4, Intake System.

The goal of most carburetor systems is to deliver the same A/F at all RPMs. This would be the case if the recommended Primary Jet reported here was exactly the same at all RPMs. By adjusting the various carburetor specs under Intake System specs, you can see how this goal can be reached.

Primary Jet is not reported if the Intake System Manifold Type is fuel injected.

WARNING: Although recommended jet sizes may work well in some cases, do not use them to jet your carb. Due to the many carb assumptions made by the Pro, recommended jet sizes should only be used to show trends.

Secondary Jet

The recommended diameter of the secondary main jet in inches or Holley Jet #. See the preceding Primary Jet explanation. Secondary Jet is not reported if the Intake System Manifold Type is fuel injected.

WARNING: Although recommended jet sizes may work well in some cases, do not use them to jet your carb. Due to the many carb assumptions made by the Pro, recommended jet sizes should only be used to show trends.

Injctr Dty Cyc, %

The recommended duty cycle in percent to deliver optimum power A/F for this RPM. Duty cycle is a way of saying what % of the time is the injector open. If this value is greater than 100%, it means the engine requires more fuel than these injectors can provide, even if they were open "full time". To provide enough fuel flow, you would have to increase the injector flow rating or fuel pressure. The Engine Analyzer Pro assumes a .8 millisecond "lag" for opening or closing the injector. The lag of your injectors and EFI system may be quite different.

Injctr Dty Cyc is not reported if the Intake System Manifold Type is as carbureted.

Inj Plse Wdth, ms

The recommended pulse width in milliseconds to deliver optimum power A/F for this RPM. For example, if Inj Plse Wdth is 24.5, it is saying the injector should be open 24.5 milliseconds (.0245 seconds) every time it fires. Also see the preceding Injctr, Dty Cyc explanation.

Inj Plse Wdth is not reported if the Intake System Manifold Type is carbureted.

Calc Error

Occasionally the Pro can not obtain an assumed and final volumetric efficiency which agree within the accepted tolerance. The program then uses the average of the assumed and final volumetric efficiency for the final volumetric efficiency. Calc Error is set to the % difference between this average volumetric efficiency and final volumetric efficiency calculated.

To summarize, if Calc Error is 0, the Pro found an assumed and final volumetric efficiency within acceptable limits, and the Pro's test results for this RPM are accurate. If Calc Error is not 0, it represents the % difference (or error) between the volumetric efficiency reported and the actual volumetric efficiency calculated at this RPM.

Supercharger Outputs:

If calculations are made for supercharged or turbocharged engines, additional calculations are made and reported at the bottom of the Projected Performance report. If the engine is not supercharged or turbocharged, these outputs are left blank.

Compressor Eff, %

The thermal efficiency of the supercharger or turbocharger compressor.

Comprsr Pres Ratio

The pressure ratio produced by the supercharger or turbocharger compressor. For example, if the absolute pressure before the compressor is 14.7 PSI (standard barometric pressure) and the PR is 2.0, the absolute pressure after the compressor is $14.7 \times 2.0 = 29.4$ PSI. The boost pressure alone would be $29.4 - 14.7 = 14.7$ PSI.

Compressor HP

The engine HP required to run the supercharger's or turbocharger's compressor calculated in HP. If the engine has a belt driven supercharger, this is the power which must be transmitted through the belt (useful for belt sizing). For belt driven superchargers, this HP is also added into the Motoring HP and Mech Eff data reported by the program.

Compressor RPM

The RPM of the belt driven Roots or Centrifugal supercharger's compressor rotor or impeller.

Roots Vol Eff, %

The volumetric efficiency of the Roots compressor. For example, if the Volume/Rev is 200 but the compressor is only flowing 150 cubic inches of fresh air per revolution, Roots Vol Eff would be $150/200$ or 75%.

Turbo Wastegt, %

Signals that the turbocharger's waste gate is opening to control boost to the preset maximum level. If Turbo Wastegt is 0, the wastegate is closed and all exhaust is passing through the turbine. If not zero, Turbo Wastegt reports the percent of exhaust bypassed around the turbine to limit boost on the intake side.

Turbo Surge, %

Signals that the turbocharger compressor is operating near or completely within the surge range. Surge is a condition where air flow through the turbo compressor is much *less* than optimum. It is expressed as a percent of the surge CFM flow at the particular pressure ratio (PR) the turbo is currently operating. For example, if the surge line at PR=1.6 is at 200 CFM and the turbo is operating at PR=1.6 at 150 CFM, Turbo Surge would be reported as $(200-150)/200$ or 25%. Therefore, the higher the Turbo Surge value, the farther into the surge region.

Special Calculations

The Special Calculation Specs have been expanded in later versions. See Appendices 9 - 13 on pages 235-312 for more updated info.

Valve Flow & Cam Calculations

Overlap Area, deg*sq-in

This is the overlap flow area in units of degree-square inches. These units can be illustrated using the example below.

Example: If the Overlap Area was 4, it could mean that:

- A valve area of four square inches was open for one degree of crank rotation.
- A valve area of one square inch was open for four degrees of crank rotation.
- A valve area of .4 square inches was open for 10 degrees of crank rotation.
- Or any other combination which when multiplied together gives 4.

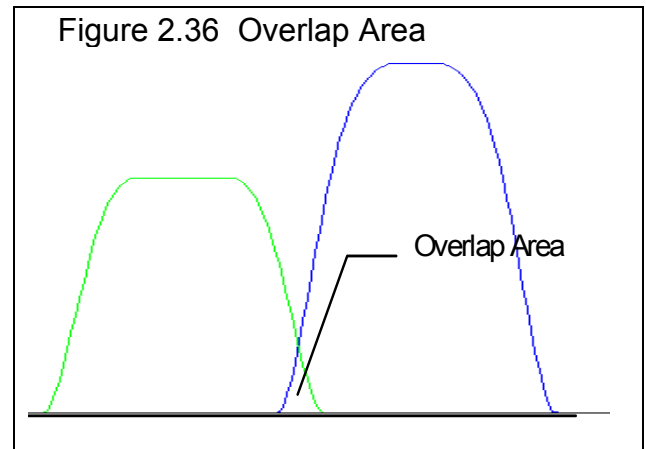

The phrase "valve area of X square inches was open" means that a perfectly flowing hole measuring X square inches was present between the exhaust and intake port for 1 crank degree. ("Perfectly flowing" means a flow coefficient of 1.0.)

At idle conditions on a street engine, this is when intake vacuum can pull residual exhaust into the intake manifold. The higher the Overlap Area, the higher the idle speed and the lower the idle vacuum.

Note: A larger cylinder can tolerate more Overlap Area. A 500 CID V-8 may idle at 1000 RPM with a given overlap area, but a 250 CID V-8 with the same overlap area could idle at 2200.

For race engines, overlap is generally needed for two reasons. First, it provides lower cam acceleration rates to attain the high lifts required for high RPM HP. Second, overlap can also improve performance by allowing for efficient purging of residual exhaust out of the clearance volume during overlap with proper intake and exhaust tuning. However, at "untuned" RPMs, overlap can increase the potential for intake reversion (reverse air flow up the intake runner from the cylinder) and poor scavenging. High overlap area can also lead to poor fuel economy through "short circuiting" (where intake charge passes through the combustion chamber out the exhaust system without being used).

Since turbocharged engines operate with high pressure and high temperature exhaust, Overlap Area is best kept to a minimum for turbocharged engines. This is both to reduce reversion (when high pressure exhaust flows backward into the intake) and exhaust temperatures (when "short circuited" fresh charges burns in the exhaust).

The Overlap Area is given here to compare overlap areas between different cam profiles, lash settings, and cylinder head flow potential. Check Idle Vacuum, "Hg in this section also to see how Overlap Area effects an important aspect of street engine performance.

Vlv Area, deg*sq-in

Is the valve opening flow area in units of degree-square inches, similar units to Overlap Area, deg*sq-in. This value represents the total effective flow area available for the intake or exhaust valves while they are open, not just when both are open. It is

Figure 2.37, Illustration of Vlv Area Calculation

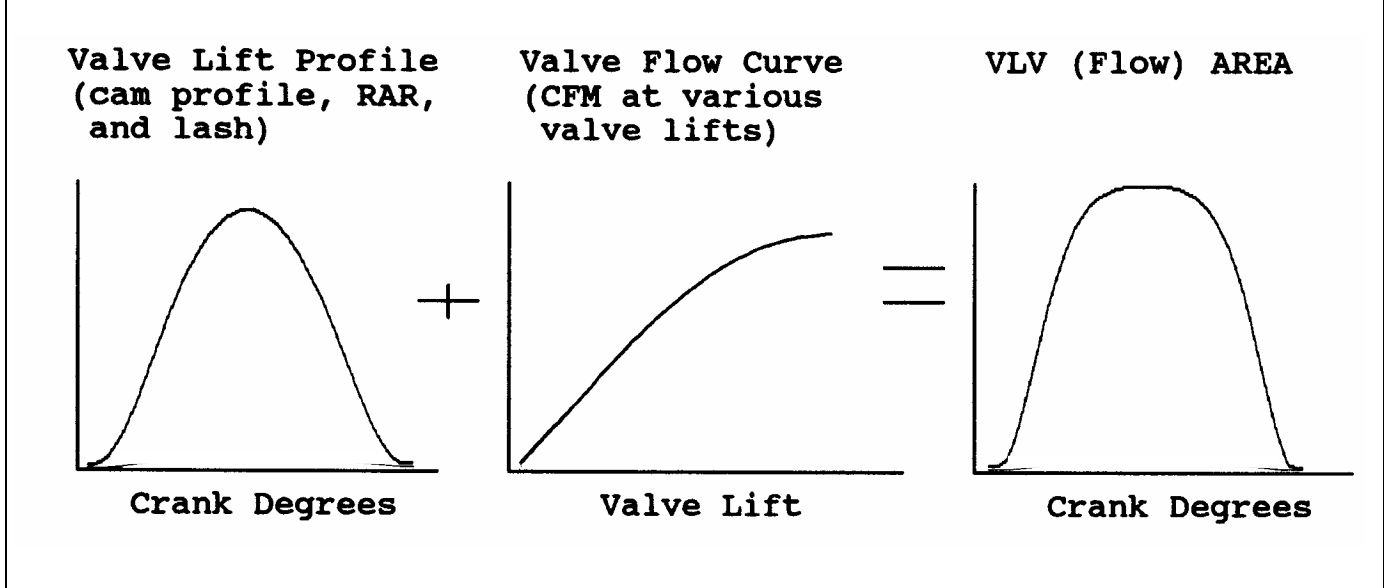

calculated from the valve lift curve and the valve flow curve. See Figure 2.37. Unlike flow coefficients, this value does increase directly as valve duration and valve size increases. It is these areas upon which Total Exh/Int, % is based.

The Vlv Area is given here to compare valve opening areas between different cam profiles, lash settings, valve sizes and flow coefficients. Also like Overlap Area, deg*sq-in, larger cylinders will require larger valve areas for similar volumetric efficiency.

Total Exh/Int %

This is the percentage ratio of total exhaust flow area to intake flow area. It is calculated as:

$$\text{Total Exh/Int \%} = \frac{\text{Exhaust Vlv Area, deg*sq-in}}{\text{Intake Vlv Area, deg*sq-in}} \times 100\%$$

"Rules of thumb" state that the exhaust port does not produce significant power losses until the exhaust flow potential falls below 75% of the intake flow potential. For supercharged or nitrous oxide engines this percent should increase to approximately 85%.

Total Avg Flow Coef

This is the average flow coefficient for the port, valve and runner for the time the valve is open. It shows how well the port flows compared to a "perfectly" designed port with a "perfect" cam profile. A perfect profile is defined as one where the valve opens immediately to a lift which gives maximum valve flow, stays open the entire duration, and immediately snaps shut at closing. Figure 2.38 compares the actual flow curve with the theoretically "perfect" flow curves to illustrate Avg Flow Coef.

The Total Avg Flow Coef will compare head and camshaft combinations. An engine with a Total Avg Flow Coef of 1.0 is physically impossible to build. In reality, the Total Avg Flow Coef will be approximately .25 for production engines, .30 to .40 for race 2 valve engines, and up to .50 or more for high RPM, 4 valve race engines.

Notes:

The average flow coefficient should not be confused with Intake or Exhaust Flow Coef in the cylinder Head(s) input specs. Intake or Exhaust Flow Coef applies only to one particular valve lift (L/D=.25) and the flow at that lift. The average flow coefficient applies to all valve lifts encountered for a particular cam profile, the portion of time at each lift, and the flow potential at each lift for the entire head.

Technically, the calculation of flow coefficient can vary significantly with the choice of valve opening and closing points. The lower the lift points chosen, the lower the flow coefficient. The Engine Analyzer Pro uses a relatively low lift of .003" at the valve to calculate average flow coefficient. Therefore, average flow coefficients calculated by the Pro are likely to be less than average flow coefficients from other sources.

Figure 2.38, Illustration of Total Avg Flow Coef

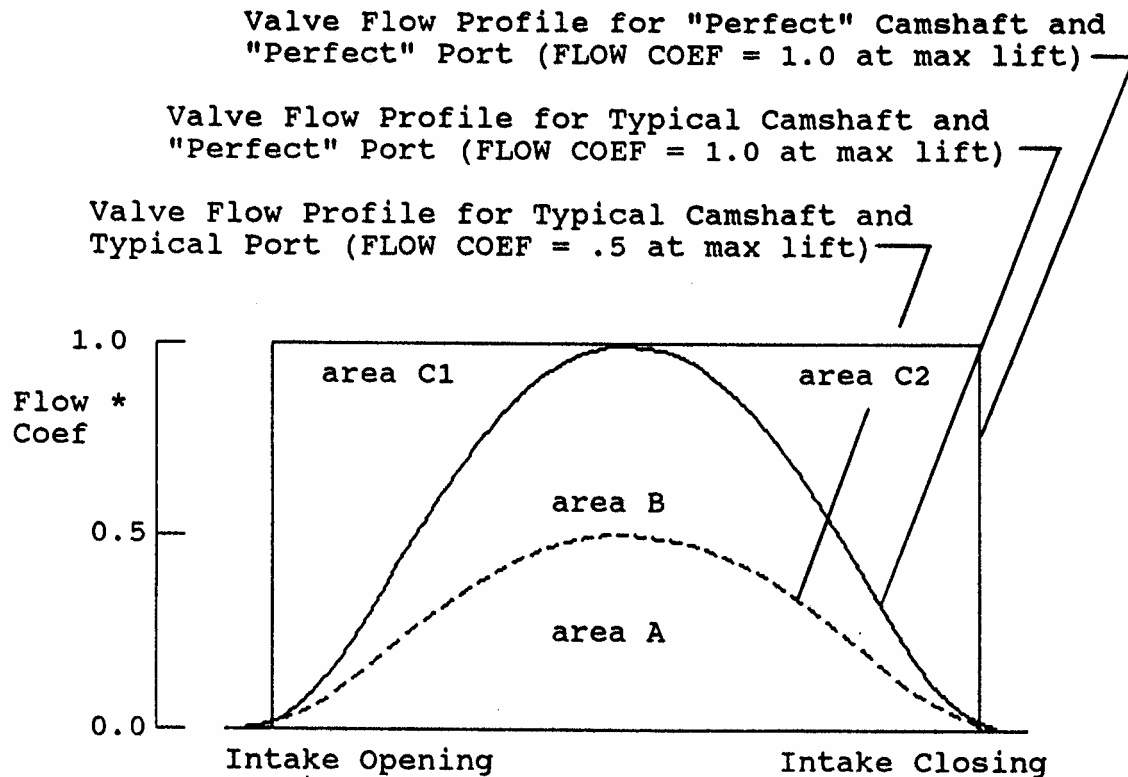

* Flow Coef is similar to VALVE FLOW COEF

$$\text{AVG FLOW COEF} = \frac{\text{area under typical cam/port flow profile}}{\text{area under perfect cam/port flow profile}}$$

$$= \frac{\text{(area A)}}{\text{(area A + area B + area C1 + area C2)}}$$

Lobe Separation, deg

Is the separation between the intake and exhaust lobe centerlines in camshaft degrees. The Engine Analyzer Pro assumes the centerline is where max lift occurs. You would have to double this value to obtain lobe separation in crankshaft degrees.

Lobe Area, inch*deg

Is the estimated area of the cam lift profile measured in tappet lift x cam degrees. See Figure 2.39.

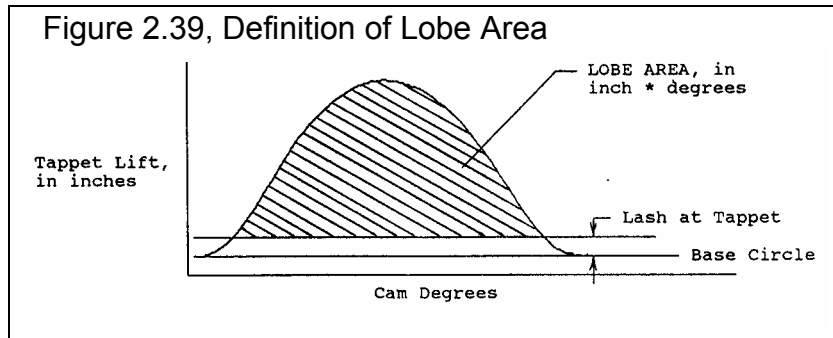

Overlap, deg

Is the number of crank degrees where both the intake and exhaust valves are open at least .003". This value should correlate approximately to most cam grinder's "advertised overlap".

Duration, deg

Is the number of crank degrees where the valve is open at least .003" for either the intake or exhaust. This value should correlate approximately to most cam grinder's "advertised duration".

Opening Events, deg

Is the location where the valve has reached .003" lift on the opening ramp. For the intake valve, this is reported in crank degrees BTDC (before top dead center). For the exhaust valve, it's reported in crank degrees BBDC (before bottom dead center). These values should correlate approximately to most cam grinder's "advertised opening events".

Closing Events, deg

Is the location where the valve has reached .003" lift on the closing ramp. For the intake valve, this is reported in crank degrees ABDC (after bottom dead center). For the exhaust valve, it's reported in crank degrees ATDC (after top dead center). These values should correlate approximately to most cam grinder's "advertised closing events".

Overlap @ .050, deg

Is the number of crank degrees where both the intake and exhaust tappet are lifted at least .050" above base circle. This value should correlate to most cam grinder's "overlap @ .050 inches lift".

Duration @ .050, deg

Is the number of crank degrees where the tappet is lifted at least .050" above base circle for either intake or exhaust. This value should correlate to most cam grinder's "duration @ .050 inches lift".

Opn Evnts @ .050, deg

Is the location where the tappet has been lifted .050" lift above base circle on the opening ramp. For the intake tappet, this is reported in crank degrees BTDC (before top dead center). For the exhaust tappet, it's reported in crank degrees BBDC (before bottom dead center). These values should correlate to most cam grinder's "opening events @ .050 inches lift".

Cls Evnts @ .050, deg

Is the location where the tappet has been lifted .050" lift above base circle on the closing ramp. For the intake tappet, this is reported in crank degrees ABDC (after bottom dead center). For the exhaust tappet, it's reported in crank degrees ATDC (after top dead center). These values should correlate to most cam grinder's "closing events @ .050 inches lift".

Duration @ .200, deg

Is the number of crank degrees where the tappet is lifted at least .200" above base circle for either intake or exhaust. This value should correlate to most cam grinder's "duration @ .200 inches lift". Events at .200 inches of lift are becoming more common in the aftermarket. This number gives you an idea of how aggressive the opening and closing ramps are. If the Pro's .050" duration matches your cam, but the .200" duration is too low, select a more aggressive Lifter (profile) type in the Cam/Valve Train specs menu.

Opn Evnts @ .200, deg

Is the location where the tappet has been lifted .200" lift above base circle on the opening ramp. For the intake tappet, this is reported in crank degrees BTDC (before top dead center). For the exhaust tappet, it's reported in crank degrees BBDC (before bottom dead center). These values should correlate to most cam grinder's "opening events @ .200 inches lift".

Cls Evnts @ .200, deg

Is the location where the tappet has been lifted .200" lift above base circle on the closing ramp. For the intake tappet, this is reported in crank degrees ABDC (after bottom dead center). For the exhaust tappet, it's reported in crank degrees ATDC (after top dead center). These values should correlate to most cam grinder's "closing events @ .200 inches lift".

Lobe Centerlns, deg

Intake and Exhaust lobe center is simply calculated from the appropriate .050" events and assumes a symmetric cam lobe (if using the standard Pro cam profile). If you are using cam profile data files, the Lobe Centerlns are based on the maximum lift point in the file. The intake lobe center is given in crank degrees after TDC, the exhaust lobe center is given in crank degrees before TDC.

Grss Tappet Lft

Is the maximum inches the tappet is lifted above base circle. If you are not using a cam lobe file, it is the same as Max Lobe Lift entered in the Cam/Valve Train specs.

General Engine Calculations

Displacement, CCs

Is the total engine displacement volume (swept volume) in cubic centimeters. This is based on the standard equation including bore, stroke and # cylinders. Divide this value by 1000 to obtain engine displacement in liters. For example, 4900 CCs is $4900 / 1000 = 4.9$ liters.

Displacement, cu in

Is the total engine displacement volume (swept volume) in cubic inches. This is based on the standard equation including bore, stroke and # cylinders.

Dynamic Comp. Ratio

Dynamic Comp Ratio is calculated like the Compression Ratio in the Head Specs menu except, the "swept" volume used is the cylinder volume at intake valve closing. Some people believe this is a more realistic compression ratio because the piston cannot compress the air until the intake valve has closed.

$$\text{Dynamic Comp. Ratio} = \frac{\text{Clearance Volume} + \text{Cyl Vol @ Intake Valve Closing}}{\text{Clearance Volume}}$$

The Dynamic Comp. Ratio is always less than the standard Compression Ratio, and ranges from 6 to 9 for most engines. You've probably heard that long duration cams need higher compression ratios. You will notice that when you specify long duration cams, with late intake valve closing, you must also specify a higher Compression Ratio to maintain a Dynamic Comp. Ratio in the range from 6 to 9.

Compression Ratio

Simply restates the specified Compression Ratio in the Head Specs menu for comparison to Dynamic Comp. Ratio.

Theo. Crank Comprsn,PSI

Is the estimated cranking compression pressure in pounds per square inch based on compression ratio, estimated intake cam profile and lash. The calculation assumes some heat losses and leakage (uses ratio of specific heats of 1.3 rather than 1.4). Your actual cranking compression (100-200 RPM) will likely be less due primarily to leakage and heat losses. Actual compression pressures can be higher with hydraulic lifters, especially high leakdown lifters. High RPM compression (1000 RPM or higher) would more closely match this value. Theo. Crank Comprsn is reported simply to show trends.

Note: The Cylinder Leakage value in the Short Block Specs menu is *not* used here to adjust Theo. Crank Comprsn. A standard leakage rating is always used

A new Preference in v3.9 has new options for calculating Cranking Compression. See Appendix 11 on page 261 for more updated info.

Clearance Volume, CCs

Is the calculated total clearance volume in cubic centimeters (piston dish/dome, chamber volume, deck and gasket volume) based on the given Bore, Stroke, Compression Ratio.

Pk Secondary Tuning RPM

Is the RPM which exhibits the greatest "secondary" or low speed tuning effects. Secondary tuning effects are explained in Appendix 3. If no secondary tuning effects are present, this value is left blank or marked "na".

Idle Vacuum, "Hg

Is the estimated idle vacuum at 1500 RPM, with no load on the engine (no torque converter). The Engine Analyzer Pro assumes a constant Barometric Pressure of 29.92 and typical dynamometer testing accessories (water pump, but no fan, power steering, alternator, air conditioning, etc.

'Starting Point' Specs For HP Peak @ xxxx RPM

These 'Starting Point' specs are for users who want help choosing "ball park" cam specs and/or runner sizes for good performance at a particular RPM. These recommendations are very general, being based on very simplified "rules of thumb". They are based on the current cam specs, bore, stroke, etc. Therefore, you will get somewhat different recommendations as engine specs change.

The RPM for these recommendations is entered in the Calculation Conditions menu under the heading 'Starting Point' Recommendations as Tuning Recommendations RPM. See page 67.

Notes:

Veteran engine builders can likely pick better 'Starting Point' Specs than the Pro simply from their experience. The "fine tuning" of these specs through detailed, "cut and try" analysis on the computer is the Pro's real strength.

The Engine Analyzer Pro does not calculate volumetric efficiency and performance from the same formulas which generate these runner or cam recommendations. Therefore, these runner recommendations may not produce the best performance in the program, but are simply good starting points.

A new Preference in v3.3 lets you turn Off this calculation. The program now comes with this calculation turned Off and hidden to avoid having users think that this calculation was more accurate and sophisticated than it really was.

Intake Dimensions (for x Runner/cylinder):

The following sets of lengths and areas/diameters are 2 combinations which are tuned to the RPM specified. The notation in parentheses identifies if the areas and diameters assume 1 or 2 runners per cylinder. This assumption is based on the # Valves/Ports in the Intake section of the Head(s) menu. For example, the area given for 2 runners per cylinder will be approximately half the area recommended for 1 runner per cylinder.

Note: These lengths and areas are based on simplistic "rules of thumb" concerning inertia tuning described in Appendix 3. The actual tuning simulated by the Pro is more detailed and may not completely agree with these recommendations. Therefore, use the recommendations in this section as a guide, or starting point for choosing runner sizes.

Recommended Length, in and Rec area sq in/in

Is the recommended total length of the intake runner from the valve seat to the first abrupt opening for good inertia tuning and runner velocity. This is the sum of Port Length plus Runner Length in the cylinder Head(s) and Intake System menus. This abrupt opening could be a plenum, branching together with another intake runner, or an opening to atmosphere. See Runner Length under Intake System.

Given to the right of the recommended length is recommended runner inside cross sectional area in square inches and inside diameter in inches. This area will give adequate runner velocity for this length runner at this RPM. If you have a rectangular runner, calculate the recommended width and height from the following formulas:

$$\text{Rec Width} = \frac{\text{Rec Area}}{\text{Current Runner Height}}$$

$$\text{Rec Height} = \frac{\text{Rec Area}}{\text{Current Runner Width}}$$

For example, if the recommended area was 2.08 sq in, and your current runner was 1.8 x 1.0:

$$\text{Rec Width} = \frac{2.08}{1.8} = 1.16''$$

$$\text{Rec Height} = \frac{2.08}{1.0} = 2.08''$$

You could either enlarge the width from 1.0" to 1.16" or enlarge the height from 1.8" to 2.08" to obtain the recommended area, but not both. If you want to increase both width and height, the final dimensions multiplied together should equal the recommended area.

Current Length, in and Rec Area sq in/in

For many intake manifolds, it is significantly easier to change the runner area than change the runner length. Current Length is the current total runner length specified by Port Length plus Runner Length in the cylinder Head(s) and Intake System menus. The area and diameter given will give good inertia tuning for this engine and this specified runner length. However, runner velocity may not be optimum. Also see Recommended Length and Rec Area above.

Exhaust Dimensions (for x Runner/cylinder):

Similar to the intake recommendations, the assumed number of exhaust runners per cylinder is also stated in parentheses. This assumption is based on the # Valves/Ports in the Exhaust section of the Head(s) menu. For example, the area given for 2 runners per cylinder will be approximately half the area recommended for 1 runner per cylinder. For example, the area given for 2 runners per cylinder will be approximately half the area recommended for 1 runner per cylinder.

Rec Len, 1st Pulse and Rec Area, 300ft/sec

Is the exhaust runner length to produce strong resonance tuning for this engine. This resonance pulse is from the first reflection and is usually the strongest pulse available for exhaust resonance tuning.

The area and diameter given will produce an average "calculated" exhaust runner velocity of 300 ft/sec. Several sources state this velocity gives good exhaust inertia tuning. The Pro's detailed calculations do not use this simple "rule of thumb" but it is a good starting point for many engines.

Rec Len, 2nd Pulse and Primary Tube O.D.

Is the exhaust runner length to produce strong resonance tuning for this engine. This resonance pulse is from the second reflection and is usually not as strong as the first pulse.

The diameter given is for the outside diameter of 18 gauge tubing which will give a "calculated" exhaust runner velocity of approximately 300 ft/sec. Also see Rec Len, 1st Pulse and Rec Area, 300 ft/sec.

Approx Cam Specs for HP Peak @ xxxx (based on current cam):

The following cam specs are estimated to produce a HP peak at the RPM specified above as @ xxxx. These recommendations are based on these assumptions:

- HP peak will appear at certain MACH #s. MACH # is based only on intake valve flow potential, intake cam profile and engine size. See MACH # definition on a previous page.
- Tuning effects are not included, which have a large impact on the particular cam profile and cam timing (lobe centerline) to use.
- Changes in cam duration and lift will produce predictable changes in intake valve flow potential. The more different the current cam's specs are from the recommended cam's specs, the more error in this assumption.

Therefore, it is obvious that these recommendations can not accurately predict what camshaft to use for a particular application, but are only a starting point. These recommendations must be optimized by calculating performance with the Pro, making small changes to these cam specs and then recalculating performance.

Notes:

The reliability of these recommendations depends on how close the current cam's specs are to the recommended specs. If they are significantly different (i.e. current duration is 200 degrees and recommended duration is 300 degrees), the recommendations will not be as reliable. In these cases, enter the recommended cam specs in the Cam/Valve Train menu and recalculate performance. The new cam recommendations will be more reliable.

The duration recommendations are limited to 320 degrees maximum and .550" lift maximum.

HP Pk Int Dur @ .050 and HP Pk, Int Tappet Lift

Is the recommended intake duration at .050" tappet lift to produce a HP peak at the specified RPM. The Tappet Lift is a typical lift for a cam lobe with this duration @ .050" designed for a typical American, pushrod V-8.

HP Pk, Exh Dur @ .050 and HP Pk, Exh Tappet Lift

Is the recommended exhaust duration at .050" tappet lift to produce approximately 75% exhaust flow area compared to intake flow area of the intake cam profile recommended. If the engine is currently supercharged or nitrous injected, this percent is raised to 85%. The Tappet Lift is a typical lift for a cam lobe with this duration @ .050" designed for a typical American, pushrod V-8.

2.9 Calculation Menus:

The following section explains the user input for engine specs listed with Clc buttons. These specs are ones where you can simply enter a value, or click on the Clc button and the program will present a menu of inputs which will calculate that particular parameter. These menus are like computer "scratch pads" for calculating specs like compression ratio, runner diameters from other inputs.

New Calculation Menus have been added or expanded in later versions. See Appendices 9 - 13 on pages 235-312 for more updated info.

Notes:

The starting values in each calculation menu are always blanked out. Once enough specs have been entered, the calculated value(s) at the top of the menu will be displayed. This calculated value(s) will now be updated each time you change a spec. If you want to use this calculated value, click on Use Calc Value. If the calculated value is within expected limits, it will be loaded into the original menu. If you click on Cancel, you will be returned to the original menu with the original value unchanged. If you click on Help, you will be given a general explanation of calculation menus, and a page # in this section for more info about the particular menu you are using.

The input values or calculated values in any calculation menu have NO affect on calculated performance unless you load the Calculated value into the original menu. ***If you already know a spec in the form required by the program, then you have no need to use the calculation menu.*** For example, if you know the Compression Ratio is 10.3, you have no need to use a calculation menu to calculate Compression Ratio based on Gasket Thickness, Piston Dome CCs, etc.

Example:

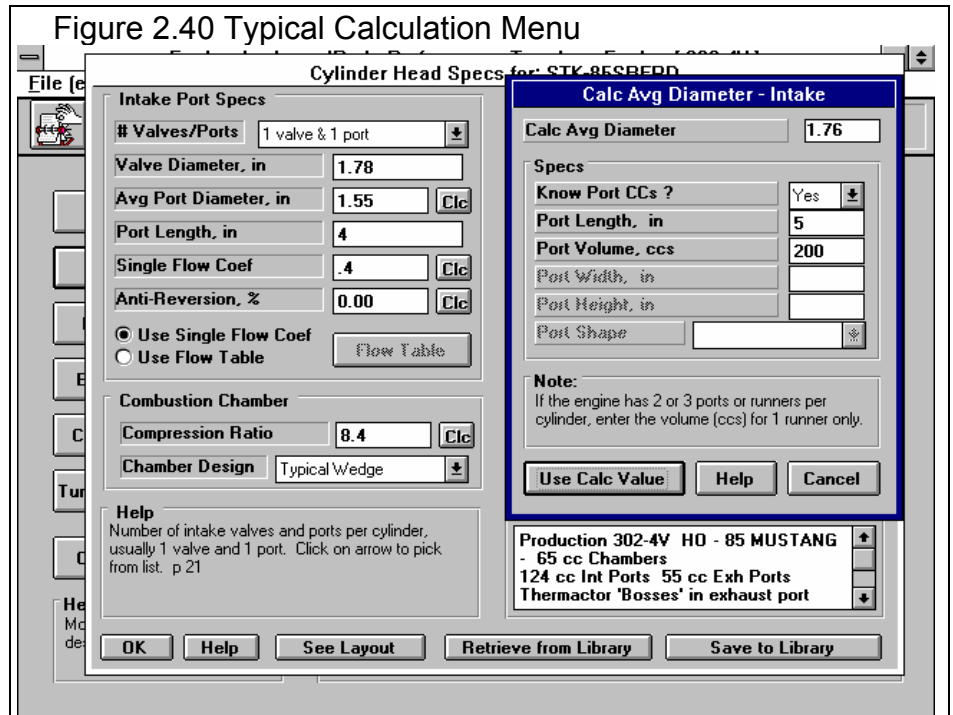

You are working with the SUPERSTOCK file for a Super Stock drag car. Assume you want to calculate the Avg Port Diameter for the intake port in the cylinder Head(s) menu for a new cylinder head. You click on the Clc button for Avg Port Dia and are shown the Calculation Menu shown in Figure 2.40. Note that all inputs are blank and only the Know Port CCs? spec is enabled (not dimmed to gray).

Click on the combo box arrow for Know Port CCs? spec to answer the question Yes or No. Lets say you select Yes, because you do know the port CCs. This is usually the more accurate way to measure average port diameter. The specs of Port Length and Port Volume are now enabled (printed in black, not gray). You enter in the values for the new head of Length of 5 inches and a Port Volume of 200 CCs and obtain a Calc Avg Diameter of 1.76. If you click on Cancel, you will return to the cylinder Head(s) menu with Avg Port Diameter at its original value of 1.78".

If you had checked on Use Calc Value, you would have returned to the cylinder Head(s) menu with Avg Port Diameter set to the new calculated value of 1.76. If you now calculate performance, it will be based on the new Avg Port Diameter of 1.76".

2.9.1 Calc Bearing Size

Is the Bearing Size calculated from the following specs. Bearing Size is defined on page 14 under Short Block specs. See page 97 for general notes on Calculation Menus and for an example of their use.

Bearing size is very dependent on engine Bore and # Cylinders. The Notes section at the bottom of this menu show these current settings in the program. If these are incorrect, click on Cancel and change these two specs before going using this menu.

Main Bearings

Main Bearing Diameter; in
Main Bearing Width; in

These 3 specs define the size of the main crankshaft bearings, which support the crankshaft in the block. If the bearings are not all the same size, use the size of the most common main bearing. See Figure 2.41 for definitions of Diameter and Width measurements in inches. "Micrometer" accuracy is not necessary, measurements within .05 inches are sufficient.

Examples: The # Main Bearings for a V-8 is usually 5; for a "truck" inline 6 cylinder, usually 7; single cylinder, usually 2; in line 4 cylinder, usually 5, etc.

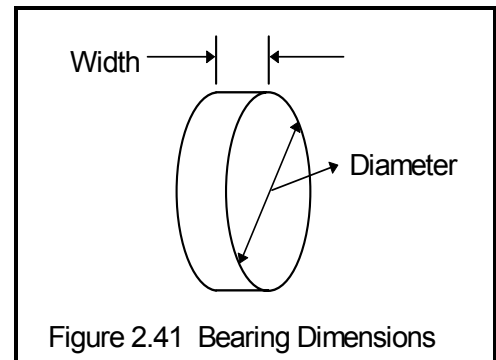

Rod Bearings

Rod Bearing Diameter; in
Rod Bearing Width, in

These 3 specs define the size of the connecting rod bearings. See Figure 2.41 for definitions of Diameter and Width measurements in inches. "Micrometer" accuracy is not necessary, measurements within .05 inches are sufficient.

The # Rod Bearings is almost always equal to the # cylinders.

Cam Bearings

Cam Bearing Diameter; in
Cam Bearing Width, in

These 3 specs define the size of the camshaft bearings. If the bearings are not all the same size, use the size of the most common cam bearing. See Figure 2.41 for definitions of Diameter and Width measurements in inches. "Micrometer" accuracy is not necessary, measurements within .05 inches are sufficient.

2.9.2 Calc Total Inertia

Is the Total Inertia calculated from the following specs. Total Inertia is defined on page 16 under Short Block specs. See page 97 for general notes on Calculation Menus and for an example of their use. The equation for Total Inertia depends on the engine displacement. This displacement is based on the current Bore, Stroke and # Cylinders in the Short Block menu and is displayed in the Notes section at the bottom of this menu. Make sure this displacement matches the engine for which you are calculating Total Inertia, before using this menu.

Remember, that Engine Inertia, Lb x Ft² is a combo box in the Short Block Specs menu. You can just select a typical description from the list (by clicking on the combo boxes arrow button) and have the program estimate the system's total inertia.

Engine Specs Component Wts

This combo box lets you pick a general description of the engine's rotating and reciprocating components. This general description modifies the inertia of the base engine without the flywheel.

Flywheel Weight, lbs Flywheel Diameter; in

These 2 specs define the weight and diameter of the engine flywheel. The engine flywheel makes up most of the engine's rotating inertia, and is why it is the only engine component itemized. In a vehicle installation, the flywheel weight should include the clutch disk and pressure plate. For a dynamometer installation, this represents all rotating adapters, flanges, etc mounted between the crankshaft and the dynamometer input shaft.

Although all these components can be of different diameters, use the diameter of the heaviest component.

Dyno Specs Rotating Mass Weight, lbs Rotating Mass Diameter

These 2 specs define the weight and diameter of the dynamometer. For small water brake dynos, these values are in the range of 20-40 lbs and 8"-12" in diameter. Unless you have measurements, we recommend using 25 lbs and 9" for water brake dynos. For large electric dynamometers, these values can be hundreds of pounds and 20"-30" in diameter. However, large electric dynos are rarely used for accelerating tests, where inertia is a factor.

Figure 2.42 illustrates the relationship between acceleration, rotating inertia and torque measurement.

Figure 2.42, Example of Torque Loss to Inertia While Accelerating with Dyno Inertia Being Twice as Large as the Engine/Flywheel Inertia (neglecting engine friction)

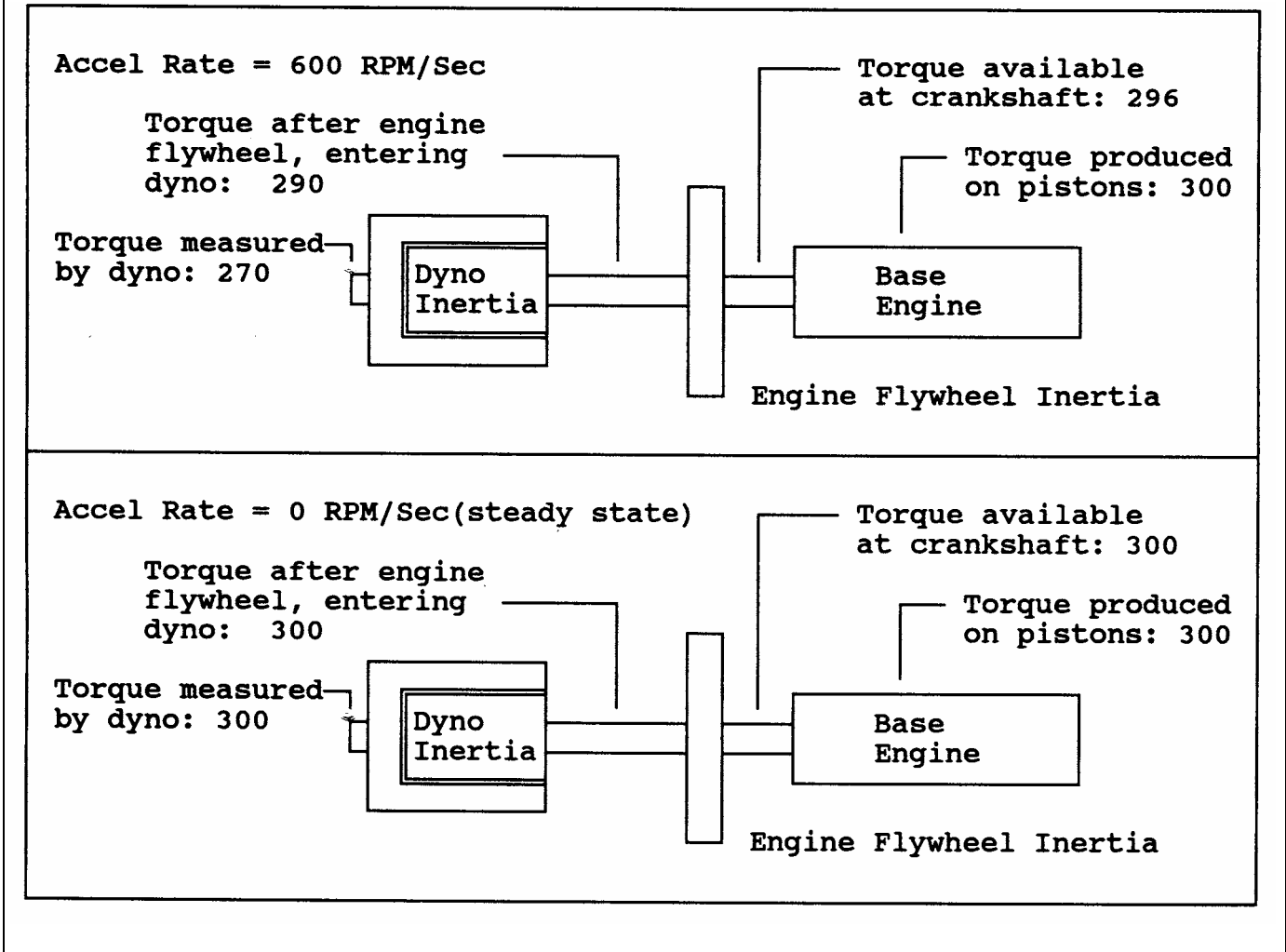

2.9.3 Calc Avg Port Diameter

Is the Port Diameter or Runner Diameter calculated from following specs. Port Diameter is defined on page 17 under cylinder Head(s) specs. Runner Diameter is defined on page 25 under Intake System specs and on page 35 under Exhaust System specs. See page 97 for general notes on Calculation Menus and for an example of their use.

Know Port CCs?

Click on this combo box to select Yes or No. Your choice here will enable (turn to black print from gray and allow for inputs) different specs in this menu. You must select this choice first before any other specs in this menu can be entered.

Calculating Avg Diameter from volume is generally the more accurate method. If you are using intake runners with a significant amount of taper, answer No to Know Port CCs, and use the Width and Height at the head to estimate the effective diameter at the head. Then use the calculation menu to calculate Runner Taper. For exhaust headers, it is usually best to simply subtract .1" from the tubing OD to obtain the inside runner diameter.

Port Length, in

The length of the port or runner along its centerline in inches. For a port, this would start at the valve stem (center) location at the valve seat or valve throat. It would continue down the middle of the port to the manifold or header mating surface. For many intake ports, 5" is a typical length, for the exhaust port, 3" is more typical.

For an intake runner, this is the length from the cylinder head to the first "abrupt enlargement" upstream of the cylinder head. The "abrupt enlargement" can be several different things:

- The intake manifold plenum. The plenum is the open area where all the runners merge, directly under the carburetor(s) or after the throttle body on fuel injected manifolds. The best example of a plenum is the very evident "box" on "tunnel ram" type manifolds.
- The end which is open to atmosphere (or air cleaner) on individual runner fuel injection or carburetion. For individual runner carb systems, the runner length actually extends through the carb and through any velocity stack or air horn.
- Any point where a runner from one cylinder merges with a runner from another cylinder.

For an exhaust runner, this is also the length from the cylinder head to the first "abrupt enlargement" downstream of the exhaust port. On the exhaust side, the "abrupt enlargement" can be:

- The header collector where individual tubes merge together.
- The end which is open to atmosphere on individual runner exhaust headers.
- Any point where a runner from one cylinder merges with a runner from another cylinder.

Again, for the Exhaust Runner Diameter, it is usually best to simply subtract .1" from exhaust header tubing OD to estimate their inside runner diameters, rather than use this calculation menus.

Port/Runner Volume. CCs

Is the volume of liquid required to fill the port or runner in cubic centimeters. For a cylinder head, this is a common spec head manufacturers quote.

For an intake or exhaust manifold, you will likely have to measure this yourself. This measurement does not require the precision of "cc'ing" combustion chambers. That's because for most intake or exhaust manifolds there is no clear distinction where the runner ends. Cover the "manifold to head" mounting surface with a plate or heavy tape. Tip the manifold so you can pour in liquid from a graduated cylinder or other measuring device, through the carb or exhaust pipe opening. Fill until you believe the liquid is to the "abrupt enlargement" defined above.

Port Width, in

The average width of the port or runner along its entire length in inches. This can usually be estimated at the end of the port or runner at the cylinder head-manifold/header mating surface.

Port Height, in

The average height of the port or runner along its entire length in inches. This can usually be estimated at the end of the port or runner at the cylinder head-manifold/header mating surface.

Port Shape

Describes the general shape of the runner along its entire length. Your choices are:

- Rectangular
- Rounded Rectangular
- Oval

A purely Rectangular runner would have sharp corners and a purely Oval runner would be 2 semicircles connected by 2 straight sections. See Figure 2.43. Actual runners are likely somewhere between these two shapes, which is the Rounded Rectangular choice.

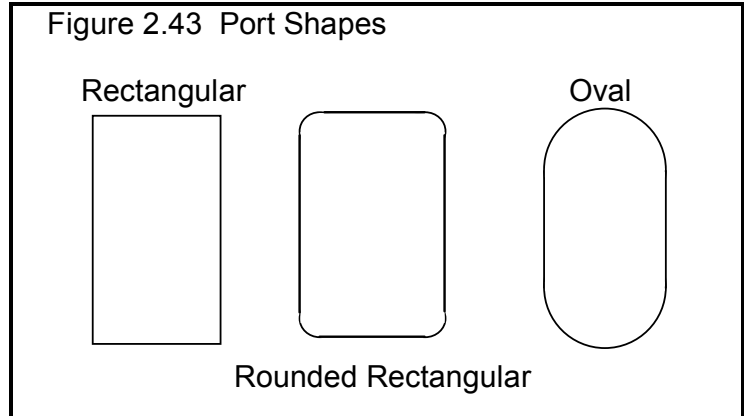

2.9.4 Calc Valve Flow Coef

Is the Flow Coef for either the intake or exhaust port and valve calculated from following specs. Valve Flow Coef is defined on pages 18-20 under cylinder Head(s) specs. You would use this menu if you have flow bench data at only 1 or just a few lift points. See page 97 for general notes on Calculation Menus and for an example of their use.

This Clc button is not enabled unless you have selected the Use Single Flow Coef option. Once enabled, if you click on it, you will be presented with the specs outlined below. These specs will be explained based on a typical flow curve shown in Figure 2.44.

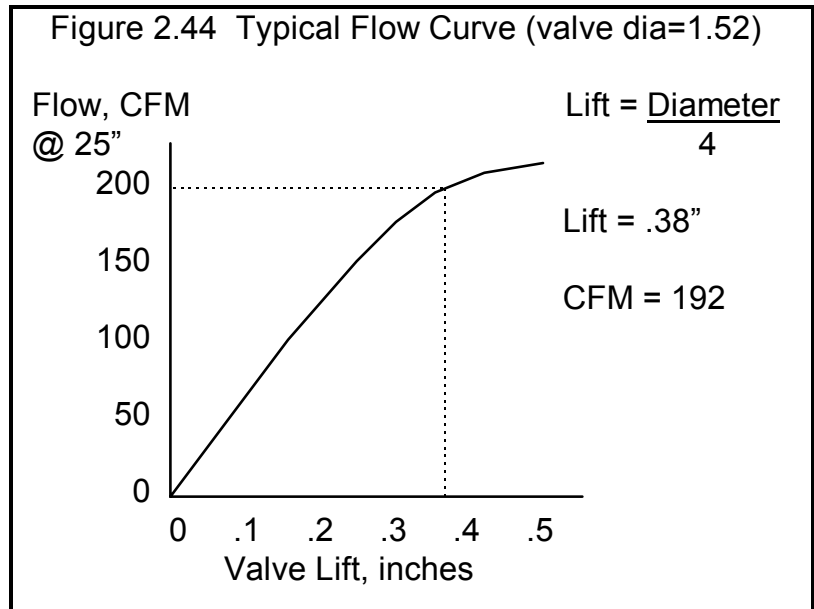

Test Pressure, "Water

Is the pressure drop maintained across the port and valve during the flow test, measured in inches of water. From Figure 2.44, you would enter 25. If you have test pressure in inches of Mercury, multiply by 13.6 to obtain "Water.

$$\text{Test Pressure, " Water} = \text{Test Pressure, " Mercury} \times 13.6$$

This is initially set to 28 when you enter this menu, because 28" is so common. However, you can change it to most anything you want. Ten (10) and 25" are other common flow bench test pressures.

Valves/Cylinder

The number of intake or exhaust valves being flowed during the test. Most cylinder heads have only 1 intake and 1 exhaust valve, so this value would be 1. This number is set to whatever is currently in the # Valves/Ports spec in the Head(s) menu for this port. If this is not correct for the flow test, you must change this in the Head(s) menu before using this calculation menu. You can not change this number in this menu.

Valve Diameter, in

Identifies the outside (largest) diameter of the head of the valve(s) in inches. From Figure 2.44, you would enter 1.52. This number is set to whatever is currently in the Valve Diameter spec in the Head(s) menu for this port. If this is not correct for the flow test, you must change this in the Head(s) menu before using this calculation menu. You can not change this number in this menu.

Valve Lift Tested, in

Is the valve lift at which the flow data CFM is measured. Use a valve lift (and corresponding CFM flow) as close as practical to one fourth the valve head's diameter. A range of lifts close to 1/4 the valve's diameter is given in the Notes at the bottom of this menu. The program will warn you when Valve Lift is not 1/4 of Valve Diameter in this menu. For example, for a 1.52" diameter valve, use flow (CFM) at .38" valve lift. CFM at .4 lift would also be acceptable. See Figure 2.44.

Note: This is *NOT* valve lift produced by the cam

Flow Obtained, CFM

Is the CFM flow obtained at the valve lift given for Valve Lift. Shown in Figure 2.44 is a typical flow curve from a flow bench. For this data you would use the 192 CFM value. For most conditions, it is best to install a radiused inlet on the intake and a short "stub stack" (see page 24 for a source) on the exhaust, rather than just flow the head only.

2.9.5 Calc Anti-Reversion

Is the anti-reversion for either the intake or exhaust port and valve calculated from the following specs. Anti-reversion is defined on page 22 under cylinder Head(s) specs. See page 97 for general notes on Calculation Menus and for an example of their use.

Flow -Normal Direction, CFM

Is the CFM recorded when flowing the head in the proper flow direction. For the intake port, you will be drawing air from the room; for the exhaust you will push air from the port into the room.

Many times the intake manifold or exhaust header have features to limit reverse flow. Therefore, perform this test with the intake manifold or exhaust header installed.

Generally, flow in the reverse direction only occurs during overlap or at intake closing, both of which are at small lift. It is therefore recommended that you check Anti-Reversion at a low lift, like .100" to obtain flow in both the normal and reverse direction. See Example 4.4.

Flow-Reverse Direction, CFM

Is the CFM recorded when flowing the head in the reverse flow direction at the same test pressure and valve lift as Flow-Normal Direction. For the intake port, you will be pushing air from the port into the room; for the exhaust you will drawing air from the room.

The recommended test procedure is given below and in Example 4.4:

- Install the head with either the intake or exhaust manifold installed on the head.
- Set a low valve lift, a lift of .100" works well.
- Flow the port in correct direction, recording CFM.
- Change nothing but the flow bench flow direction and immediately flow in the reverse direction, recording CFM.

2.9.6 Calc Compression Ratio

Is the Compression Ratio calculated from the following specs and the current cylinder volume (based on the current Bore and Stroke in the Short Block menu). Compression Ratio is defined on page 22 under cylinder Head(s) specs. See page 97 for general notes on Calculation Menus and for an example of their use.

The equation for Compression Ratio depends on the cylinder displacement. This displacement is based on the current Bore and Stroke in the Short Block menu and is displayed in the Notes section at the bottom of this menu. Make sure these specs match the engine for which you are calculating Compression Ratio before using this menu.

Chamber Specs Chamber CCs in Head

Is the combustion chamber volume in the cylinder head, measured in cubic centimeters. This is the value obtained if the heads are "cc'd".

If you know the entire clearance volume of the cylinder, but do not know Piston Dome CCs, Gasket Thickness or Deck Height Clearance, enter that volume here as Chamber CCs in Head. Then enter 0 for Piston Dome CCs, Gasket Thickness and Deck Height Clearance. The program will calculate compression ratio based on the equation below where Clearance Volume is the Chamber CCs in Head.

$$\text{Compression Ratio} = \frac{\text{Clearance Volume} + \text{Swept Volume}}{\text{Clearance Volume}}$$

Piston Dome CCs

Is the volume of the "pop up" in the piston measured in cubic centimeters. The "pop up" is the volume of piston material added to the top of a flat top piston. If the piston has a "dish" (depression), enter the dish volume as a negative (-) number.

Gasket Thickness, in

Is the thickness of the head gasket in inches after it has been "crushed". "Crushed" thickness is after the head bolts have been torqued to spec.

Gasket Bore Diameter, in

Is the diameter of the bore in the head gasket. A good approximation is to use the same as the Bore in the Short Block Specs menu, and this value is loaded in when you first open up this menu. You can change it to most any value you want. (In actual use, gasket bores are usually .030-.100" larger than the cylinder bore.)

Deck Height Clearance, in

Deck Height Clearance is the distance in inches from the top of the piston to the top of the cylinder block when the piston is at TDC. The top of the cylinder is the deck, or surface to which the head bolts. If the outer edge of the piston travels above the deck, this is called negative deck height and you must enter a negative (-) number.

2.9.7 Calc Runner Flow Coef

Is the intake or exhaust Runner Flow Coef calculated from the following specs. Runner Flow Coef is defined on page 26 under Intake System specs and page 36 under Exhaust System specs. Also see Section 2.9.4 describing Valve Flow Coef. See page 97 for general notes on Calculation Menus and for an example of their use.

Flow Data, Head Only Test Pressure, "Water

The pressure drop maintained across the port, valve and runner during both portions of the flow test, measured in inches of water. If you have test pressure in inches of Mercury, multiply by 13.6 to obtain "Water.

$$\text{Test Pressure, " Water} = \text{Test Pressure, " Mercury} \times 13.6$$

This is initially set to 28 when you enter this menu, because 28" is so common. However, you can change it to most anything you want. Ten (10) and 25" are other common flow bench test pressures.

Valves/Cylinder

The number of intake or exhaust valves being flowed during the test. Most cylinder heads have only 1 intake and 1 exhaust valve, so this value would be 1. This number is set to whatever is currently in the # Valves/Ports spec in the Head(s) menu for this port. If this is not correct for the flow test, you must change this in the Head(s) menu before using this calculation menu. You can not change this number in this menu.

Valve Diameter,in

Identifies the outside (largest) diameter of the head of the valve(s) in inches. This number is set to whatever is currently in the Valve Diameter spec in the Head(s) menu for this port. If this is not correct for the flow test, you must change this in the Head(s) menu before using this calculation menu. You can not change this number in this menu.

Valve Lift Tested, in

Is the valve lift at which the flow data CFM is measured. Use a valve lift (and corresponding CFM flow) as close as practical to one fourth the valve head's diameter. A range of lifts close to 1/4 the valve's diameter is given in the Notes at the bottom of this menu. The program will warn you when Valve Lift is not 1/4 of Valve Diameter in this menu. For example, for a 1.52" diameter valve, use flow (CFM) at .38" valve lift. CFM at .4 lift would also be acceptable. See Figure 2.33.

Note: This is **NOT** valve lift produced by the cam

Flow w/o Runner, CFM

Is the CFM flow obtained at the valve lift given for Valve Lift with only the cylinder head being flowed. This flow should be the maximum obtainable for the head only.

To obtain maximum flows, the entrance to the intake port should have an "optimum bell mouth" or "radiused" adapter for smooth air entry. The exhaust side may also benefit from installing a short (3-12"), straight section of smooth pipe. You can experiment by simply holding tubes of various lengths and diameters up to the exhaust port, to see the effect on flow. Once you know the approximate dimensions which give maximum exhaust flow, you may want to make a more permanent exhaust adapter for your flow tests.

Flow Data with x Runner

The x in this heading is to indicate you must flow all runners connected to this cylinder for this test. For example, if the engine has 2 intake valves and 2 intake runners for each cylinder, you must first flow both valves with no runner, then add both runners and flow it again.

Runner Diameter, in

Is the Runner Diameter you will use for this runner in either the Intake or Exhaust System menu. This value is initially loaded into this menu, but you can change if you want. If the runner is primarily oval or rectangular, use the Calc Runner Diameter calculation menu in the Intake or Exhaust System menu first to obtain an effective Runner Diameter.

Flow with Runner,CFM

Once you have the maximum flow value for the head only, Flow w/o Runner, install the manifold or header. At exactly the same valve lift and test pressure, repeat the test. Your flow value should drop. If it does not drop, obviously you did not have an optimum entrance or exit adapter, since the manifold you are now flowing is more optimum.

The Engine Analyzer Pro should calculate a value for Calc Runner Flow Coef of somewhere between 0.5 and 3.0. The larger the drop in flow between the head only and head plus manifold/header, the worse (smaller) the runner flow coef. However, like Valve Flow Coef, a small runner which reduces flow considerable, may have an excellent flow coefficient. This means it is well designed for its size, but its size is the restriction, not its design.

If you enter a Flow with Runner which is greater than or equal to Flow w/o Runner, the Engine Analyzer Pro simply calculates a maximum flow coefficient of 3.

Notes:

When flow testing an intake manifold, be sure the other runners are blocked off. Also, do not install the carburetor. The Engine Analyzer Pro treats the carburetor restriction differently from the valve, port and runner restrictions. Occasionally a manifold

may flow better with the carb or throttle body than without. In these instances, you should provide an "optimum entrance" at the carb pad, since the carb itself would be a significant restriction. An optimum entrance can be molded out of clay.

It may be more convenient to just flow the cylinder head with the intake and exhaust manifold/header installed, rather than trying to develop "optimum adapters". If this is what you want to do, see Example 4.4.

If you did not exactly have an "optimum" adapter for obtaining Flow w/o Runner, then your Valve Flow Coef will be too low and your Runner Flow Coef will be too high. Also see Examples 4.4 and 4.5.

Accurate determination of Runner Flow Coef has three advantages:

- You can more accurately swap manifold runners onto heads (in the computer) which have not been flowed together.
- You gain insight as to manifold and header flow restriction and design. Manifolds and headers with low flow coefficients have much potential for flow gains from redesign and porting. Flow restrictions from components with high flow coefficients indicate the size of the component is more of a restriction than its design.
- Runner Flow Coef has a significant effect on tuning, however this effect is not yet clearly understood. See Appendix 3.

2.9.8 Calc Taper, deg

Is the Taper angle for either the intake runner in the manifold or the collector of the exhaust header calculated from the following specs. Taper is defined on page 28 under Intake System specs and page 39 under Exhaust System specs. See page 97 for general notes on Calculation Menus and for an example of their use.

The equation for Taper depends on the length of the Intake Runner or Exhaust Collector. This length is based on the current settings of these specs in the Intake System or Exhaust System specs menus and is displayed in the Notes section at the bottom of this menu. Make sure this length matches the runner or collector for which you are calculating Taper before using this menu.

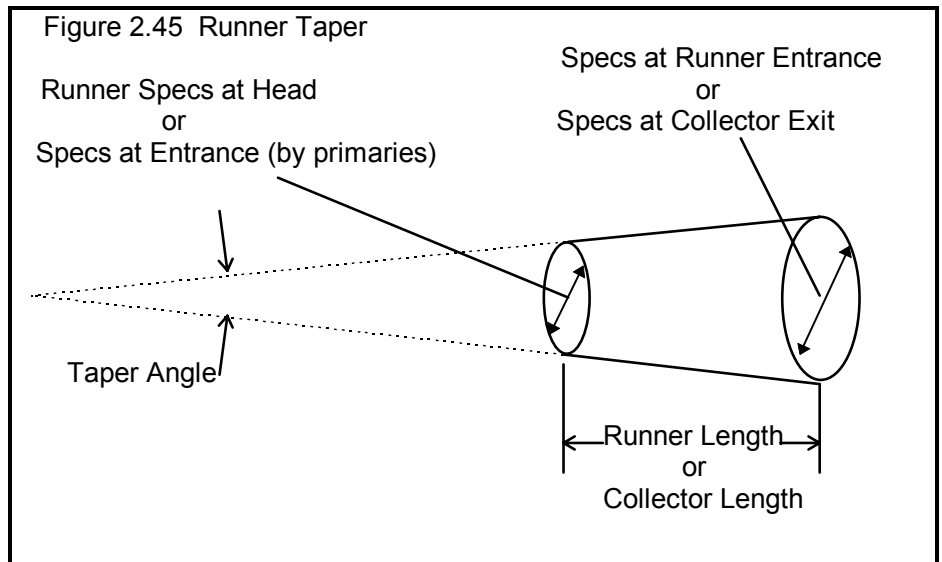

Runner Specs at Head or Specs at Entrance (by primaries)

Know

From this combo box, choose what you know about the end of the runner at the head or collector at the primary pipes. This is the end closest to the engine and is usually the smaller diameter or area. You can pick from 5 choices:

- Diameter, circular
- Area in square inches
- Width & Height, rectangular
- Width & Height, oval
- Width & Height, rounded rectangle

See Figure 2.43 for shapes for Width and Height options. Your choice here will enable or disable the other specs in this section of this menu.

Diameter, in

If the effective diameter of the end closest to the engine in inches. The appropriate value from either the Intake System or Exhaust System specs menu is initially loaded, but you can change this value. If you are not sure of this diameter, you should use a Calculation menu to obtain this value before using this menu.

Area, sq in

Is the area of the end closest to the engine, in square inches.

Width, in

Is the width of the end closest to the engine, in inches, for the particular shape you chose for the Know combo box described on the previous page.

Height, in

Is the height of the end closest to the engine, in inches, for the particular shape you chose for the Know combo box described on the previous page.

Specs at Runner Entrance Specs at Collector Exit

Know

Diameter, in

Area, sq in

Width, in

Height, in

These specs have the same definitions as those listed in the previous section Runner Specs at Head or Specs at Entrance (by primaries).

2.9.9 Calc CFM Flow Rating

Is the CFM Flow Rating calculated from the following specs. CFM Flow Rating is defined on page 29 under Intake System specs. See page 97 for general notes on Calculation Menus and for an example of their use.

You will first be asked:

Do you have flow bench data for estimating CFM rating ?

If you answer Yes, you will be presented with the specs outlined in 2.9.9.2. If you answer No, the following specs will be presented.

Note: The most accurate way to determine the CFM Flow Rating is to flow the component on a flow bench. The second best way is to use the manufacturer's CFM rating at 1.5" Hg, or rating at 3" Hg and convert it to 1.5" by multiplying by .71. Only if these other methods are not available, should you use the Calculation Menu based on diameter measurements.

2.9.9.1 Calc CFM Flow Rating

Total # Pri. Throttle Plates

The total # of primary barrels. For a single 4-V carburetor, this would be 2, for three 2 barrel carbs this would be 2.

Primary Throttle Dia, in

The diameter of the throttle opening or throttle butterfly plate for the Throttle Plates, not venturi diameter.

Total # Sec. Throttle Plates

The total # of secondary barrels. For a single 4-V carburetor, this would be 2, for three 2 barrel carbs this would be 4.

Secondary Throttle Dia, in

The diameter of the throttle opening or throttle butterfly plate for the Sec Throttle Plates, not venturi diameter. If Total # Sec. Throttle Plates is set to 0, this value is disabled (dimmed to gray) and ignored.

Note: Primary throttles and secondary throttles are not treated differently in this calculation menu. The only reason they are listed separately here is to easily handle throttle plates which are different sizes. For example, if the primary and secondary throttles were the same size in the three 2 barrel examples above, you could have used 6 Pri Throttles, 0 Sec Throttles and arrived at the same answer.

Restrictor Plate Specs

Restrictor Plate Installed

If the carb is used with a restrictor plate, choose Yes. Restrictor plates are special orifice plates mounted below (or after) the carburetor to limit power for special classes of racing. Chances are, if you do not know what a restrictor plate is, you would choose No here.

Restrictor Holes

The total # holes in the restrictor plate which all engine air must pass through. If Restrictor Plate Installed is set to No, this value is disabled (dimmed to gray) and ignored.

Hole Diameter; in

The diameter of each hole in the restrictor plate in inches. If Restrictor Plate Installed is set to No, this value is disabled (dimmed to gray) and ignored.

% Design Improved

This spec has to do with how the orifice plate is mounted, and what type of transition pieces can be installed on top and below the plate. A plate with no transition pieces and several inches between the carb and the restrictor plate would be called 0 % improved. Where class rules allow, the plate may be "sandwiched" between transition pieces, which can greatly improve flow. This could be called 100% improved. See Figure 2.46.

If Restrictor Plate Installed is set to No, this value is disabled (dimmed to gray) and ignored.

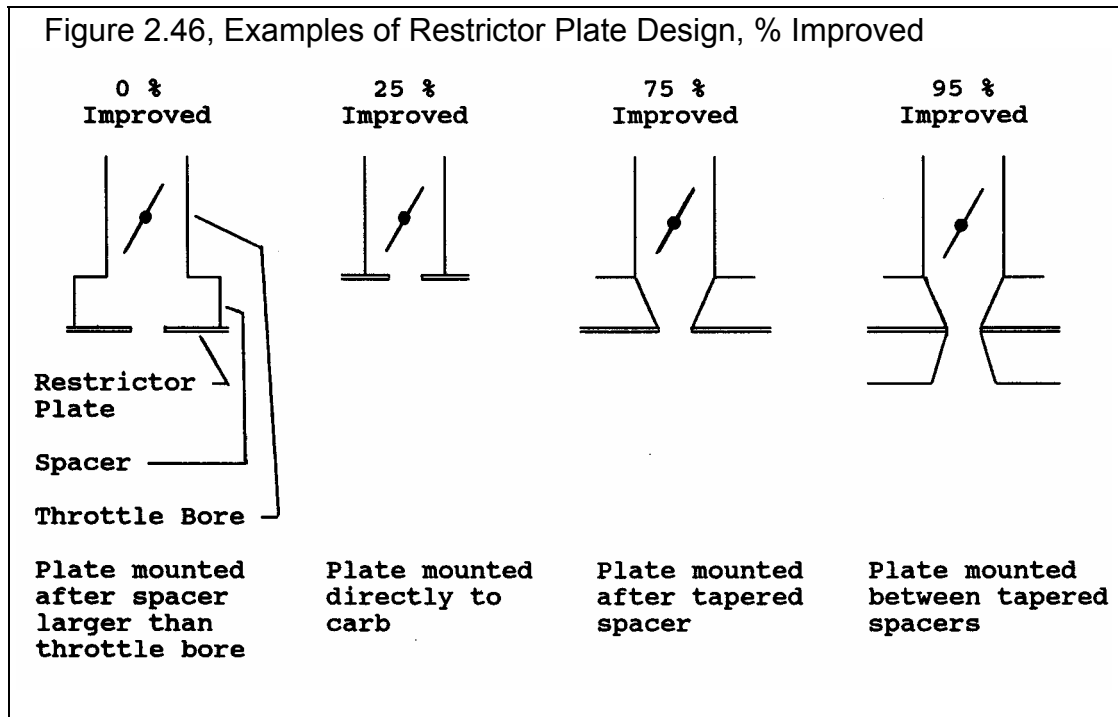

2.9.9.2 Calc CFM Flow Rating

Is the CFM Flow Rating calculated from flow bench data.

Note: Since this calculation is based on flow data for the actual carburetor or throttle body, this is the most accurate method of determining CFM Flow Rating. If the value you obtain here is significantly different than the manufacturer's CFM rating at 1.5" Hg, double check your flow data. The manufacturer's CFM rating should not be more than 15% different, unless you have made modifications to the carb.

Flow Bench Data

Flow Bench Flow, CFM

The CFM recorded when flowing the carb or throttle body on the flow bench.

Bench Test Pres, " water

The test pressure when flowing the carb or throttle body on the flow bench. This is usually 10, 12, 20, 25 or 28 inches of water. If you flow at 20.4" of water, you are flowing at 1.5" Hg and the CFM you record is the carb's CFM Flow Rating.

% Carb Flowed

Choices in this combo box let you describes if these flow numbers represent the engine's total carburetor or throttle body flow area. For example:

- If you flowed 1 4BBL carb and the engine is run with this 1 4BBL, you would choose 100%. These flow numbers represent the engine's entire carburetor flow.
- If you flowed 1 4BBL carb, but the engine is run with dual 4BBLs, you would choose 50%, since the test CFM for 1 4BBL only represents half of the engine's carburetors.
- Assume you have a small flow bench and a Quadra-Jet carb. If you flow the entire carb, the test pressure is quite low. However if you block off 1 secondary and 1 primary, the test pressure increases up to 6 "water. You record 202 CFM for this condition. You would enter 6 for Bench Test Pres, 202 for Flow Bench Flow and choose 50% for % Carb Flowed.

Note: This specs says % *Carb* flowed but it is equally accurate to estimating the CFM Flow Rating of a throttle body system.

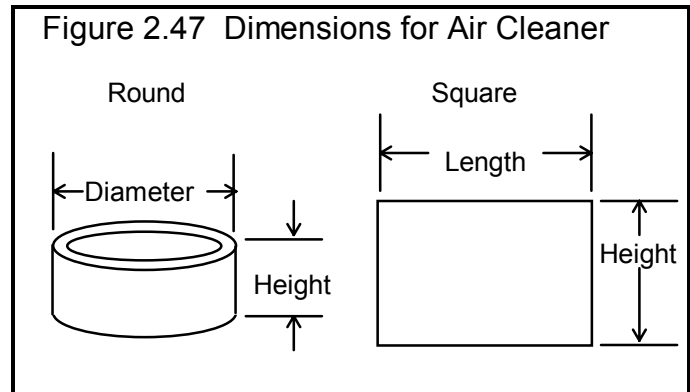

2.9.10 Calc Air Cleaner CFM

Is the Air Cleaner CFM rating calculated from the following specs in CFM at 3 "water pressure drop. Air Cleaner CFM rating is defined on page 30 under Intake System specs. See page 97 for general notes on Calculation Menus and for an example of their use.

Air Cleaner Shape

This combo box lets you pick the general shape of the air cleaner element:

- No Air Cleaner
- Round(cylinder) as shown in Figure 2.42
- Square (flat) a flat, rectangular element, typical of modern fuel injected engines

Diameter, in or Width, in

If you select Round as the Shape, this spec will be marked Diameter. If you selected Square as the Shape, this spec will be marked Width. Enter the appropriate dimension as shown in Figure 2.47 in inches.

Height, in

Is the height dimension as pictured in Figure 2.47, in inches.

Note: If the engine is equipped with 2 air cleaners of this certain size, in parallel (half the air goes through 1 filter and half through the other) double this dimension. If the engine has 2 air cleaners of this size, in series (all air goes through 1 filter and then again through the other) cut this dimension in half.

Element Type

Pick the appropriate element type from this combo box, Paper or Foam.

Note: Foam is not always lower restriction than paper. Depending on manufacturer, OEM paper elements may actually be less restrictive than aftermarket paper or foam elements. However, this calculation always assumes Foam is less restrictive.

Silencing 'Snorkel'

Most production air cleaner housings have some type of "venturi" restriction for reducing intake noise. Choose Yes for these type of air cleaners. Choose No for most all types of performance, aftermarket air cleaners where the element is well exposed.

2.9.11 Calc Plenum Vol, cu in

Is the Plenum Volume calculated from the following specs in cubic inches. Plenum Volume is defined on page 30 under Intake System specs. See page 97 for general notes on Calculation Menus and for an example of their use.

Plenum Specs

Calculation Type

This combo box lets you pick how the calculation should be made, either

- Dimensions like height, width, depth, etc.
- % Engine Displacement like a percent of the engine's cubic inches

Your choice here will determine which specs are enabled or disabled in this menu.

Shape

If you select Dimensions for the Calculation Type, this combo box lets you pick the general shape of the plenum when view from the front of the engine:

- Rectangular
- Rounded Rectangular
- Oval
- V-Bottom

See Figure 2.48 for examples.

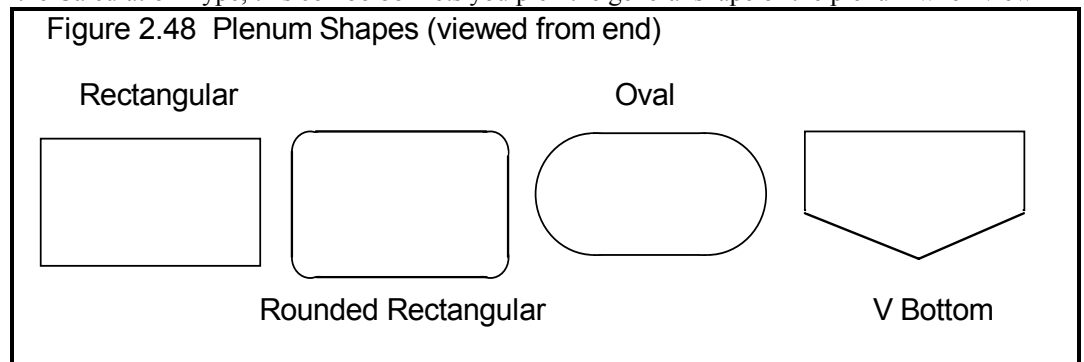

Length, in

If you select Dimensions for the Calculation Type, this dimension represents the length of the plenum. See Figure 2.49.

Width, in

If you select Dimensions for the Calculation Type, this dimension represents the width of the plenum. See Figure 2.49.

Depth, in

If you select Dimensions for the Calculation Type, this dimension represents the depth of the plenum. See Figure 2.49.

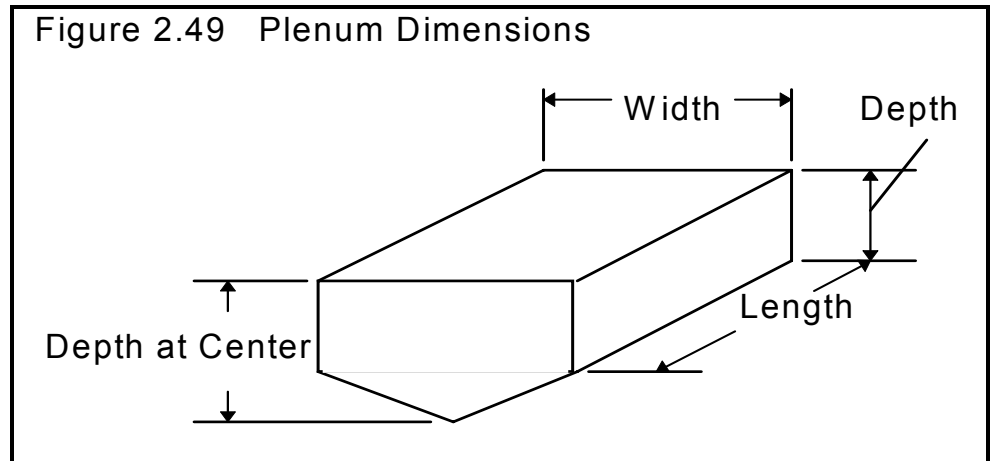

Depth in Center, in

If you select Dimensions for the Calculation Type and V Bottom for Shape, this dimension represents the depth at the center of the plenum. See Figure 2.49.

Fraction Eng Disp

If you do not have exact dimensions of the plenum or the plenum is complicated to measure, you can *estimate* the plenum size as a percent of the engine's displacement. If you select % Displacement for the Calculation Type, choose the appropriate % rating from this combo box.

2.9.12 Calc Carb Area, sq in or Calc Throttle Body Area, sq in

Is the Total Carb or Total Throttle Body area calculated from the following specs in square inches. Total Carb Area or Total Throttle Body Area are defined on page 31 under Intake System specs. See page 97 for general notes on Calculation Menus and for an example of their use.

If most of the ducting before or after the throttle plates is larger or smaller than the throttle plate itself, increase or decrease the throttle diameters to show this more true diameter of entire duct.

Know

This combo box lets you pick how the calculation should be made, either from:

- 4 Barrel CFM Rating like a 600 CFM carb (this is usually easier but is more of an estimate)
- Dimensions like throttle plate size, number of throttle planes, etc.

CFM Rating CFM *

This is the Total CFM rating for all throttle plates on the engine, either Carbs or Throttle Bodies. This spec is enabled only if you said you Know 4 Barrel CFM Rating. This spec is initially set to the Total CFM Rating from the Intake Specs menu, but you can change it to any value you want. Be sure to use a **4 Barrel CFM Rating** which means it was tested at 1.5" mercury pressure drop (20.4" water). Use this conversion to convert from a 2 barrel CFM rating:

$$4 \text{ Barrel CFM} = 2 \text{ Barrel CFM} \times .71$$

For example, a 350 CFM 2 barrel would give a $350 \times .71 = 249$ CFM 4 barrel rating.

Total # Pri. Throttle Plates

The total # of primary barrels. For a single 4 barrel carburetor, this would be 2, for three 2 barrel carbs this would be 2. This spec is enabled only if you said you Know Dimensions.

Primary Throttle Dia, in

The diameter of the throttle opening or throttle butterfly plate for the Throttle Plates, not venturi diameter. This spec is enabled only if you said you Know Dimensions.

Total # Sec. Throttle Plates

The total # of secondary barrels. For a single 4 barrel carburetor, this would be 2, for three 2 barrel carbs this would be 4. This spec is enabled only if you said you Know Dimensions.

Secondary Throttle Dia, in

The diameter of the throttle opening or throttle butterfly plate for the Sec Throttle Plates, not venturi diameter. If Total # Secondary Throttle Plates is set to 0 or you said you Know 4 Barrel CFM Rating, this value is disabled (dimmed to gray) and ignored.

Note: Primary throttles and secondary throttles are not treated differently in this calculation menu. The only reason they are listed separately here is to easily handle throttle plates which are different sizes. For example, if the primary and secondary throttles were the same size in the three 2 barrel examples above, you could have used 6 Pri Throttles, 0 Sec Throttles and arrived at the same answer.

2.9.13 Calc Venturi CD

Is the Venturi Discharge Coef (CD) calculated the from following specs. Venturi Discharge Coef is defined on page 34 under Intake System specs. See page 97 for general notes on Calculation Menus and for an example of their use.

Main Venturi Dia, in

The diameter of the main venturi (not the smaller booster venturi) for the carb bore being flowed, in inches.

Main Venturi Flow; CFM

The air flow being drawn through the venturi being tested in CFM. The basic procedure for this test includes:

- Block off all carb throttle bores except the one to be flowed. Be sure to block off all other fuel and air metering passages in the carb.
- Flow this one throttle bore with the throttle plate at full open.
- Set a test pressure similar to that "seen" by the engine at the HP peak, but not less than 8" water. For example, if the engine will be equipped with 1 4BBL, and the Engine Analyzer Pro predicts 1" mercury Intake Vac at the HP peak, set approximately 1" mercury (13.6 " water) test pressure. (Multiply " mercury by 13.6 to obtain " water.)
- Measure the Booster Signal vacuum produced by the main venturi and booster venturi combination in "water. This is done by attaching a manometer line to the main metering jet. For accurate readings, the power valve flow channel and air bleed should be blocked.

If the carb and test work properly, you should be able to record sets of different Venturi Flows (from different test pressures) and Booster Signals. Each set should produce approximately the same Calc Venturi CD when entered into this menu.

Booster Signal, " water

Is the venturi vacuum measured at the main metering jet, in inches of water.

2.9.14 Calc Exh Sys CFM Rating

Is the Exhaust/Muffler System CFM Rating calculated from the following specs. Exhaust/Muffler System CFM Rating is defined on page 37 under Exhaust System specs. See page 97 for general notes on Calculation Menus and for an example of their use.

Note: The CFM Rating calculated in this menu is a very approximate estimate. That is because both inputs are vague and open to interpretation. For that reason, please read Exhaust/Muffler System CFM Rating starting on page 37 for alternate methods to estimate this value.

Engine HP

The rated horsepower output of the engine for which the exhaust system was originally designed. This defines the approximate amount of exhaust flow the system was designed to handle.

Type of Vehicle

Describes the application for which the exhaust system was originally designed. This defines the approximate amount of backpressure the exhaust system was designed to produce.

- Full Race is an exhaust system with extremely low back pressure, designed for classes of racing where rules require mufflers.
- Aftermarket is an exhaust system with very low back pressure, but still quiet enough for the street (as long as you do not go full throttle).
- Prod Sporty is a production exhaust system for performance and sports cars which must pass full power noise standards.
- Prod Quiet is a production exhaust system for a family sedan or luxury sedan where a "throaty" engine roar is undesirable.

2.9.15 Calc Collector Dia, in

Is the Collector Dia calculated from the following specs. Collector Dia is defined on page 39 under Exhaust System specs. See page 97 for general notes on Calculation Menus and for an example of their use.

Header Specs

Primary Pipe Dia, in

Is the inside diameter of the primary headers pipes where they enter the collector in inches. If you have specified Tapered or Stepped pipes, this is the Inside Dia at Exit diameter from the Exhaust System menu. This value is initially set to the appropriate diameter from the Exhaust System menu, either Inside Dia at Head or Inside Dia at Exit, but you can change it to anything you wish.

Pri. Pipes/Collector

This spec is based on the Short Block spec '# Cylinders'. This is the arrangement assumed in the program's calculations and can not be changed. For example, if you specify # Cylinders greater than 5 cylinders; the program assumes half this # Cylinders primaries converge to the collector respectively. This spec is determined by the program and can not be changed.

You must enter the correct # Cylinders in the Short Block menu before using this calculation menu.

Area Change

This combo box lets you pick a percent change in the area of the entrance to the collector compared to the combined area of all the primary header pipes which enter the collector. For example, if you want the area of the collector to equal the area of the primary pipes at the collector, choose "No area change". If you want the area of the collector to be 20% greater than the combined area of pipes at the collector, choose "20 % more".

2.9.16 Calc Eff Valve Mass, gms

Is the Eff Valve Mass calculated from the following specs in grams. Eff Valve Mass is defined on page 47 under Cam/Valve Train specs. See page 97 for general notes on Calculation Menus and for an example of their use.

Valve Weight, gms

The weight of one valve in grams. Even if there are 2 or 3 intake or exhaust valves per cylinder, enter the weight of only 1 valve.

Retainer + Locks Wt, gms

The weight of one valve spring retainer and the locks or keepers which attach the retainer to the valve stem, in grams. Even if there are 2 or 3 intake or exhaust valves per cylinder, enter the weight of only 1 retainer and 1 set of locks.

Spring + Damper Weight, gms

The weight of all valve springs and "spring like" dampers for one valve in grams. Even if there are 2 or 3 intake or exhaust valves per cylinder, enter the weight of the valve springs for only 1 valve. (Do not enter weights for "cup type" dampers which do not move with the valve spring.)

Rocker Arm wo Fulcrum, gms

The weight of one rocker arm in grams. Do not include the weight of the fulcrum. The fulcrum is the non-rotating pivot the rocker arm rotates on.

2.9.17 Calc R.A. Stiffness

Is the Eff Rckr Arm Stffnss calculated from the following specs in pounds per inch. Eff Rckr Arm Stffnss is defined on page 47 under Cam/Valve Train specs. See page 97 for general notes on Calculation Menus and for an example of their use.

This calculation requires you to run a fairly sophisticated (and somewhat dangerous) test on the assembled engine. The test procedure includes:

- Removing (or dropping) the valve for the rocker arm you want to test.
- If you have hydraulic lifters, you must collapse the lifter (allow all the oil to leak out).
- Make up a fixture to apply a force at the rocker arm tip and install a dial indicator to measure rocker arm tip movement. See Figure 2.50.
- Zero the dial indicator with no force (no weights) applied.
- Apply 500-1000 lbs of force (50-100 lbs of weight) while measuring the rocker arm tip movement. Enter these readings in this menu. If the engine is mounted on an engine stand, be sure it can not spin or tip over during this process.
- Remove the force and check that the dial indicator returns to zero.

Safety Note: This test should only be attempted by qualified mechanics, machinists or engine builders taking the proper precautions.

Note: Accurate numbers are difficult and time consuming to obtain. Unless you are doing valve train analysis or valve train and cam design, it is recommended that you simply use estimates from Table 2.13, page 47.

Force on R.A. Tip, lbs

The total force applied to the rocker arm tip, in pounds.

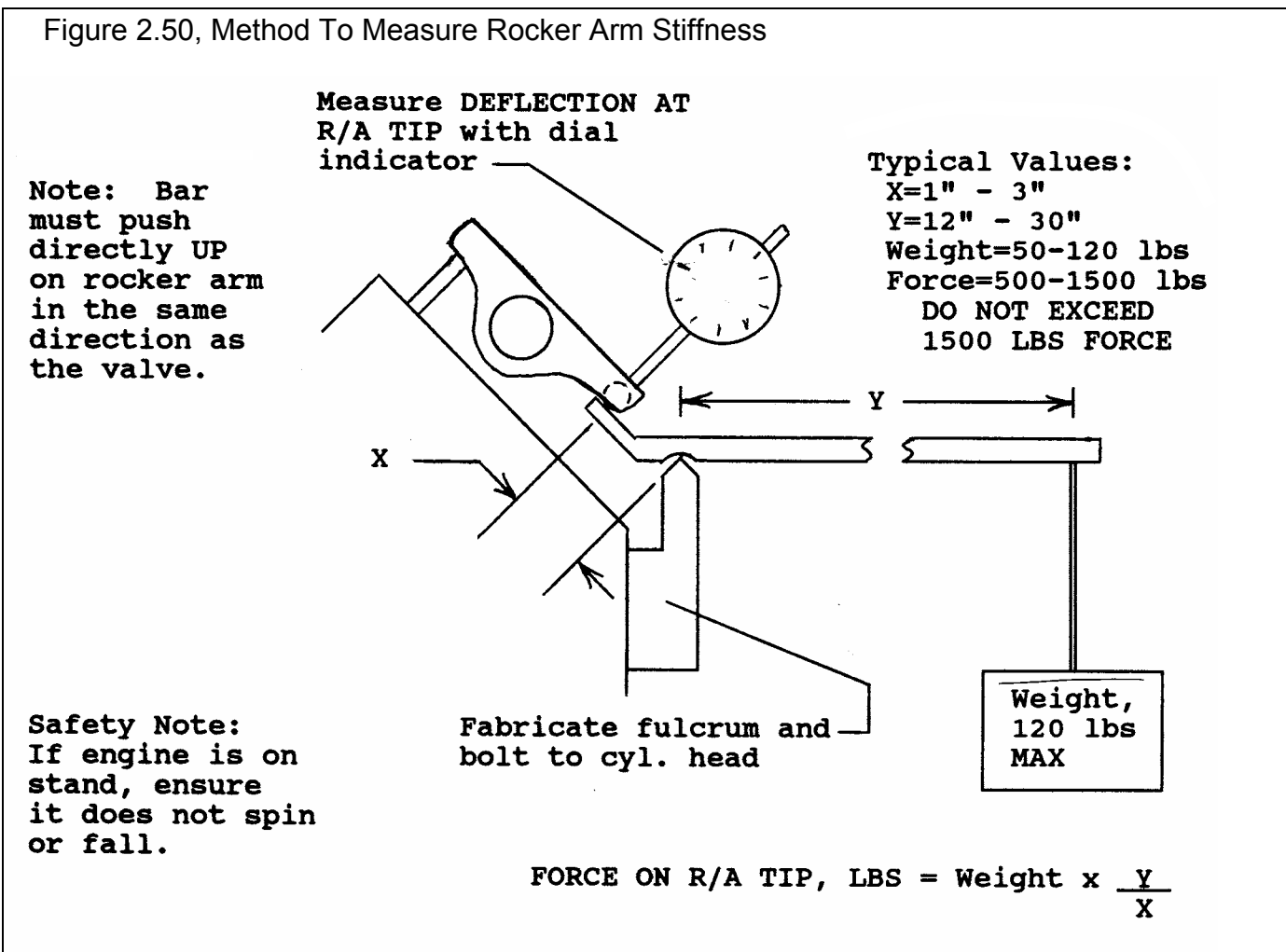

Deflection of R.A. Tip, in

The amount of movement of the rocker arm tip from the force applied, in inches.

2.9.18 Calc Eff Lifter Mass, gms

Is the Eff Lifter Mass calculated from the following specs in grams. Eff Lifter Mass is defined on page 48 under Cam/Valve Train specs. See page 97 for general notes on Calculation Menus and for an example of their use.

Pushrod, gms

The weight of one pushrod in grams.

Lifter, gms

The weight of the lifter, tappet or follower which "rides" on the cam lobe in gms.

Rocker Arm wo fulcrum, gms

The weight of one rocker arm in grams. Do not include the weight of the fulcrum. The fulcrum is the non-rotating pivot the rocker arm rotates on.

2.9.19 Calc Spring Rate, lb/in

Calc Seated Spring Force, lb

Are the Spring Rate and Seated Spring Force calculated from the following specs in pounds per inch and pounds respectively. Spring Rate and Seated Spring Force are defined on page 48 under Cam/Valve Train specs. See page 97 for general notes on Calculation Menus and for an example of their use.

Since these 2 specs are so related, they are calculated at the same time from the same inputs.

Seated Spring Force, lbs

The force (sometimes called pressure) applied by the spring to hold the valve on its seat. This is also the force generated by the spring when it is compressed to its installed height. This force is stated directly as Calc Seated Spring Force.

Seated Spring Height, in

The compressed height of the valve spring when the valve is seated.

At One Other Lift

Spring Force, lbs

The force (sometimes called pressure) required to compress the valve spring to the Spring Height described below. In catalogs this would be called the "open force" or "open pressure".

Spring Height, in

The height of the valve spring when compressed approximately as much as at maximum valve lift. This would be a height somewhat before coil bind, with still .050" or more between coils. A common lift quoted in cam catalogs is the "open height".

The actual height is not critical as long as it is before coil bind occurs. However, the closer this lift is to the valve's max lift height or open height, the more likely to correct for any "non-linearity" in the spring.

2.9.20 Calc Belt Ratio

Is the Belt Ratio for either a Roots or Centrifugal supercharger calculated from the following specs. Belt Ratio is defined on page 52 and page 56 under Roots Supercharger and Centrifugal Supercharger specs. See page 97 for general notes on Calculation Menus and for an example of their use.

S/C Pulley Diameter, in

The diameter of the supercharger pulley measured in inches. This can also be the number of cogs on this pulley if you are using a cogged belt. Then you must also use # cogs for Crank Pulley Diameter, not inches.

Crank Pulley Diameter, in

The diameter of the crankshaft pulley which drives the supercharger measured in inches. This can also be the number of cogs on this pulley if you are using a cogged belt. Then you must also use # cogs for S/C Pulley Diameter, not inches.

2.9.21 Calc Island CFM

Is the turbocharger compressor Island CFM calculated from the following specs. Island CFM is defined on page 58 under Turbocharger specs. See page 97 for general notes on Calculation Menus and for an example of their use.

Occasionally, turbocharger compressor maps are given in units of mass flow like lb/min. For these cases, use this calculation menu to convert mass flow to volume flow in CFM.

Flow at Peak Eff, lb/min

The mass flow which gives peak thermal efficiency, in the middle of the efficiency "island". If mass flow is given in Kg/min, multiply by 2.2 to obtain pounds per minute.

Map Temperature, deg R

Compressor maps usually give the standard weather conditions (temperature and pressure) to which the data is corrected. Enter this standard temperature here, converted to degrees Rankine.

If this temperature is in	First Multiply by	Then Add
Degrees F	1	460
Degrees C	1.8	492
Degrees K	1.8	0
To obtain Degrees Rankine.		

If no temperature is given on the map, enter 520 degrees.

Map Barometer, "Hg

Compressor maps usually give the standard weather conditions (temperature and pressure) to which the data is corrected. Enter this standard barometric pressure here, converted to inches of Mercury.

If this pressure is in:	Multiply by:
PSI	2.036
Bar	29.52
mm Hg	.03937
To obtain " Hg.	

If no barometric pressure is given on the map, enter 29.92

2.9.22 Calc Turbine Nozzle Dia, in

Is the turbocharger Turbine Nozzle Dia calculated from the following specs in inches. Turbine Nozzle Dia is defined on page 60 under Turbocharger specs. See page 97 for general notes on Calculation Menus and for an example of their use.

Figure 2.51, Illustration of Turbocharger Turbine Dimensions

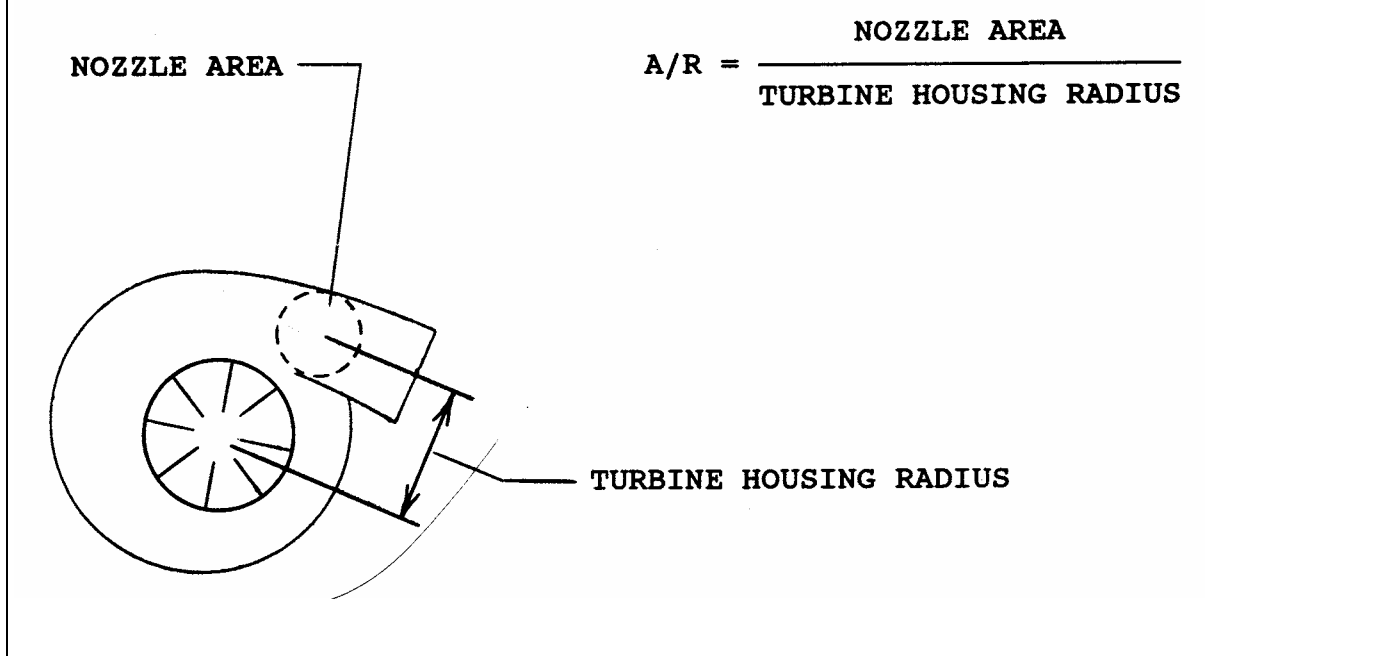

Est from Comp CFM

If you have no measurements or specs for the turbocharger turbine, choose Yes. Then enter the Compressor Island CFM that you will use as Island CFM in the Turbocharger Specs as the CFM @ Peak Eff in this calculation menu.

If you do have turbine specs or dimensions, choose No and adjust the Turbine Specs that follow.

CFM @ Peak Eff

Enter the Island CFM for the compressor as listed in the Turbocharger Specs. If you chose No for Est from Comp. CFM, this spec is disabled and this value is ignored in the calculation.

Turbine Specs

Spec to Use

This combo box lets you choose the type of dimensions you have for the exhaust turbine:

- A/R Ratio
- Area

Your choice here will determine which specs in this section of the menu are enabled

Turbine A/R

The turbine housing's A/R ratio. A/R ratio is illustrated in Figure 2.51.

If you chose Area for Spec to Use, this spec is disabled and its value is ignored in the calculation.

Housing Radius, in

The radius of the turbine housing as pictured in Figure 2.51, in inches.

If you chose Area for Spec to Use, this spec is disabled and its value is ignored in the calculation.

Nozzle Area, sq in

If you know the turbine nozzle flow area, enter it here in square inches. If you have area in sq cm, multiply by .155 to obtain square inches.

If you chose A/R for Spec to Use, this spec is disabled and its value is ignored in the calculation.

2.9.23 Notes on Barometric Pressure & Elevation

This menu simply displays the relationship between barometric pressure and elevation specifications, as explained in Section 2.8.1, page 63 and 64. Refer to that page for further details. Click on OK or press the <space bar> to return to the Calculation Conditions menu with no change to either Barometric Pressure or Elevation

2.9.24 Calc Dew Point, deg F

Is the Dew Point, Deg F calculated from the following specs. Dew Point, Deg F is defined on page 64 under Calculation Conditions specs. See page 97 for general notes on Calculation Menus and for an example of their use.

Know Relative Humidity

Your choice here will determine which specs are enabled in this menu.

Outside Air Temp, deg F

Is the outside air temperature when the relative humidity measurement was made. For example, if the weather service or weather report gives a relative humidity of 56 % and a temperature of 68 degrees, use 68 for the Outside Air Temp. If you chose No for Know Relative Humidity, this spec is disabled and its value is ignored in the calculation.

Outside Rel Humidity, %

Is the air's relative humidity as reported by a weather service or measured by humidity instruments. If you chose No for Know Relative Humidity, this spec is disabled and its value is ignored in the calculation.

Dry Bulb Temp, deg F

Is the temperature of the dry bulb thermometer on the psychrometer in degrees F. This is also the temperature of any thermometer mounted in the shade when the Wet Bulb Temp reading is taken. The Dry Bulb Temp must not be less than the Wet Bulb Temp. If you chose Yes for Know Relative Humidity, this spec is disabled and its value is ignored in the calculation.

Wet Bulb, deg F

Is the temperature of the wet bulb thermometer on the psychrometer in degrees F. The wet bulb has a "wick" or cloth covering the bulb which is moistened with water. The dryer the air, the greater the difference between the wet and dry bulb readings. Relative humidity or dew point can be manually read off a Psychrometric chart from these two readings. This calculation replaces reading the chart. The Wet Bulb Temp must be less than the Dry Bulb Temp. If you chose Yes for Know Relative Humidity, this spec is disabled and its value is ignored in the calculation.

Chapter 3 Output

The Engine Analyzer Pro provides several ways to view and output the test results, including:

- Tabular, calculated results displayed on the screen
- Tuning Pressures screen to watch port pressures and intake & exhaust flow while calculations are taking place
- Analysis Report giving tips, warning of safety issues, etc.
- ASCII files for importing results to other software packages
- High resolution graphs
- Printer output or reports or graphs
- Data Libraries for recording either test results or sets of engine specs for later use
- See-Engine screen to actual watch the piston and valves move and interact, tuning pressures, air flow, etc.

All these topics will be covered in this chapter. Figure 3.1 shows how to reach all these various features, except Tuning Pressures. This option must be selected while the calculations are taking place by clicking on the See Tuning Pressures button in the Progress Indicator box..

The Output features have been expanded in later versions. See Appendices 9 - 13 on pages 235-312 for more updated info.

Figure 3.1 Various Output Options from the Test Results Screen

Menu bar with output options: Back to Main Menu, Make Graphs, Print Results, Display Help, Save or Open Files of Test Results, Analyze results (program gives advice based on user requirements and current results), See Engine piston/valves/valve dynamics/air flows, etc.

Command buttons: Make Graphs, Print Results, Display or Edit Engine and Component Comments, Display Notes (safety issues, possible problems, etc.) about current test results

Summary of Notes (safety issues, possible problems, etc.)

Name of current Engine File

Name of current Test File

Performance Summary

RPM Data. Click on any cell in the grid for a Help definition of that particular piece of data.

Slide bar. Click and drag button to display all RPM test results.

Special Calculations. Results which do not change with RPM. Click on any result for a Help definition of that particular piece of data.

Slide bar. Click and drag button to display all Special Calculation test results.

Horizontal slide bar. Click and drag to display all RPM Data if # RPMs is greater than 12.

Engine RPM	1200	1600	2000	2400	2800	3200	3600	4000	4400	4800
Brk Tq, ft-lbs	259	268	272	272	273	284	283	278	270	253
Brake HP	59.2	81.6	104	124	145	173	194	212	226	231
Exh Pres, PSI	0.1	0.2	0.4	0.6	0.8	1.2	1.5	1.9	2.2	2.5
Int Vac, "Hg	0.2	0.3	0.6	0.8	1.2	0.5	0.6	0.8	0.9	1.1
Vol Eff, %	71.9	73.0	74.0	75.2	77.2	81.2	82.9	83.8	83.8	82.2
Actual CFM	75.3	102	129	157	189	227	260	293	322	344
Fuel Flow, lb/hr	26.3	35.6	45.1	55.0	65.9	79.2	91.0	102	112	120
Nitrous, lb/hr	0.0	0.0	0.0	0.0	0.0	0.0	0.0	0.0	0.0	0.0
Ntrs Fuel, lb/hr	0.0	0.0	0.0	0.0	0.0	0.0	0.0	0.0	0.0	0.0
BMEP, PSI	130	134	136	136	136	142	142	139	135	126
A/F Mxtr Qty, %	93.4	97.7	100.0	100.0	100.0	99.1	100.0	100.0	100.0	100.0
BSEC, lb/HP-hr	0.444	0.437	0.436	0.443	0.454	0.458	0.469	0.482	0.498	0.521

Valve Flow & Cam Calculations		--int--		--Exh--	
Overlap Area, deg*sq-in	0.8	Ulv Area, deg*sq-in	162.6	117.8	
Total Exh/Int %	72.5	Total Avg Flow Coef	0.249	0.272	
Lobe Separation, deg	115.0	Lobe Area, inch*deg	19.82	19.82	
Overlap, deg	34	Duration, deg	262	262	
		Opening Events, deg	15	63	
		Closing Events, deg	67	19	
Overlap @.050, deg	-28	Duration @.050, deg	202	202	
		Opn Evnts @.050, deg	-15	35	
		Cls Evnts @.050, deg	37	-13	
		Duration @.200, deg	108	108	

3.1 Tuning Pressures

The Tuning Pressures screen displays intake and exhaust port pressures and velocities. This screen is very useful for analyzing intake and exhaust tuning dynamics. Many users may not feel comfortable reading graphs. Therefore, the Pro also provides a small engine diagram to help give a feel for what the graphs mean. Main items of this screen are explained in Figure 3.2.

See Appendix 5: Watching Tuning Pressure and Flow for tips on interpreting these graphs.

Figure 3.2 Explanation of Tuning Pressures Screen

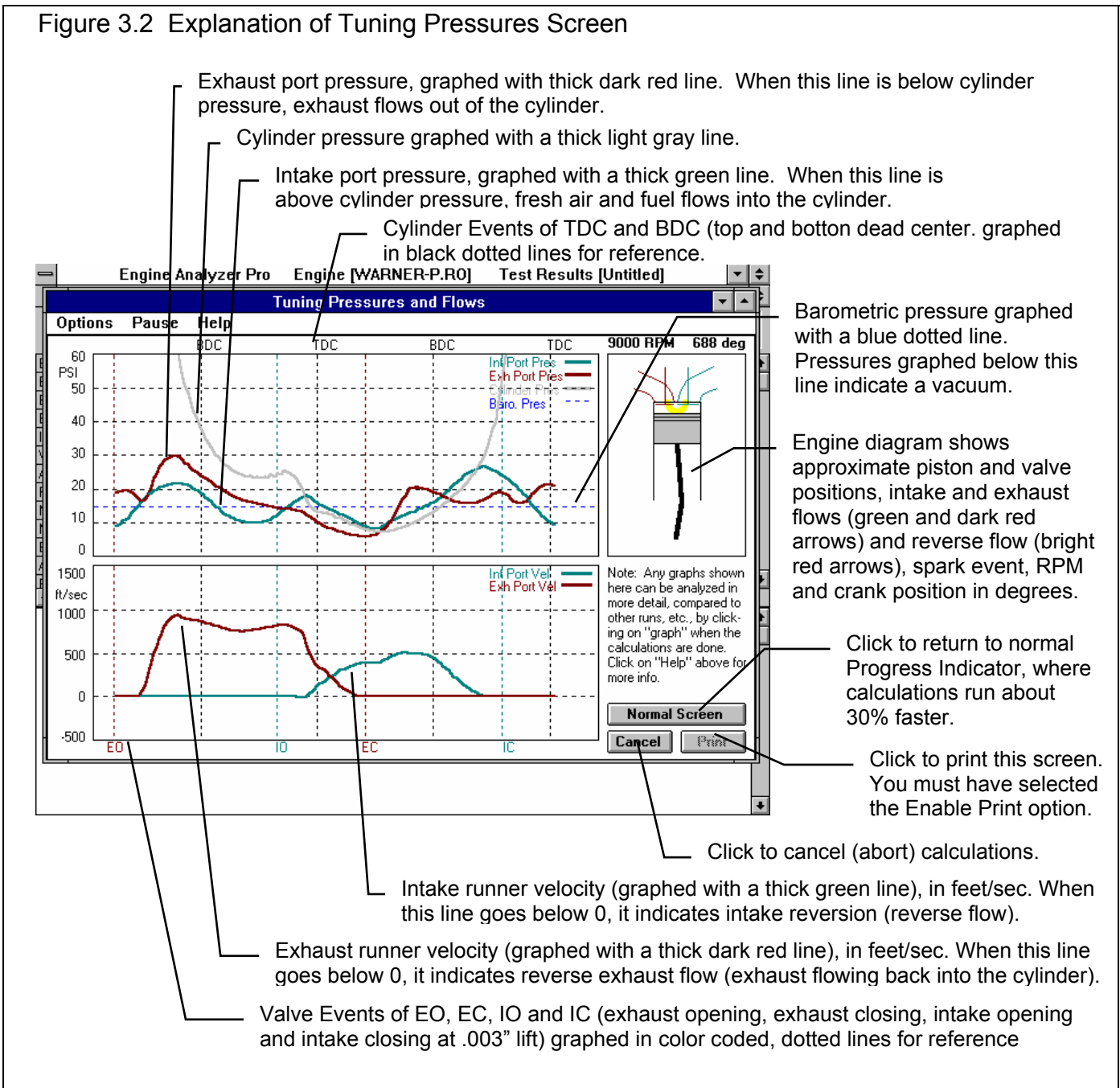

Options for Tuning Pressures

Click on the Options item in the menu line and the list of options shown in Figure 3.3 is displayed.

- Run Continuously
- Pause Each Cycle
- Pause Step

Your selection determines if the program waits for your action before continuing with the calculations. Run Continuously means the program does not stop. Pause Each Cycle means the program will stop at the end of 2 revs (one complete graph is drawn). Pause Each Step means the program stops every 4 degrees. Pausing is the most convenient way to print this graph at a particular point of completion.

When the program stops, a small menu appears with 3 choices:

- Continue
- Print (if the Enable Printing options has been chosen)
- Run Continuously (which turns off pausing)

- Normal Speed
- Slower Speed
- Slowest Speed

Changes the speed of the calculations and updating rate on this screen. Slower speeds make it easier to analyze particular portions of this graph.

- Show Velocity and Pressure
- Show Pressure Only
- Show Velocity Only

These options let you enlarge one section of this screen so items can be seen in greater detail. Show Velocity and Pressure is the option displayed in Figure 3.2.

- Show Entire Cycle
- Show Overlap Only

These options let you enlarge the overlap area of these graphs so items can be seen in greater detail. Overlap is the critical portion of the cycle as far and intake *and exhaust* tuning is concerned. This is where reversion and short-circuiting can occur. (Intake closing is also critical as far as intake tuning alone is concerned.) Show Entire Cycle is the option displayed in Figure 3.2.

- Enable Printing (slower/more flicker)
- Disable Printing

These options let you select to be able to print these Tuning Pressure graphs or not. If you select to Disable Printing, the calculations are a little faster and there is some less flicker in the Engine Diagram graphic.

Figure 3.3 Tuning Pressures Options

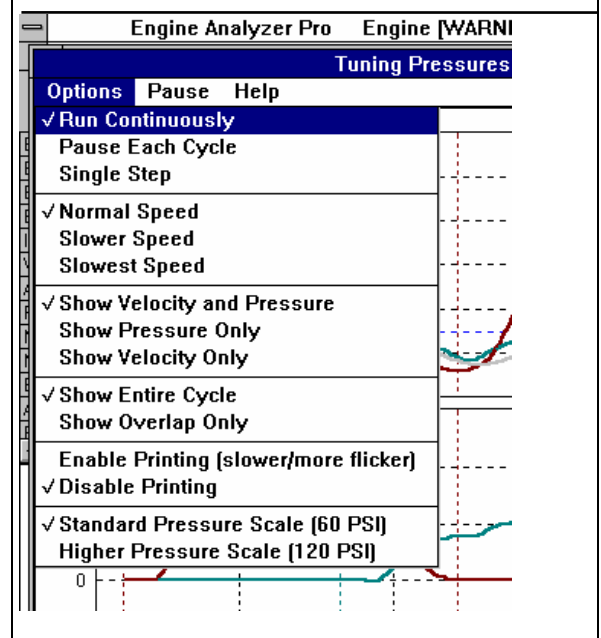

Standard Pressure Scale (60 PSI)
Higher Pressure Scale (120 PSI)

This option lets you graph port pressures either on a 0 to 60 PSI scale to show greater detail, or a 0-120 PSI scale. The 0-120 PSI scale is useful for graphing supercharged or turbocharged engines, where port pressures can go well over 60 PSI.

3.2 Analysis Reports

When calculated performance results are displayed on the screen, you can obtain the Analysis Options menu by clicking on Analyze in the menu bar. See Figure 3.4A.

The Analysis report consists of 2-5 pages of suggestions for improving performance, *safety warnings*, etc. concerning the performance results calculated. See Figure 3.4B for a screen report.

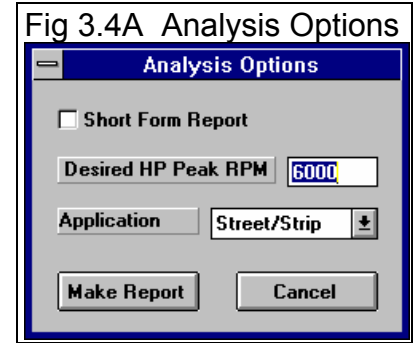

IMPORTANT: The ENGINE ANALYZER can NOT anticipate all UNSAFE and poor performing situations. Do NOT rely only on the Analysis report to point out problems and SAFETY HAZARDS. You must use your own judgment and expert advice by experienced engine builders and the manufacturer of the engine components.

Short Form

Check this Option box if you feel very comfortable with running the Engine Analyzer Pro and understanding its output. If you do not check this option you will obtain the full report which gives additional tips on changing the Engine Analyzer Pro inputs to obtain the desired performance level.

Desired HP Peak RPM

Enter the RPM where you would like this engine's HP to peak. The Analysis report will give suggestions for specifications to produce good performance at this RPM.

Application

Click this combo box for the following choices:

- Mild Street An engine driven primarily on the street. It must idle well, run a low RPM, and have a full exhaust system.
- Street/Strip An engine designed for occasional racing but must be durable and driven on the street.
- Full Race An engine designed for racing only. Since there are several classes of racing, from circle track "claimer" and "restricted" classes to Formula 1, the Analysis report does not get extremely specific.

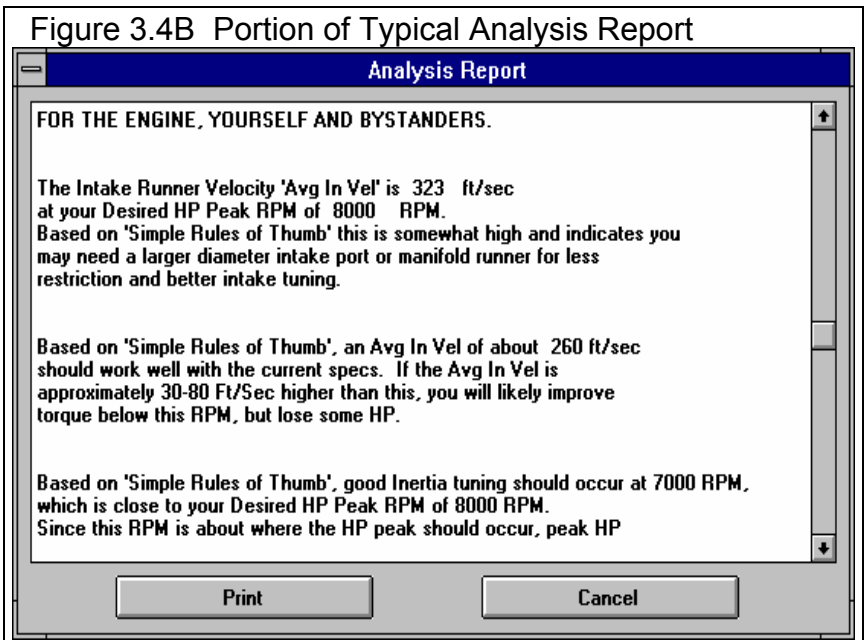

3.3 ASCII Data Files

The ASCII Data Files Features have been greatly expanded in later versions. See Appendices 9 - 13 on pages 235-312 for more updated info.

You may want to use the results from the Engine Analyzer Pro in other software packages. This could be for additional plot capabilities, statistical analysis, data basing, etc. Click on File, then select the Save Current Test Results to ASCII File to write the results to an ASCII file with a name of your choosing. This command is possible any time tabular, calculated results are displayed on the screen.

You can only save the results for the results currently displayed on the Test Results screen. If you want to write an ASCII file of test results you have previously run and saved, you must retrieve them first. This is done by clicking on File at the Test Results screen, then choose one of the "Pick" commands to retrieve these results so they are the Current Test results.

Performance data are the calculated results which appear on the screen, consisting of the RPM, Brk Tq, Brake HP, etc. Cycle data consists of the most recent Cycle plot data which was saved for this performance calculation. Examples of Cycle Data would be cylinder pressure and cylinder temperature versus crank degrees.

Figure 3.5 Options Menu for Writing ASCII Files

Some of these options are to let you save the data in different formats, to be compatible with the particular program which will read the file. Watch the Preview to see their effect.

Click on the data types to highlight them to indicate you want to write them to the ASCII File. Click on them again to "de-select" them. Many times it is more convenient to write all the data to the file and let the receiving program choose only the data to use. Then it is best to check the Output all Data option and all Data Types will be selected. Check or uncheck the Cycle Data (vs RPM Data) option to change the Data Types to choose from.

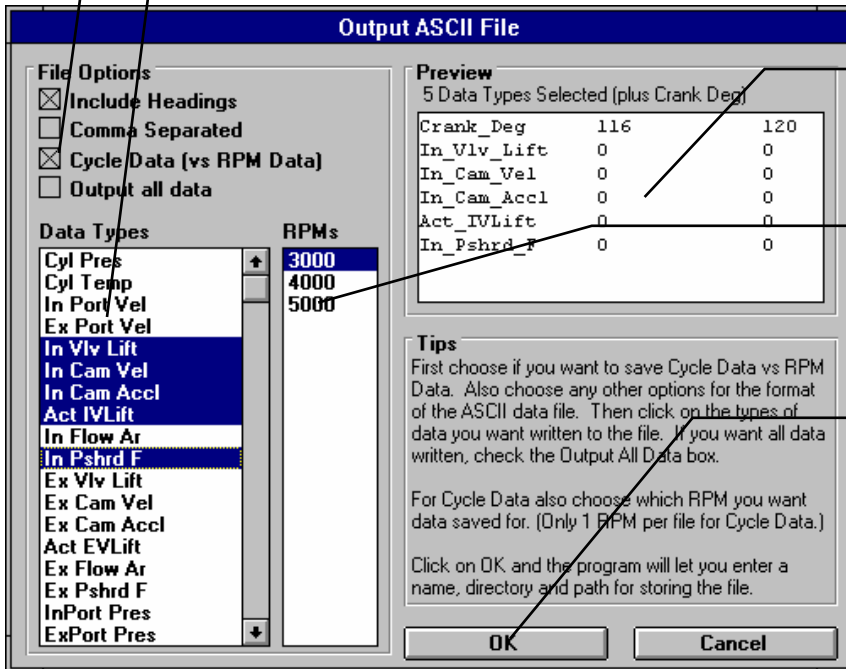

The preview shows what the upper left corner of the ASCII file will look like based on the options checked.

Click on the RPM for writing Cycle Data. Only 1 RPM's data written per ASCII file. This column is empty and not used for RPM data.

When ready (preview looks like you want the file format to look), click on OK. You will be presented with the standard Windows file saving menu to save the ASCII file to most any name, path, directory or drive.

3.4 Graphs

Graphs are obtained by clicking on the Graph button or the Graph name in the menu bar as shown in Figure 3.1. Figure 3.6 shows a typical graph and a descriptions of some of the basic graph screen items.

The Graphing Features have been greatly expanded in later versions. See Appendices 9 - 13 on pages 235-312 for more updated info.

Figure 3.6 Basic Graph Screen Items

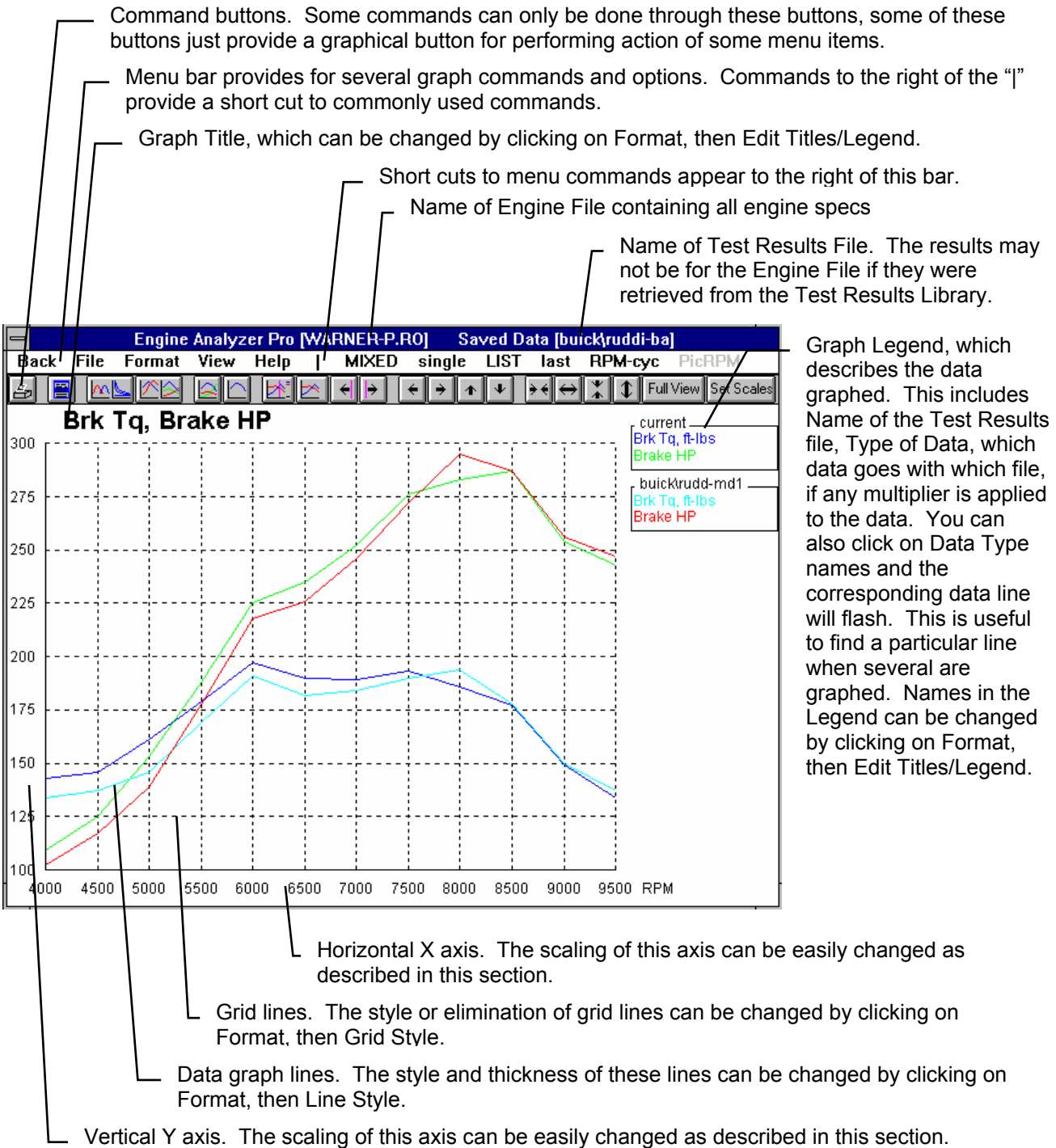

There are 2 basic types of *test data* which can be graphed:

- **RPM Data** like Brk Torque, Brake HP, etc. vs RPM.
- **Cycle Data** like cylinder pressure, intake runner flow velocity, intake valve flow area, etc. vs either crank degrees, time or cylinder volume

There are 2 basic types of *graphs*:

- **Single Data** graphs, where only 1 type of data is graphed. For example, this would be where Brake HP from 1 or several tests is graphed.
- **Mixed Data** graphs, where more than 1 type of data is graphed. For example, this would be where Brk Torque, Brake HP and Fuel Flow are graphed from 1 or several tests.

There are 3 basic types of *tests* which can be graphed:

- **Current test results.** These are the test results whose RPM data is displayed when at the Test Results screen. These can be for the test results just calculated, or for a test retrieved at the test results screen using the File menu command.
- **Last test results.** These are the test results from the previous calculation. By comparing the current calculated results to the last results, you can easily watch how each engine modification has effected performance. This is similar to the typical graph comparisons or version 1.1 and 1.2 or Engine Analyzer Pro.
- **Test results from the Common List.** The Common List is also the List of Commonly Used Test Files. This is a list of specially selected saved test results files, ones which may be of special interest or significance.

Note that you can not graph the data from saved test results file until that file has been added to the Common List. This is discussed later in this section.

RPM Data vs Cycle Data

You can switch between RPM Data and Cycle Data 2 basic ways as shown in Figure 3.7.

Figure 3.7 Switching between RPM Data and Cycle Data

Click on Format, then either Single Data Graphs or Mixed Data Graphs, then you will have a choice between RPM or Cycle Graphs as shown here.

Under the Format menu are buttons for switching between RPM and Cycle Data. Click on the left button shown to do Cycle Data, the right button switches to RPM data.

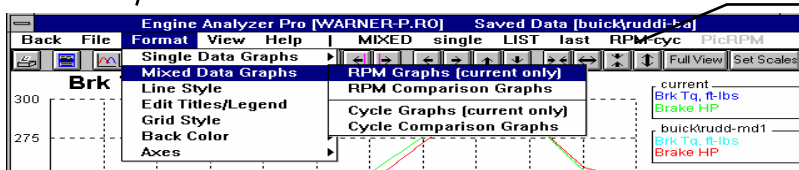
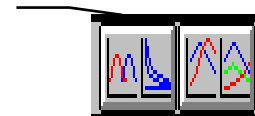

Click on the "RPM-cyc" menu item. Whichever data type "RPM" or "CYC" is given in upper case letters is the data type currently being used. In this case shown, clicking on "RPM-cyc" will switch the graph from the current RPM data type to the Cycle data type.

If you have selected Cycle Data, the program also needs to know for which RPM do you want the data graphed. Figure 3.8 shows how this is done. Figure 3.9 shows how to make Multi-RPM graphs. These are graphs where Cycle data from 2 or more RPMs from the current test are graphed for comparison. This can only be done if the current test is the only test being graphed (“last” and “list” must be turned off as discussed in a couple of pages).

Figure 3.8 Picking the RPMs for Graphing Cycle Data

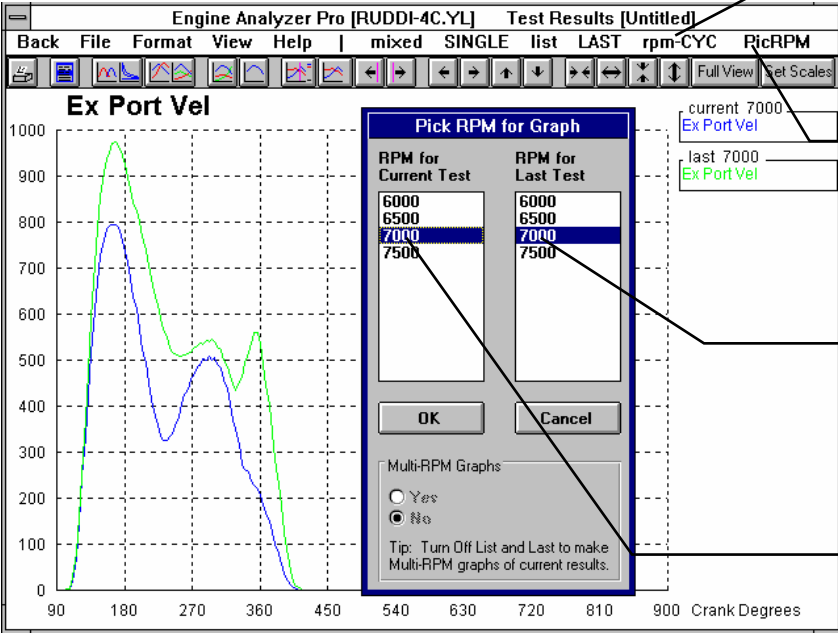

You must first select Cycle data by clicking on “rpm-CYC”

Click on PicRPM to display the Pick RPM for Graph menu. This menu option is enabled only when Cycle Data has been selected (rpm-CYC is the heading.)

If you have selected to graph data from the last test also (LAST is printed in upper case in the menu bar), you can also select the RPM for its data to graph.

Click on the one RPM for graphing Cycle data from the current test

Figure 3.9 Multi-RPM Cycle Graphs

“Last” and “list” must be turned off (printed in lower case) to do Multi-RPM graphs.

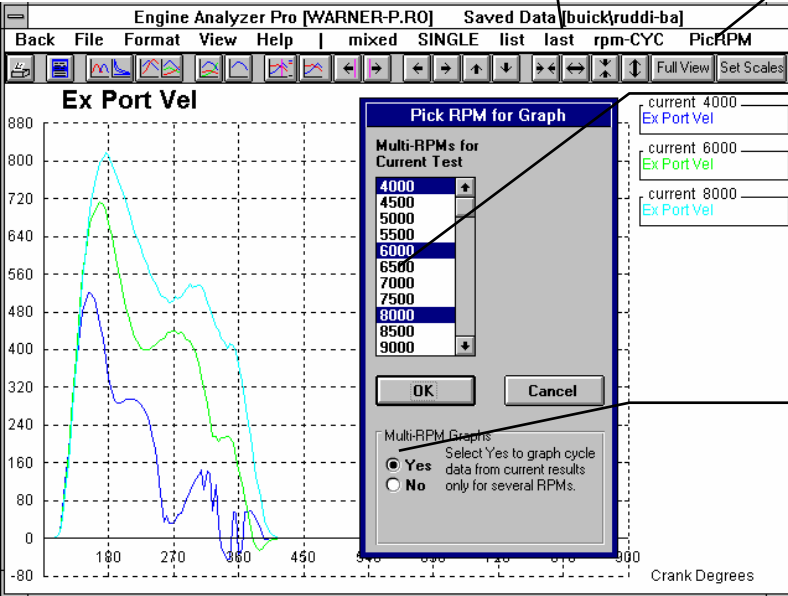

Click on PicRPM to display the Pick RPM for Graph menu.

For Multi-RPM graphs, click on as many of these RPMs as you wish and data for each will be graphed.

This screen shows a Multi-RPM Graph of a Single Data type, but Multi-RPM Graphs can also be made of Mixed Data types.

Click on Yes for the Multi-RPM Graph option. This option will be enabled only if “list” and “last” are turned off (printed in lower case).

Mixed Data Graph vs Single Data Graph

Figure 3.10 shows how to switch between these graph types. Figure 3.11 shows an example of a Single Data Graph of Cycle Data (intake port pressure) with explanations of some Single Graph features. Figure 3.12 explains the menu for producing Mixed Data graphs.

Figure 3.10 Switching between Mixed Data Graph and Single Data Graph Types

Click on Format, then either Single Data Graphs or Mixed Data Graphs, then you will have a choice between RPM or Cycle Graphs as shown here.

Click on the MIXED or SINGLE menu items. Whichever graph type is given in upper case letters is the graph type currently being used. In this case shown, MIXED is the graph type currently being used (torque and HP vs RPM).

Hidden under the Format menu are 2 buttons shown below. Click on the left button for Mixed Data Graphs and on the right one for Single Data Graphs.

Figure 3.11 Cycle Data Shown in Single Data Graph

Click on Data Type you want graphed, then click on OK (or simply double click on Data Type).

Click and drag the slide bar button to display all the data types.

For Cycle Data graphs, choose what you want graphed on the X Axis.

Figure 3.12 Menu of Mixed Data Options

Click here to use Saved (pre-programmed) Graph Patterns as explained in Figure 3.11.

Click on this button to enable options on the right side of this menu. These options let you specify and quickly change the manner in which you can plot from 1 to 4 different types of data on 1 graph.

Click on this combo box to pick the first type of data to include in the graph, or select "No Graph" to eliminate this particular graph line. These choices change depending on if you are making RPM or Cycle graphs.

Click on this combo box to pick the multiplier for the first graph line. A multiplier lets data of very different values appear with equal detail on the same graph. Note that the multiplier for Brk Tq and HP are both 1 since Brk Tq and Brake HP are usually about the same value (typically if torque is about 50, HP is from 30 to 100 HP, if torque is 500, HP is from 300 to 1000.)

Note that the multiplier for BSFC is 1000, or that you would have to multiply BSFC (typically in the range of .4 to .7) by 1000 to get a number approximately of the same magnitude as torque and HP.

If you are making Cycle Data graphs, you can pick the units for the X axis, either Crank Degrees (used the most often) or time in seconds or cylinder volume (primarily for pressure-volume diagrams).

The Guess at Multipliers has not yet been activated at the time of printing this manual. When activated it will have the program pick the multipliers so you don't have to.

Click here and the program will save this particular set of Data Types, Multipliers (and if Cycle Data, X Axis Data Type) under a name you will supply. This Saved Graph Pattern will appear in the list on the left side of this menu as shown in Figure 3.13.

Click here to produce the plot based on the current specs in the New Graph Pattern section.

Mixed Data Graph Format

Use Saved Graph Pattern | **Use New Graph Pattern**

Saved Graph Patterns

- RFMName: .k1.k
- 1) Brk Tq, ft-lb
- 2) Brake HP
- 3) No Plot
- 4) No Plot vs RPM

Delete

Torque & HP vs RPM
fdalk:ds'
.k.k.k

Build New Graph Pattern

Graph 1: Brk Tq, ft-lbs
Graph 1 Multiplier: 1 no effect

Graph 2: Brake HP
Graph 2 Multiplier: 1 no effect

Graph 3: BSFC, lb/HP-hr
Graph 3 Multiplier: 1000.

Graph 4: No Plot
Graph 4 Multiplier: 1 no effect

X Axis Type: RPM

Guess at Multipliers
 Use Multipliers Specified

Save This Graph Pattern

OK | Help

Figure 3.13 Menu of Mixed Data Options for Graph Patterns

The screenshot shows the 'Mixed Data Graph Format' dialog box. It is divided into two main sections: 'Use Saved Graph Pattern' on the left and 'Use New Graph Pattern' on the right. The 'Use Saved Graph Pattern' section includes a 'Current Pattern Chosen' list with items like '1) Brk Tq, ft-lbs' and '2) Brake HP', and a 'Graph Choices' list with 'Tq, HP & BSFC' highlighted. The 'Use New Graph Pattern' section is titled 'Build New Graph Pattern' and contains four graph configuration rows (Graph 1 to Graph 4), each with a name field (e.g., 'Brk Tq, ft-lbs'), a multiplier field (e.g., '1 no effect'), and a 'Delete' button. Below these are 'X Axis Type' (set to 'RPM') and radio buttons for 'Guess at Multipliers' and 'Use Multipliers Specified'. At the bottom are 'OK', 'Help', and 'Save This Graph Pattern' buttons. Annotations with arrows point from text on the right to these specific elements.

The left side of this menu is for picking pre-programmed graph patterns (either loaded at the factory or that you have created). Click on the Use Saved Graph Pattern button to enable these options.

A Graph Pattern consists of a set of all specs listed under the Use New Graph Pattern button

This section gives a summary of the graph pattern selected (highlighted) from the list below it.

Click on this button to delete the pre-programmed graph pattern which is currently selected (highlighted).

Click on the name of a particular pre-programmed graph pattern here.

Click on OK to make the graph based on the Saved Graph Pattern chosen.

Current Test Results, Last Test Results and Test Results from the Common List

Here's the definitions as given earlier:

- **Current test results.** These are the test results whose RPM data is displayed when at the Test Results screen. These can be for the test results just calculated, or for a test retrieved at the test results screen using the File menu command.
- **Last test results.** These are the test results from the previous calculation. By comparing the current calculated results to the last results, you can easily watch how each engine modification has effected performance. This is similar to the typical graph comparisons or version 1.1 and 1.2 of Engine Analyzer Pro.
- **Test results from the Common List.** The Common List is also the List of Commonly Used Test Files. This is a list of specially selected saved test results files, ones which may be of special interest or significance.

Note that you can not graph the data from saved test results file until that file has been added to the Common List. This is discussed later in this section.

The first 2 types are relatively self explanatory, the last of Test Results from Common List is explained in more detail in this section.

Figure 3.14 Picking Test Results to Graph

Clicking on the Common List button is the same as clicking on the LIST menu command.

Click on File, then on the Pick Test(s) from Common List. The other 3 options before Pick Test(s) from Common List let you manipulate files of Saved Test Results. These are explained in Section 3.6, Libraries.

Click on LIST to display the Common List or List of Commonly Used Files. This automatically turns off LAST if the graph had included the last calculated results. LIST is now printed in upper case and last is printed in lower case.

Click on LAST to have the graph include the last calculated results. This automatically turns off LIST if the graph had included the files from the Common List. LAST is now printed in upper case and list is printed in lower case.

Note: Click on LAST or LIST, whichever is upper case to turn that data off and only the current results will be graphed.

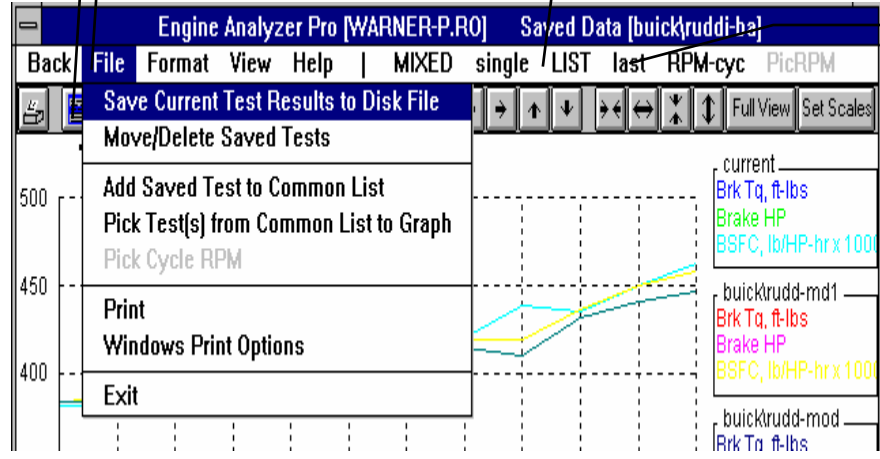
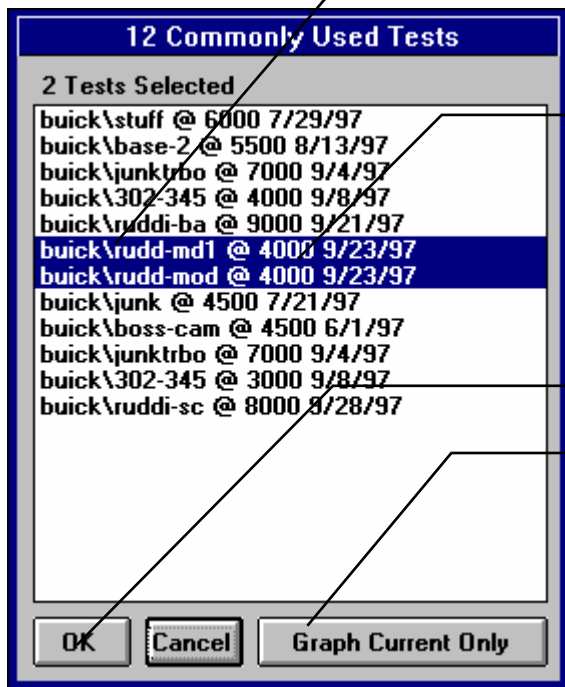

Figure 3.15 Common List



File Path	RPM	Date
buick\stuff	6000	7/29/97
buick\base-2	5500	8/13/97
buick\junktrbo	7000	9/4/97
buick\302-345	4000	9/8/97
buick\ruddi-ba	9000	9/21/97
buick\rudd-md1	4000	9/23/97
buick\rudd-mod	4000	9/23/97
buick\junk	4500	7/21/97
buick\boss-cam	4500	6/1/97
buick\junktrbo	7000	9/4/97
buick\302-345	3000	9/8/97
buick\ruddi-sc	8000	8/28/97

Click on the Saved Test Results to highlight it to include it in the graph. Click again on a highlighted test to “de-select” it. Then click on OK to make the graph.

The RPMs given with the Saved Test Results name is the RPM for the Cycle Data from this test which will be graphed. This RPM is not used if you are doing RPM graphs. If this is not the RPM you want to graph, you must click on File, then Add Saved Test to Common List, then add this file to the list again, this time picking the RPM you want to graph. A Test Results File can be listed more than once in the Common List.

Click on OK to make the graph.

Click here to omit graphing files from this list. This will produce a graph of only the current results.

Other Graphing Features

The graph screen has several features, including:

- Printing
- Cursor to pinpoint the value of a particular point on the graph
- Changing titles and legend names
- Changing the scales

These are discussed in this next section.

Printing

Figure 3.16 shows the options for printing graphs and how to access these options. Figure 3.17 shows the screen for changing the Windows Printer Setup.

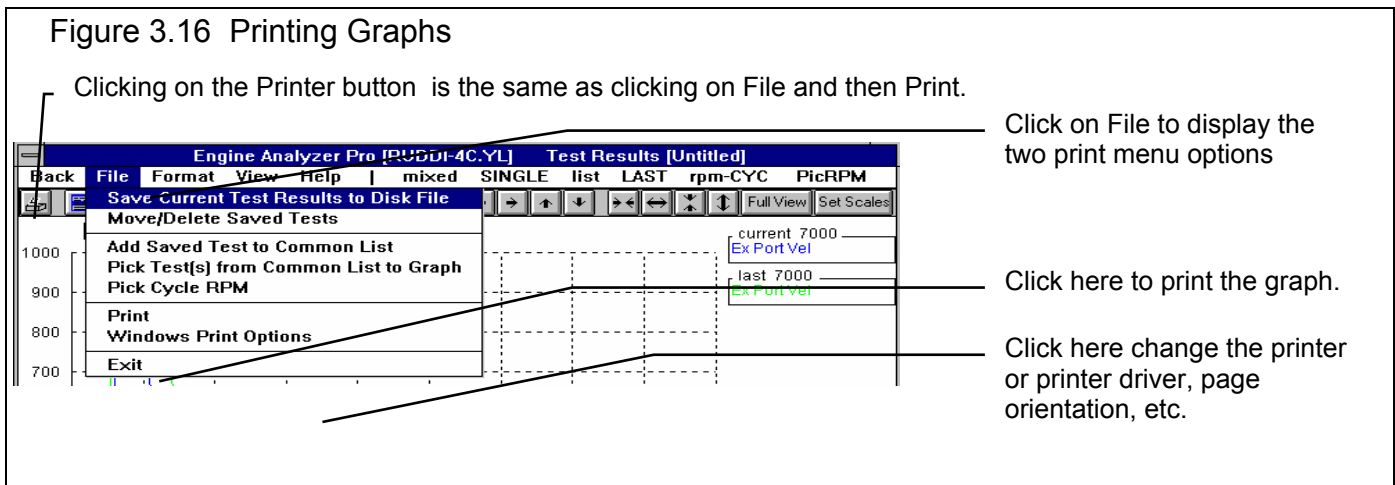
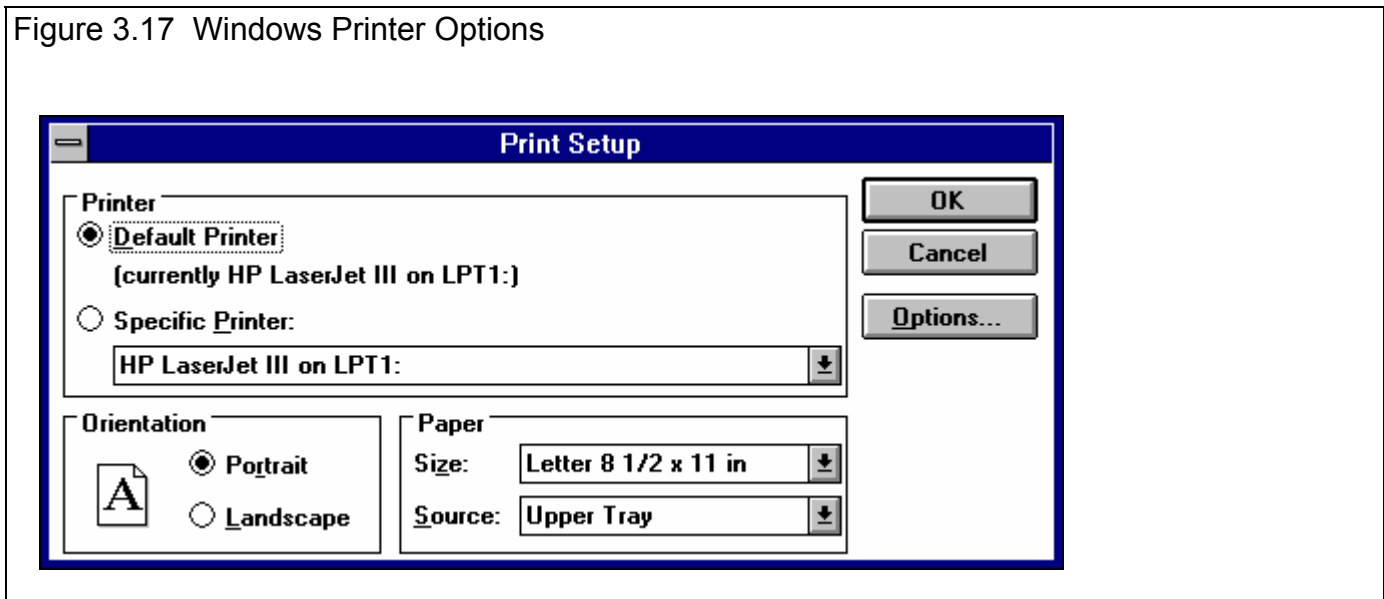

Figure 3.17 Windows Printer Options



Cursor

The cursor feature is very useful for determining or comparing the value of the graph lines at various places. See Figure 3.18 for explaining the use of the cursor.

Figure 3.18 Cursor Features and Commands

Cursor line, usually pink or green, depending on background color.

Click on these buttons to move the cursor left or right. Hold down the <shift key> while clicking these buttons and the cursor moves farther. You can enable the cursor by clicking on View, then Turn Cursor On.

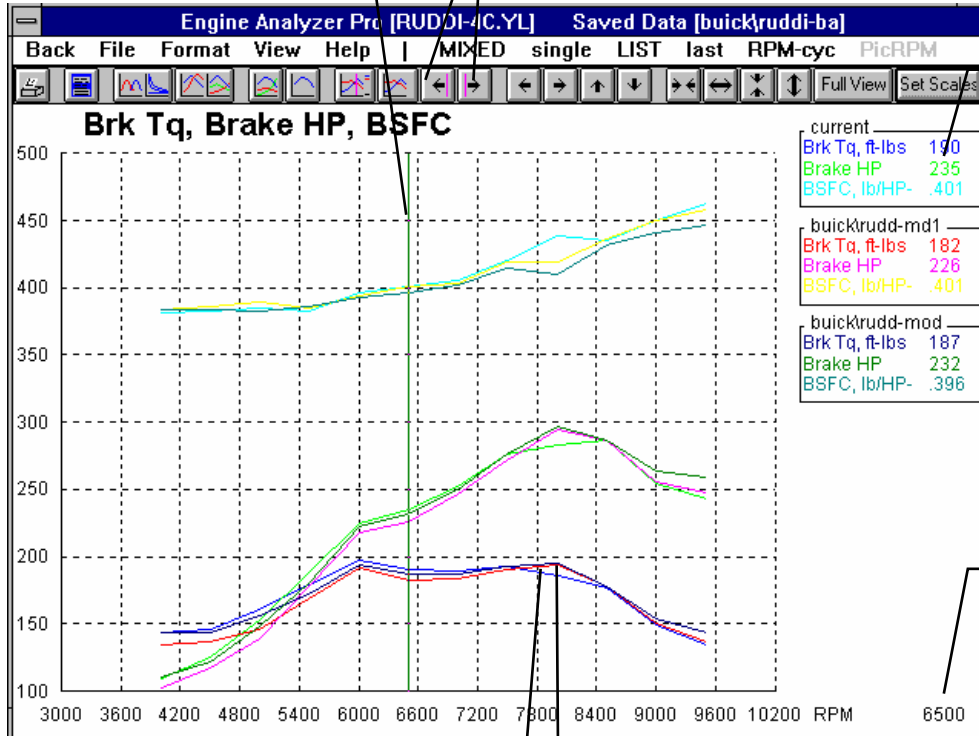

The value of each graph line at the cursor is displayed here.

Important: Note that in this graph BSFC was graphed after being multiplied by 1000. This is so it would show up on a graph of torque and HP. However, the value displayed here is the actual BSFC value of .396 to .401.

The X value of the cursor is shown here, in this case the RPM of 6500.

If you click on a graph line in between data points, the cursor will not appear. A data point is where you see a definite point or bend in a graph line.

You can also enable the cursor by single clicking on a graph line **at a data point**. This also provides a quick way to move the cursor from 1 area of the graph to another. (Do not drag the mouse while clicking or you will zoom in on that area.)

Changing titles and legend names

Many times you may want to customize a graph by printing labels of your choice. Click on Format and then Edit Titles/Legend to bring up the menu shown in Figure 3.19 which will allow you to do this.

Figure 3.19 Menu to Edit Title and Legend

This is the list of Standard names the program uses unless you click on the Use New Titles button below. Select (click on) a Standard name you want to change. The Standard Name appears in the edit box, along with the current New name if there is one. **Once you have selected a name from this list (that row will be highlighted) it is easier to use the up and down arrow keys to select the next item to edit than clicking the item with the mouse.**

This is the list of New names the program will use if you click on Use New Titles. If a title in the List of New Names is blank, the program will use the Standard name.

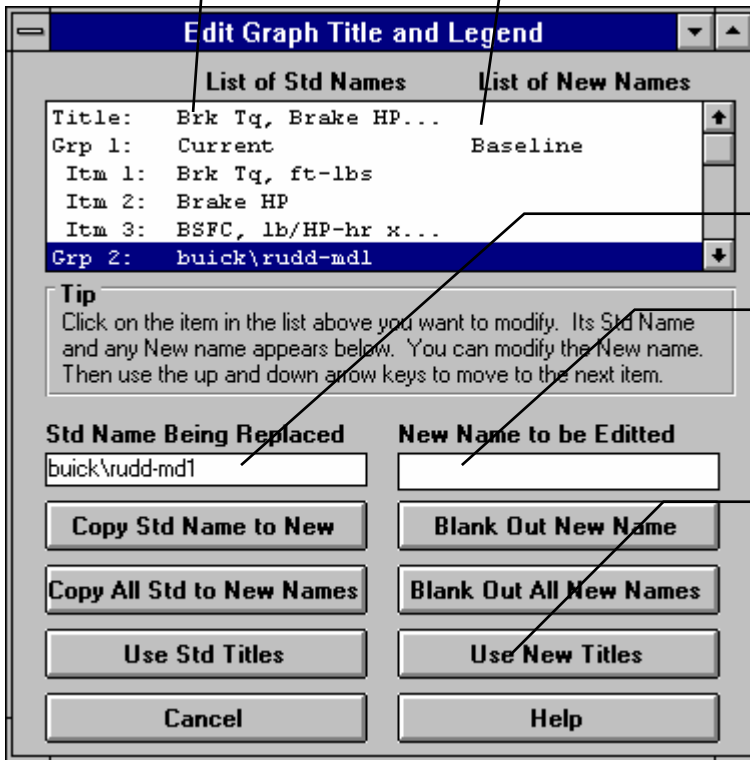

Standard name from row selected.

New name for you to edit. Other options include clicking on the Copy Std Name to New or Blank Out New Name buttons.

Click here to close this menu and use the New names you have entered. Where New names have been left blank, the Standard name will be used.

Changing the scales

Many times you may want to change the scale of the X or Y axis. This may be to show an area in more detail or to match the scales of a previous graph. The Pro has several ways to change the scales as shown in Figures 3.20 and 3.21.

Figure 3.20 Changing Scales for the X or Y Axis

Clicking on these buttons shifts the graph left, right, up or down. Hold down the shift key while clicking on them and the graph moves farther each step.

Clicking on these buttons zooms in or zooms out on the graph, either vertically or horizontally. Hold down the shift key while clicking on them and the graph moves farther each step.

Click here to restore "auto-scaling". That is where the computer picks the scale to show all the graph in good detail.

You can use the mouse to outline an area to be zoomed in on. Simply click on the mouse key in the upper left corner of the area, then hold the key down and drag the mouse to the lower right corner of the desired area. A box will be drawn as shown. When you release the mouse key, this area will fill the whole graph. This feature is disabled if the cursor is turned on. Also, start the upper left corner well away from a graph line or the program may turn on the cursor instead.

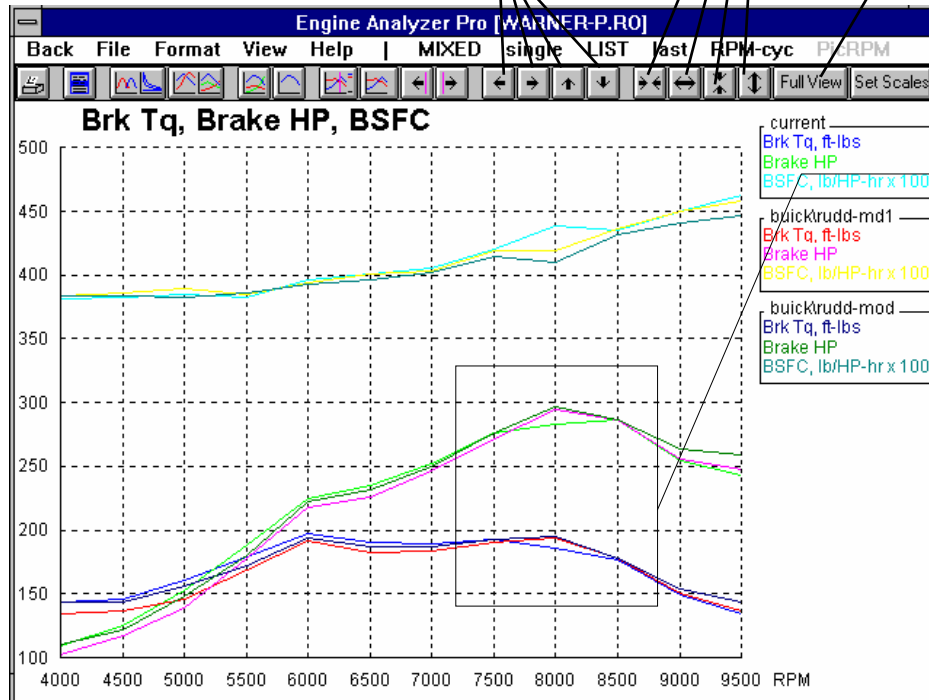
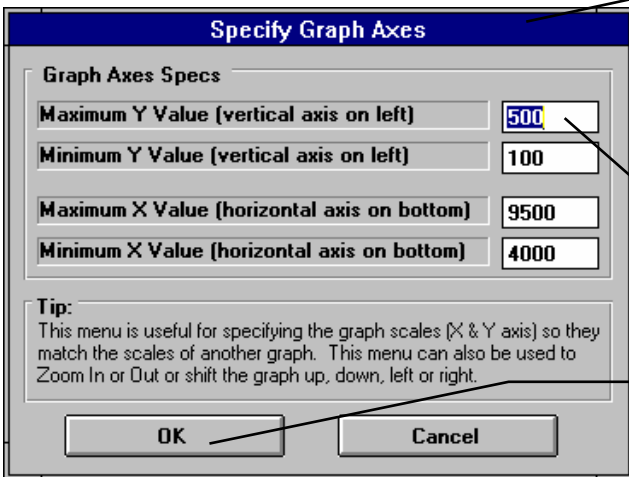

Figure 3.21 Menu to Specify Graph Axes Scales



This menu can be obtained 2 ways. You can click on View in the menu bar then Specify Scales (axes), or click on the Set Scales button, the right most button on the screen.

The current scale limits are loaded when this menu opens. Change any or all these to most any value you want.

Click on OK to have the graph redrawn to these new scale limits.

Cycle Plot Parameters:

This section gives a brief description of all the possible cycle plots. As shown, some cycle plots are independent of RPM. Therefore, it does not matter what RPM you pick when plotting this cycle data.

Cyl Pres	Cylinder pressure in PSI absolute or PSIA.
Cyl Temp	Cylinder temperature in °F.
In Port Vel	The actual velocity of the charge in the intake port in feet per second. (This is not the velocity based on incompressible flow equations: piston speed x piston area / int runner area).
Ex Port Vel	The actual velocity of the charge in the exhaust port in feet per second. (This is not the velocity based on incompressible flow equations: piston speed x piston area / exh runner area).
In Vlv Lift	The theoretical position of the valve as directed by the cam profile in inches (cam lift x rocker arm ratio - valve lash).
In Cam Vel	The velocity of the theoretical tappet position with respect to crank degrees discounting any valve train dynamics (bending or tossing). The units are inches per cam degree x 1000.
In Cam Accl	The acceleration of the theoretical tappet position with respect to crank degrees discounting any valve train dynamics (bending or tossing). The units are inches per cam degree per crank degree x 1000.
Act IVLift	The actual position of the valve as directed by the cam profile but also accounting for valve train dynamics (bending and "tossing").
In Flow Ar	The effective intake valve opening in square inches based on Act IVLift. Effective valve opening is calculated by:

$$\text{In FlowAr} = \text{Geometric Area} \times \text{Flow Coef}$$

Where Geometric Area and Flow Coef are changing at each lift point. For example, if the valve opening area is 1.5 square inches at .35" of valve lift, and the flow coefficient at .35" is .5, the In Flow Ar is .75 square inches at .35" valve lift.

In Pshrd F	The theoretical pushrod force in pounds. This value should correlate to data from strain gauged push rods.
Ex Vlv Lift	See In Vlv Lift above.
Ex Cam Vel	See In Cam Vel above.
Ex Cam Accl	See In Cam Accl above.
Act EVLift	See Act IVLift above.
Ex Flow Ar	See In Flow Ar above.
Ex Pshrd F	See In Pshrd F above.
InPort Pres	Pressure in the intake port next to the valve in PSI absolute.
Ex Port Pres	Pressure in the exhaust port next to the valve in PSI absolute.
Pstn Vel	Piston velocity in feet per minute.

Pstn Gs	Piston acceleration in Gs.
Pstn Thrst	Piston thrust force on the side of the cylinder wall from cylinder pressure in pounds, neglecting piston and connecting rod mass and inertia effects.
Carb Signal	The instantaneous fuel metering signal produces by the carburetor venturi in " water. Note: Due to a special case in the calculations, if you are running a draw through supercharger or turbocharger, this value will be plotted as 0. Its actual value for this case is not 0.
Pstn Pos	The piston position from TDC in inches. At TDC (360 and 720 degrees), this will be 0; at BDC (180 and 540 degrees), this will be the piston stroke.
Instnns Tq	The instantaneous torque produced from 1 cylinder of the engine in ft lbs.
Heat Trnsfr	The instantaneous rate of heat loss from the combustion gases to the cylinder head, cylinder walls and piston top in BTU/sec. Multiply this value by .71 to obtain the instantaneous HP loss.
Cyl Vol	The instantaneous cylinder volume in cubic inches. When the piston is at TDC (360 and 720 degrees), this is the clearance volume. When the piston is at BDC (180 and 540 degrees), this is the clearance volume plus the swept volume.

Enterprise Edition adds new Valve Spring details. See Appendix 13.

3.5 Printer Output

The Graphing Features have been greatly expanded in later versions. See Appendices 9 - 13 on pages 235-312 for more updated info.

The Engine Analyzer Pro can print the tabular test results for a permanent hardcopy by clicking on Print in the menu bar or the Printer icon. The menu of options shown in Figure 3.22 will appear. Check the options you want to use for the printout by clicking on any or all of the top for boxes. All options and buttons are discussed in this section.

Figure 3.22 Printer Command and Menu of Printer Output Options

This options lets you choose the printer or printer driver being used by Windows and also page orientation.

Click on Print or the Printer button for the Printout Options menu shown to the right.

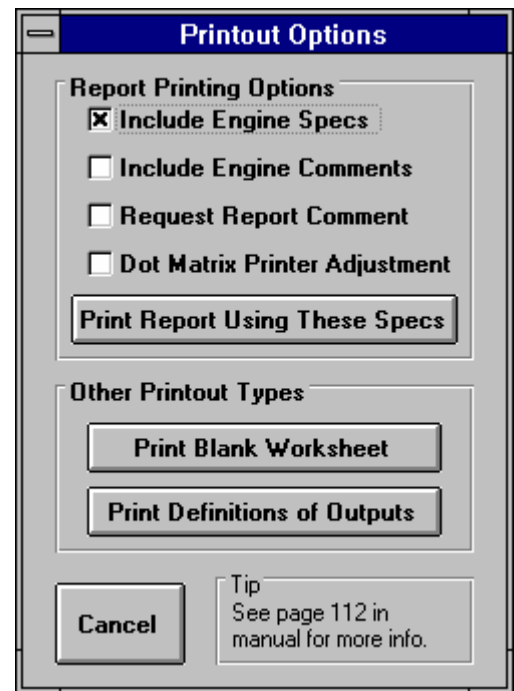
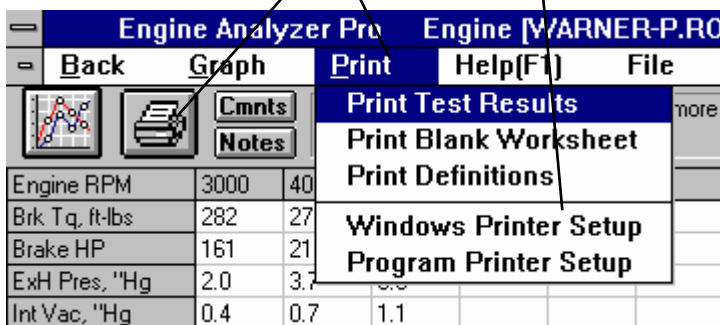

Include Engine Specs

Select this options if you want all the current Short Block specs, cylinder Head(s) specs, etc printed with the results. This will add 2-4 pages to the printed report.

Include Engine Comments

Select this option if you want all the comments for the complete engine file and the Short Block specs, cylinder Head(s) specs, etc printed with the results.

Request Report Comment

Select this option if you want to be asked for a comment for each particular report you send to the printer. These "report comments" are useful to identify important points for future reference, like modifications, engine results, etc.

Dot Matrix Printer Adjustment

If you are using a dot matrix printer, the standard printout may have printed text extending outside the borders. Select this option and the borders and indent spacing are adjusted for these situations.

Other Printout Types

Print Blank Worksheet

Click on this button to produce a list of major engine specs with blank lines next to them. These "worksheets" are handy for gathering engine specs when creating new engines with the Pro.

Print Help Definitions

Click on this button to produce a list of output parameters with a 1 line definition. These definitions are the same as when you click on sections of the test results and help is displayed.

3.6 Data Libraries

The Data Library Features have been greatly expanded in later versions, especially for using simplified Standard Engine Analyzer Example component files. See Appendices 9 - 13 on pages 235-312 for more updated info.

The Engine Analyzer Pro allows you to save sets of engine specifications to the Engine Library, and sets of component specs (Short Blocks, cylinder Head(s), etc) in separate Component Libraries. In addition, you can save calculated test results for analysis or comparison in the future. Test Files also contain the engine (and component) specs which produced the test results.

The organization of Data Libraries is illustrated in Figure 3.23.

Figure 3.23 Organization of Data Libraries (Help screen from Main Menu)

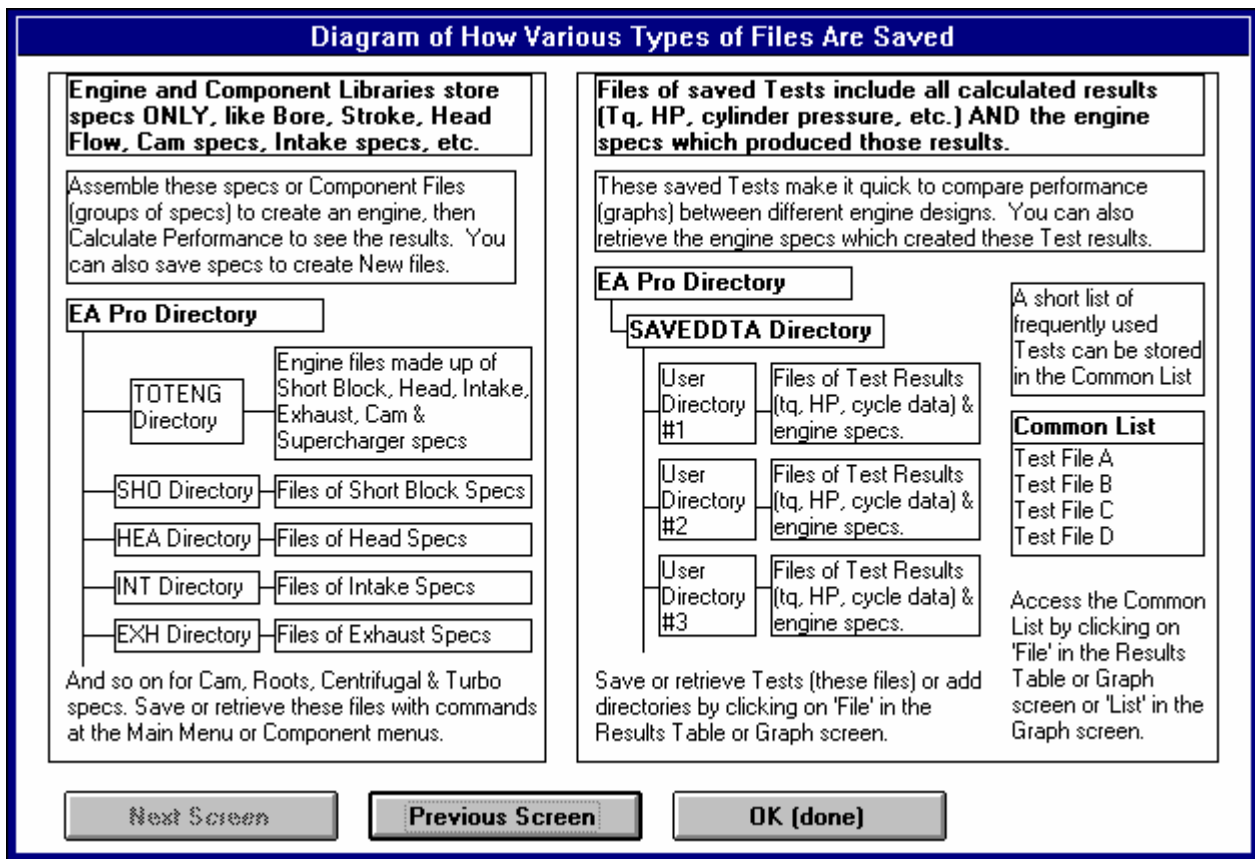

As shown in Figure 3.23, complete Engine Files are stored in the TOTENG directory, and Component Files are stored in separate component directories. All Test Files are stored in separate directories under the SAVEDDTA directory. The number of Test Files can grow quite large. When you want to compare the current test results with a particular saved Test File, it is time consuming to have to sort through the various directories and test files to find it. That is why there is the Common List, or List of Commonly Used Test Files. Here you can store a small number of Test Files for easy recall.

Example of Using and Saving Specs and Test Data

For example, say you are working on a small block 302 Ford. You want to switch to TFS heads, EFI intake and new cam with good street performance.

- Enter all the specs for the carbureted 302 Ford. Get in the habit to also change all the comments in the component menus and the main menu to match the actual specs you've entered. This will save a lot of confusion in the future if you save these specs and retrieve them in the future. See Figure 3.24.
- If any of the components are something you think you may use again in the future, say cylinder head with the flow curves, you will want to save these component specs. In the Cylinder Head(s) menu click on the Save to Library button. When asked if you want to Save Specs to Same File Name, answer No. Then give the program a new name for these Head Specs, say PROD-302. See Figure 3.24. Note that the program always presents this menu with the current file name loaded, in this case PROD-GT40. This allows you to make minor modifications to it to create the new file name.
- Definitely save all the engine specs at the Main Menu by clicking on the Save button. This will save an Engine File of all specs. When asked if you want to Save Specs to Same File Name, answer No. Then give the program a new name for this complete Engine File, say BASE-302. See Figure 3.24 and 3.25.
- Calculate performance to obtain the Baseline test results. Save these results by clicking on File, then Save Current Results to Disk. If this is going to be a big project, you may want to create a separate directory for saving the Test File. If so, click on the Add Directory button and enter an appropriate name, say JOES-302. Then select this directory and enter a New Test Name as shown in Figure 3.26. Enter a name like BASECARB.
- Since the Baseline Performance is a test file you will refer to often for graph comparisons, save this new Test File name to the Common List. Back at the Test Results screen, click on File and then Add Saved Test to Common List.. Here you can access all directories under SAVEDDTA and all files in each directory. Find and highlight the directory you just created, JOES-302. Then find the BASECARB file, click on it to highlight it and then click on the Add to List and Select for Graphing button. It will appear both in the common list and be highlighted (selected). You may want to delete some of the existing files from the Common List (they are still saved as a Test File), or at least de-select files which do not relate to the 302 Ford you are working on.
- Now return to the Main Menu by pressing the <Esc> key or clicking on Back. Make changes to the specs to match the new heads, new intake, etc. Calculate performance and compare the test results to the Baseline you've saved in the Common List. You should also save Test Files of results for combinations *which look promising*, and add these files to the Common List. This will provide a quick list of various results for easy graph comparisons. (These results may not warrant saving the components or engine specs as Component or Engine files, but these specs are saved with the Test File anyway should they become important in the future.)
- For components which are set (like stock TFS heads) and you want to keep the specs for future reference or for use on other engines, save them as shown earlier. At important intermediate steps, you may also want to save the engine specs as an Engine File. You will definitely want to save your final design as a complete engine file. Again, be sure to update all engine and component comments to be accurate with the current specs.

3.24 Saving Component Files

Select No and the program will ask you for a New Component Name in the menu shown to the right.

Current Component File Name

Be sure to update comments in addition to the specs. These comments are very useful should you retrieve this component file in the future.

The program presents the current file name for editing. Change it to most any name for the component file. The program warns you if the file name already exists or there is a problem with the name.

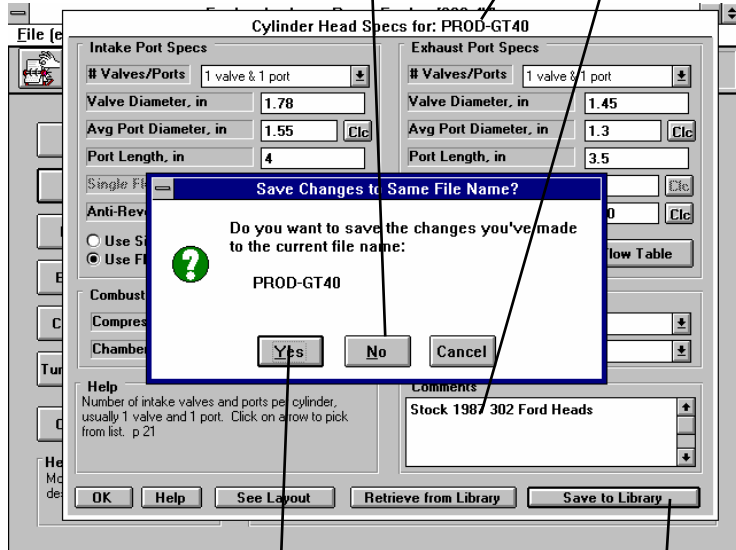

Click on Yes and the program will update the current file name with current specs.

Click here to start the process of saving the current component specs as a component file.

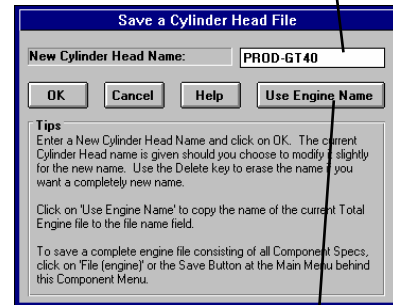

Click here and the current Engine Name will be entered as the Component name.

Figure 3.25 Saving a Complete Engine File

Click on Save button is same as clicking on File and then Save As. The process then matches saving a Component File as shown in Figure 3.24, except it will show you all the Component File names and comments, should you want to change something before saving the Engine File.

Click on File, then Save (saves specs to current Engine name) or Save As (asks for new Engine Name.)

Current Engine File Name

Update the Engine Comments to match the current engine design.

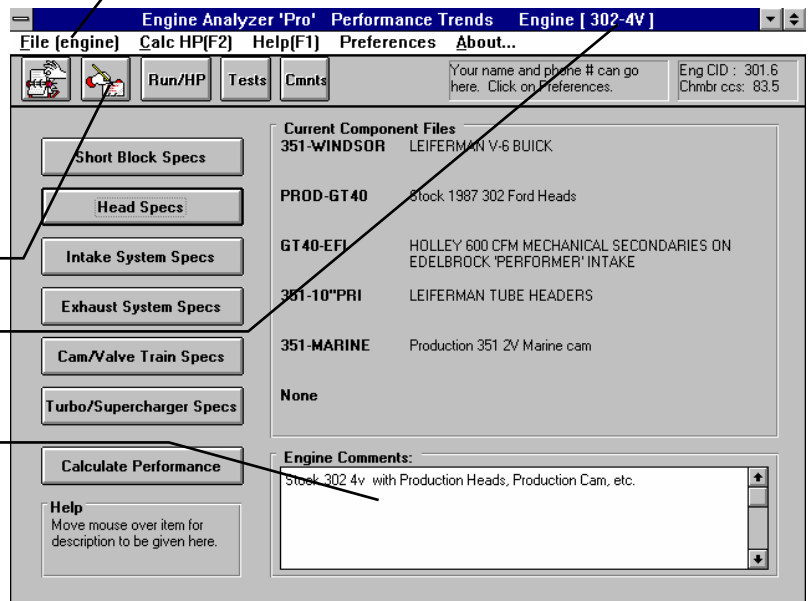
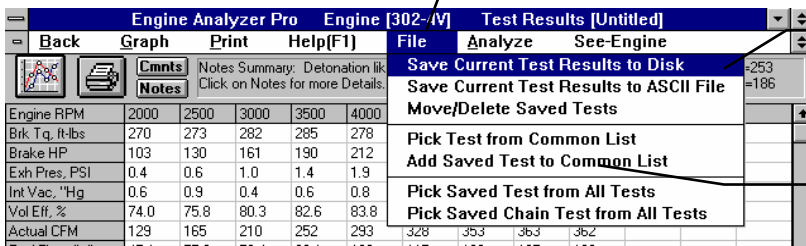

Figure 3.26 Saving Test Files

Click on File for options on saving Test Files and adding them to the Common List.



The first option lets you save the current Test Results (and the engine specs which produced those results) to a Test File on disk.

This option lets you add a Test File which has been saved to the Common List. See Figure 3.27.

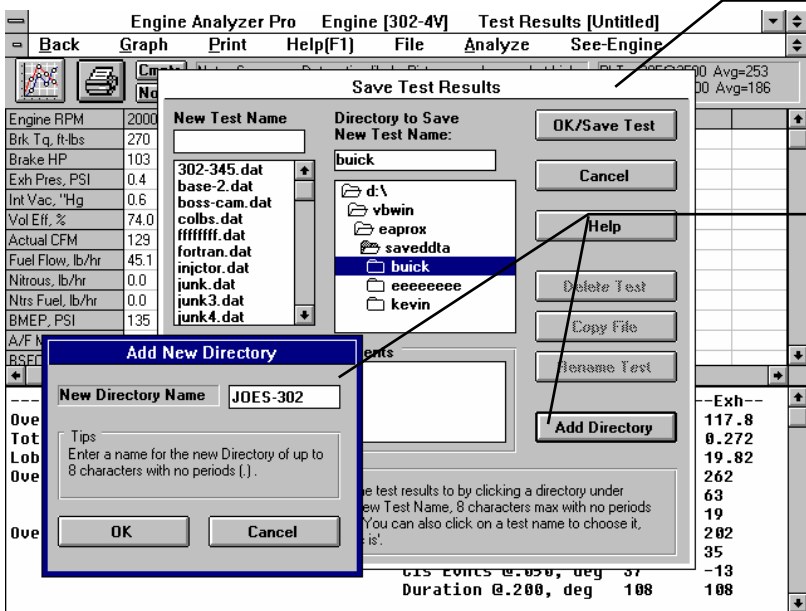

After Clicking File and Saving Current Test Results to Disk, this menu appears. Several options (buttons) are disabled, unless you would have chosen File and then Move/Delete Saved Tests.

This menu appears after you click on the Add Directory button. Enter most any name of 8 letters, no periods. This name will be added to the list of directories under SAVEDDTA. See the figure below.

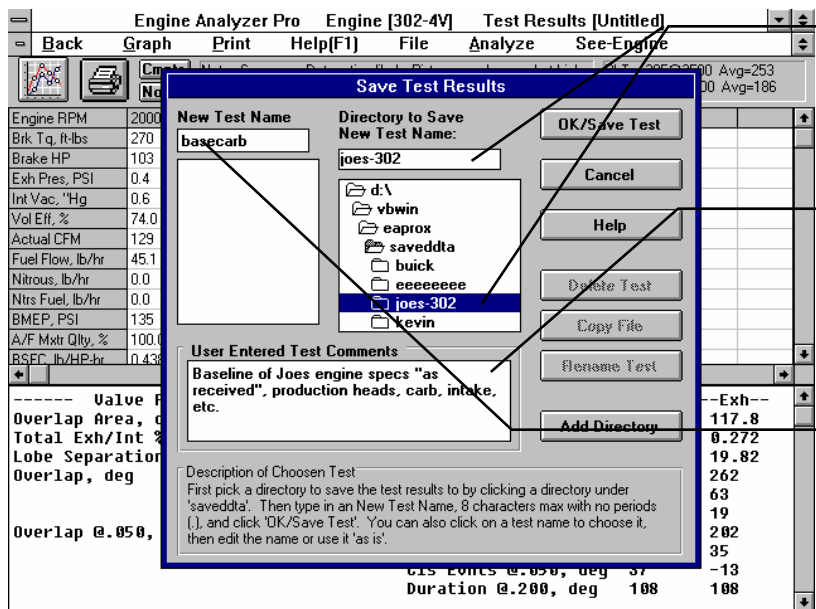

After adding the new directory, click on it to tell the program that is where you want to store these new test results.

Enter any comments to better describe this test. These comments will be shown in a preview when you retrieve this test in the future.

Enter a name for the test results file. You can also click on a file name in the list below (shown empty here). That name will appear in this box. You can use this name or modify it slightly for the name of the Test Results file. Then Click on the OK/Save Test button.

Figure 3.27 Adding Saved Test Files to the Common List

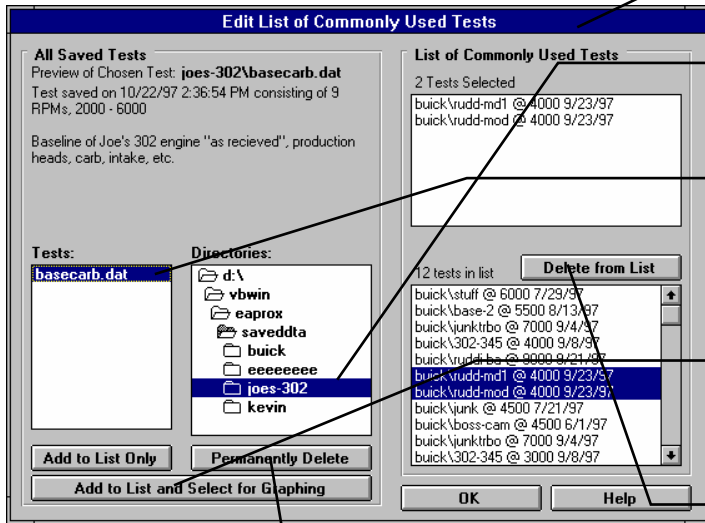

This screen appears when you click on File and then Add Saved Test to Common List.

First select directory where file is Saved. All Test Files in this directory will appear in list of Tests to the left.

Click on the Test File you want to add to the Common List. A preview of this Test appears above it. Notice that here is where the test comments appear to remind you of what this test was.

Click on one of the Add buttons. Since this is a test we will surely want to graph with other tests of these 302 specs, click on the Add to List and Select for Graphing button.

Click on this button and a new menu showing the Common List appears. Here you can select which files to remove from the list. However, they remain saved to disk.

Click here and the selected Test will be deleted from disk.

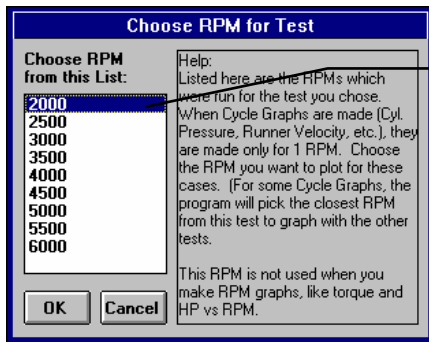

After you select a test to add to the Common List, the program will ask which RPM's Cycle Data should be graphed if Cycle Data is Graphed. Pick 1 RPM from this list, then click OK.

For RPM graphs, like torque and HP vs RPM, data for all RPMs are graphed.

If there are more than 1 RPM you want to graph Cycle Data for, then you must add this Test File again to the Common List and select a different RPM from this list.

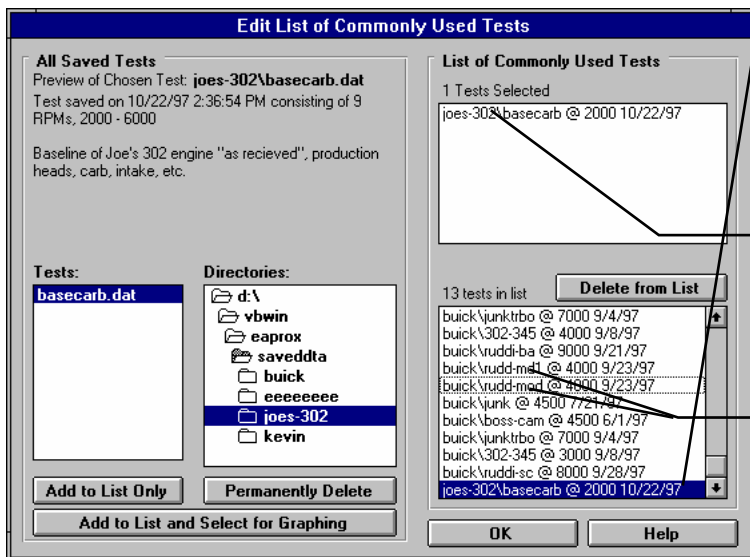

After picking an RPM for Cycle Data, the Test File appears in the Common List and is highlighted. Note that the directory, Cycle Data RPM and date are also listed with the file name.

The test also appears here, as a selected test. These selected test from the common list are the ones graphed when you click on List in the Graph Screen.

To de-select the 2 "buick/rudd" Test Files, click on them in this list. They will become "unhighlighted" and be removed from the list of Selected Tests. They remain in the Common List for quick recall should you need them.

Figure 3.28 Retrieving an Engine File (retrieving a Component File is similar)

Click on File, then Retrieve or the Retrieve button from the Main Menu to retrieve an Engine File from the Engine Library. Click on the Retrieve from Library button in the Component Specs menus to retrieve Component Files from the Component Libraries.

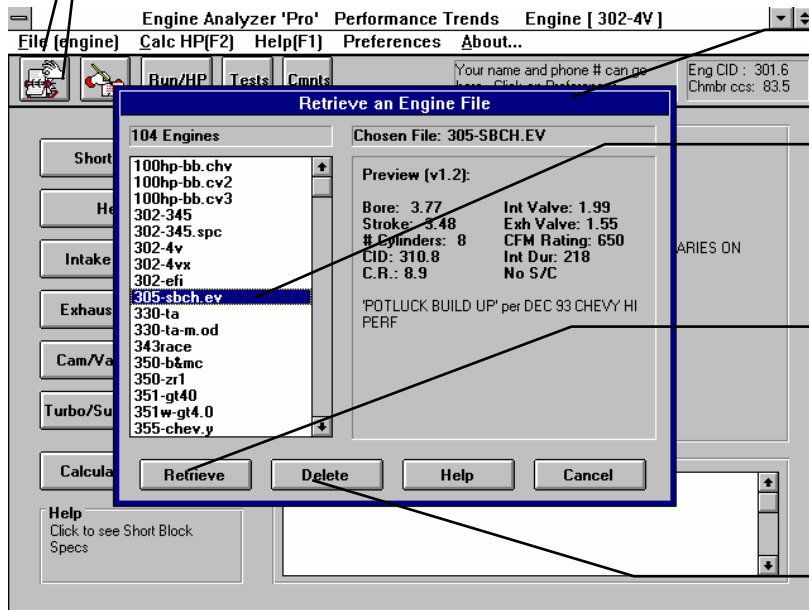

This is the typical menu to retrieve either an Engine or Component File.

Click on a file name and its name appears as the Chosen File and a preview of its specs and comments is given to the right.

Click here and the current specs will be replaced with the Chosen File's specs. The program will first ask if you want to save the current specs before they are replaced.

Click here to permanently delete the file from disk.

Figure 3.29 Retrieving a Test File for Tabular Display (not just graphing)

Click on File and then on one of the Pick file options, depending on if you want to retrieve a standard test or a Chain test.

Click on a directory and then a Test file from the list for that directory. A summary or preview is given above.

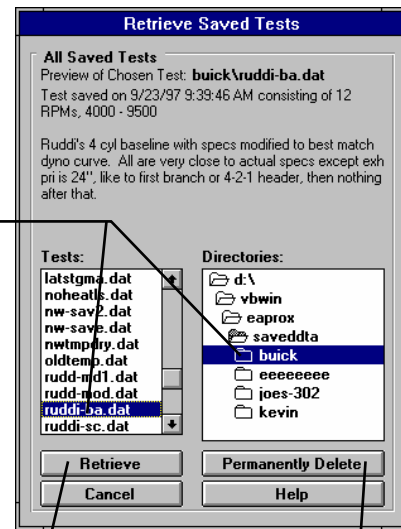
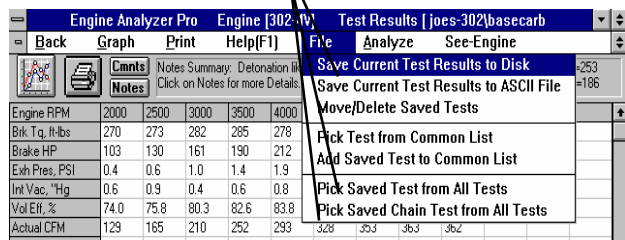

Click here to retrieve this test file. You will be then asked if you want to retrieve the Engine specs which produced these results. The Test Results will be shown in tabular form and this data will now be called the Current results. If you do retrieve the engine specs also, you can do special analysis like an Analysis Report or use the See Engine feature to watch actual engine operation.

Click here to delete the chosen Test File from disk.

3.7 See Engine

A new feature for version 2.1 is the ability to watch the valves and piston interact throughout the cycle, while also watching the tuning pressures and flows. This screen is useful for pointing out trends in piston to valve interference, valve toss and valve train bending, etc. Figure 3.30 explains the major features of this screen.

In order to enter this screen, you must have just calculated Test results or retrieved a saved test and retrieved the Engine File which produced those test results.

Figure 3.30 See Engine Screen

The screenshot shows the 'Watch Chamber and Valves' window. At the top is a valve lift graph. Below it is a detailed view of the combustion chamber with a piston and valves. To the right is a data table for valve and clearance specifications. At the bottom are navigation buttons.

Valve Angle	Exhaust	23	Intake	23
Inches from Valve to Head Surface		.08		.01
Valve Diameter		1.62		2.08
Piston to Valve		.186		-.197
Min Piston to Valve		-.116		-.255
Valve Toss		.000		.000
Valve Train Bndng		.034		.001
Actual Valve Lift		.068		.441
Theo. Valve Lift		.102		.442

This valve lift graph gives you a general idea of where you are in the 4 stroke cycle. This graph can be changed to runner velocities or runner pressures by clicking on the Options button.

This "cursor" shows exactly where you are. Click on a different area of the graph and the cursor will move to that point and the screen is updated to that points data.

Arrows show runner velocity and direction. Reverse direction drawn in red. The longer the arrow, the higher the velocity. Exhaust velocity drawn to smaller scale.

Digital (exact) runner velocity and pressure given here.

Relative runner pressure shown graphically here.

Exact crank angle shown here. Enter angle & screen is updated to that point.

Enter these specs for accurate piston-to-valve clearance. These are saved with Engine file (not Head or Short Block file). Examples of some specs available by clicking on Options.

Minimum piston-to-valve is displayed in red if clearance is less than .100". Click on Help for more info.

Valve Train Dynamics specs shown here. Click on Help for more info.

Piston-to-valve clearance shown here. It is very important to enter correct dimensions in this screen. Click on Help for more info.

Although valves are drawn in a typical "wedge" layout, the clearance calculated for hemi and 4 valve engines is accurate if the correct valve angle is entered. This angle is be the **largest** angle between the bore axis and the valve axis. For a safety factor, be sure not to overestimate this angle.

These buttons let you advance or back up 1 step (4 degrees) or run continuously. Continuous is useful to actually see trends with flows and valve/piston motion.

Figure 3.31 See-Engine Options Menu

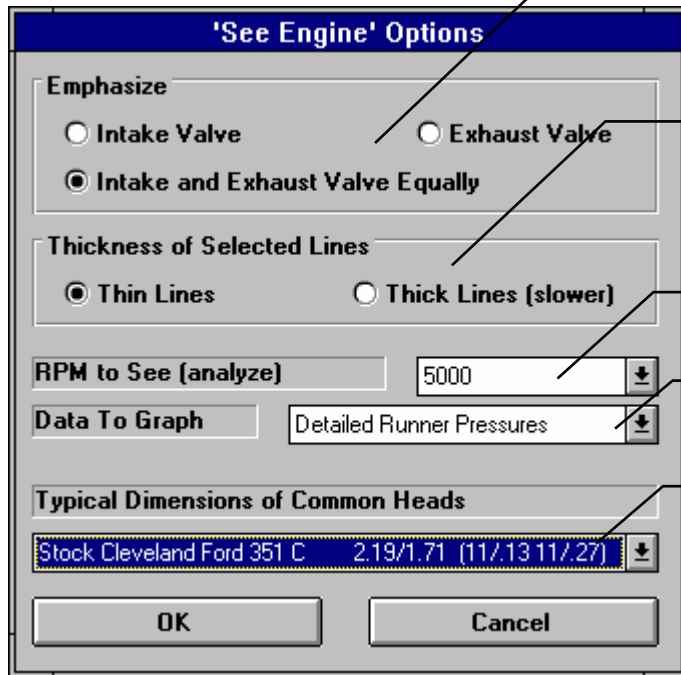

Determines which valve is drawn with more emphasis. See explanation below.

Determines if emphasis is shown with thick vs thin lines, or thin vs thin dotted lines.

Lets you pick the RPM to analyze of the RPMs run for this particular test.

Lets you change the graph which appears above the piston and valve graphic.

Lets you pick an example of typical valve angles and Inches from Valve to Head Surface numbers. **For best accuracy, you should use measurements from your own heads.**

Figure 3.32 Illustration of Inches from Valve to Head Surface

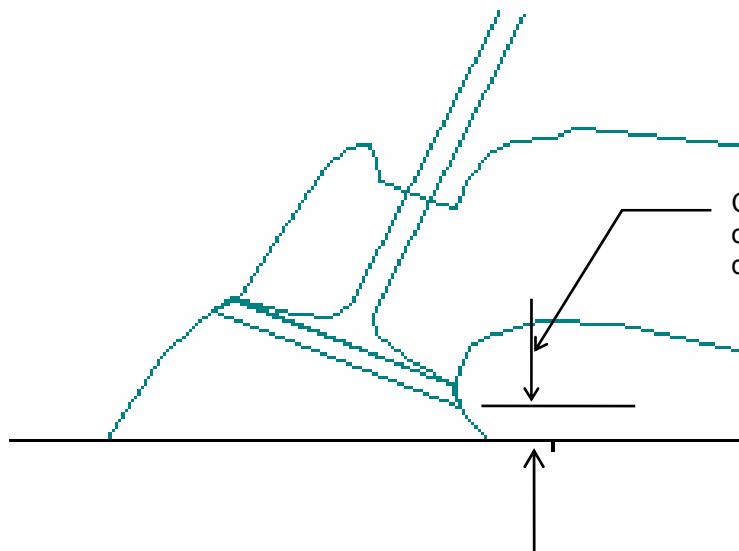

Closest distance from edge of valve to cylinder head deck surface in inches.

The See Engine Features have been greatly expanded in later versions. See Appendices 9 - 13 on pages 235-312 for more updated info.

Chapter 4 Examples

The examples in this section start off with the various engine files exactly as you received them with the Engine Analyzer Pro diskette. For example, Example 4.1 uses the RSTR-SBCHEV engine file. To obtain a copy of RSTR- SBCHEV:

Click on either File (engine) then Load Engine from the Menu bar at the Main Menu.
Click on the Retrieve button at the Main Menu. See Example 4.1.

Each example becomes progressively more complex, assuming you have performed and understand the preceding example. Section 1.5's example is somewhat more basic than Example 4.1, so it may be a better place to start if Example 4.1 looks complicated.

Most examples consist of 2 sections, the first section for all users and a second section "For Advanced Users". These second sections show a more detailed analysis to illustrate the use of the Pro's many features.

The results shown in these examples may be somewhat different than what you obtain with your particular version of the program That is due to minor upgrades in the calculations in later versions.

Please visit the Performance Trends website (www.performancetrends.com) for additional information, including Demo Movie files which show how to use the program's many features. These are available by clicking on Support from the drop down menu at the top of most any page, then selecting Movie Demo Files. See below.

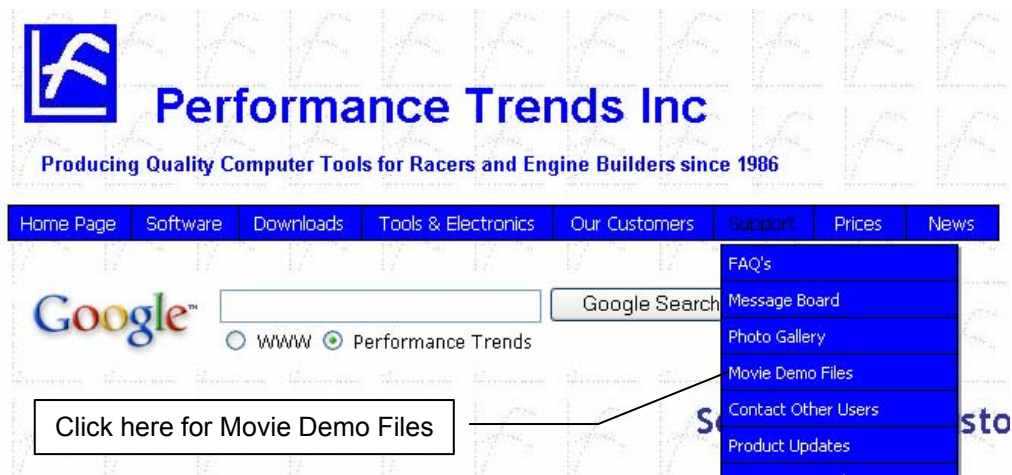

Example 4.1 Installing Larger Carburetor And Intake Manifold

Features Introduced (and suggested background reading):

- Section 1.5, Example To Get You Going
- Changing Intake System specs (Section 2.4)
- Calculate Performance and evaluating Test results (Section 2.8)
- Using Calculation Menus (Section 2.9)
- Graphing results (Section 3.4)

Example 4.1 will be fairly simple to get you started. We will attempt to answer the question:

What performance improvement can be expected from a 355 Chevy with 255 CFM 2 BBL (Holley 350) with Performer dual plane engine, by switching to a 400 CFM 2 BBL (Holley 500) with a Victor Jr single plane intake?

This will be done by modifying the Intake System specs to simulate installing the larger carb with a single plane manifold. We will then see the effect on Test Results, especially torque and HP.

First, start the Engine Analyzer Pro program following the procedure in Section 1.4 by either:

- Clicking on the Engine Analyzer Pro icon in the Perf. Trends program group.
- Clicking on the EAP.EXE (EAP) program under the EAP directory (folder) under the PERFTRNS.PTI directory (folder) using File Manager (Windows Explorer). (Terms in parentheses are for Windows 95.)

You will be given the Engine Analyzer Pro's Main Menu. Notice at the top of the screen that the current Engine file is a SUPERSTOCK Buick V-6.

To obtain the engine file RSTR-SBCHEV, click on the Retrieve button as shown in Figure 4.1. Retrieve the Engine file RSTR-SBCHEV as shown in Figure 4.2. If you have made any changes to the SUPERSTOCK engine file, the program will first ask you if you want to save these changes. Answer No and you will be returned to the Main Menu with the RSTR-SBCHEV specs loaded into the program. The original SUPERSTOCK engine file will remain safely in the library for future use. (If you had wanted to save any recent changes to the original SUPERSTOCK specs, you could have answered Yes. The program would then ask if you want to save then to the same name, overwriting SUPERSTOCK with these changes or to save the changes under a new name.)

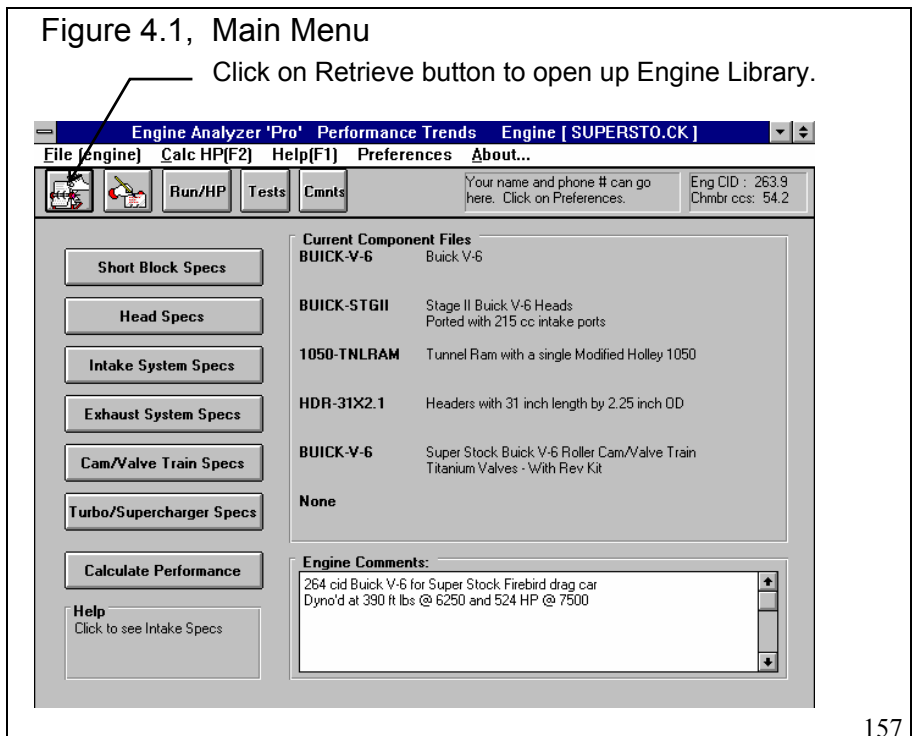

Click on the different categories of engine specs or the Calculate Performance button on the Main Menu. Since we want to see the effect of installing a carb and manifold on this engine, we first need to get a "baseline" test. A "baseline" is a performance test before the modification. Therefore, if you examine the contents of any component menus, leave all current values as they are.

Click on the Calculate Performance button and you will now be shown the Calculation Conditions screen. This screen gives the conditions for calculating performance: weather, fuel, RPMs to run, etc. For now, leave these values as they are.

Proceed with the calculations clicking on the Calculate Performance button.

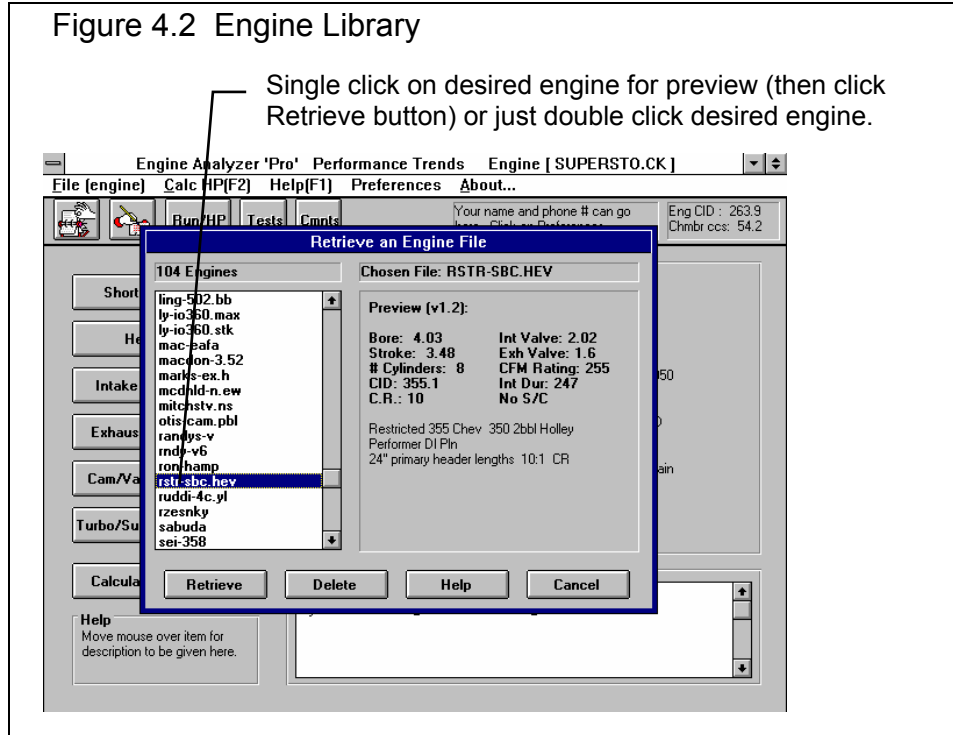

Before calculations are started, basic checks are made of the input specs for unusual combinations. The program points out that this carb looks quite small for this engine size and displays the warning:

Total CFM Rating looks restrictive for this engine size Continue with Calculations anyway?

Since this is the carb we must run and the Total CFM Rating is accurate, click on Yes and the program will continue with the performance calculation.

The program will display the Calculation Progress indicator as shown in Figure 4.3, with the last approximate volumetric efficiency the program has calculated for each RPM. This information shows you how far the calculations have progressed, and how stable the calculations are. If the volumetric efficiencies are "jumping" high, then low, then high again, a problem may be indicated. For example, the RPM being calculated may be too low for stable running with a "loppy", high RPM cam.

When the calculations are finished, the performance results will look like Figure 4.3. In the upper left corner, note the Pk Tq (peak torque) of 363 ft lbs at 3000 RPM and Pk HP (peak hp) of 307 HP at 6000 RPM. Write this down for comparison with results after installing the carburetor and manifold. We will want to see how this changes with the new intake system.

To obtain a torque and HP plot, click on the Graph button or Graph menu item. The program will present a graph similar to that shown in Figure 4.5. There are 2 basic type of plots the Engine Analyzer Pro makes:

- Performance data versus RPM
- Cycle data versus crank degrees, seconds or cylinder volume

If you do not see a graph or torque and HP vs RPM like Figure 4.5, then check to ensure the selections match what is shown in the Figure 4.5. and 4.6. See Section 3.4 for more details.

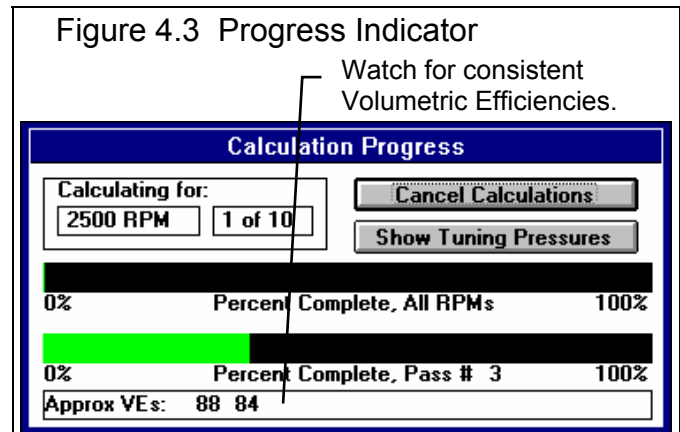

Figure 4.4 Baseline Results

Click here to Graph Performance Summary

Engine RPM	2500	3000	3500	4000	4500	5000	5500	6000	6500	7000
Brk Tq, ft-lbs	338	363	354	326	309	300	288	269	237	201
Brake HP	161	207	236	248	265	286	301	307	293	268
Exh Pres, PSI	0.1	0.2	0.3	0.3	0.4	0.4	0.5	0.6	0.7	0.7
Int Vac, "Hg	1.1	1.9	2.5	2.9	3.5	4.4	5.2	5.9	6.4	6.6
Vol Eff, %	75.1	81.4	80.8	76.4	74.4	74.6	73.7	72.1	69.3	64.9
Actual CFM	193	251	291	314	344	383	417	444	463	467
Fuel Flow, lb/hr	70.5	91.7	106	115	126	140	152	162	169	171
Nitrous, lb/hr	0.0	0.0	0.0	0.0	0.0	0.0	0.0	0.0	0.0	0.0
Ntrs Fuel, lb/hr	0.0	0.0	0.0	0.0	0.0	0.0	0.0	0.0	0.0	0.0
BMEP, PSI	143	154	151	138	131	127	122	114	101	85.4
A/F Mxtr Qlty, %	100.0	100.0	100.0	100.0	100.0	100.0	100.0	100.0	100.0	100.0
BSEC, lb/HP-hr	0.439	0.443	0.450	0.462	0.475	0.490	0.506	0.529	0.577	0.636

Notes Summary: Click on T/B View, small. Dataation (tab), Value Loss, Piston speed (Exhaust) high. Click on Notes for more

PKTq=363@3000 Avg=299
PKHP=307@6000 Avg=257

----- Valve Flow & Cam Calculations ----- --int-- --Exh--

Overlap Area, deg*sq-in	14.6	Ulv Area, deg*sq-in	278.0	215.0
Total Exh/Int %	77.3	Total Avg Flow/Int Coef	0.305	0.364
Lobe Separation, deg	106.3	Lobe Area, inch*deg	27.40	29.45
Overlap, deg	76	Duration, deg	284	294
		Opening Events, deg	43	80
		Closing Events, deg	62	33
Overlap @.050, deg	39	Duration @.050, deg	247	256
		Opn Evnts @.050, deg	24	61
		Cls Evnts @.050, deg	43	15
		Duration @.200, deg	160	169

Click on vertical scroll bar buttons and slide them up or down to display all results.

If more than 12 RPMs were calculated, use the horizontal scroll bar to display data for all the different RPMs.

Figure 4.5 Graph of Baseline Torque and HP

current
Brk Tq, ft-lbs
Brake HP

Torque & HP vs RPM

Back File Format View Help | MIXED single list last RPM-cyc PicRPM

Full View Set Scales

Both list and last should be in lower case, meaning only the current data is being graphed. If either are capitalized, click on them to turn them off.

MIXED should be capitalized to indicate 2 types of data are being graphed, torque and HP. If it is not, click on it to produce the Mixed Data menu of options shown in Figure 4.6.

Figure 4.6 Mixed Data Graph Format Menu (displayed by clicking on MIXED in the Graph Screen)

Click on this button to enable options on the left side of this menu.

Click on this button to enable the specs on the right side of this menu.

If this list is enabled (not dimmed to gray), choose the Torque and HP vs RPM pre-programmed graph pattern. If you do not see these data types, you are not doing RPM data graphs. See Figure 4.5.

If these specs are enabled (not dimmed to gray), choose specs from these combo boxed to match those shown here. If you do not see these data types, you are not doing RPM data graphs. See Figure 4.5.

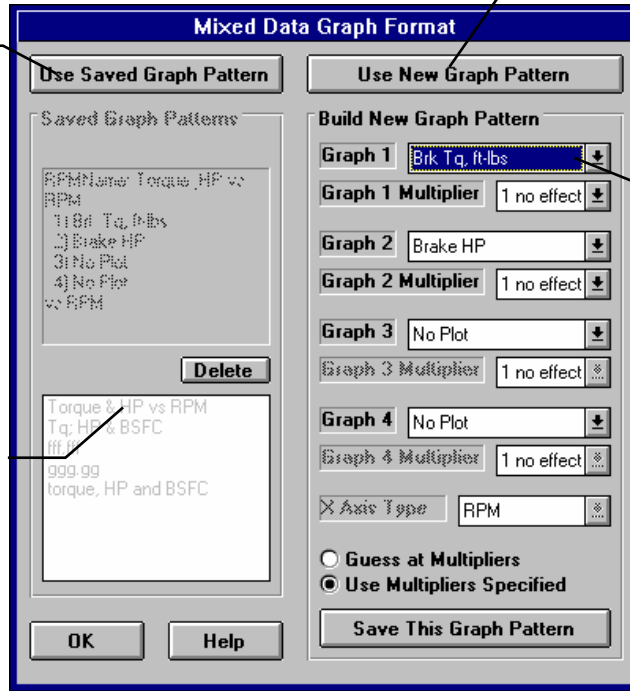

Now for the good part; lets install that carb and manifold. Get back to the Main Menu by clicking on Back in the menu bar (or pressing <ESC>) at the graph screen (Figure 4.5), then clicking on Back (or pressing <ESC>) again at the tabular Test Results screen (Figure 4.4).

When you return to the Main Menu, click on Intake System to obtain the Intake System menu as shown in Figure 4.7. The values in Figure 4.7 show specs for the new 400 2 BBL carburetor and manifold.

You will need to make 6 modifications to simulate installing this intake.

- Click on the Total CFM Rating and type 400 over the current value of 255 CFM. Note: This particular Holley 500 2 BBL flowed 400 CFM on a flow bench at 20.5" water (1.5 "Hg, mercury) . If it had not been flowed, we should have assumed it flowed 500 CFM at 3 "Hg, the standard 2 barrel rating pressure. We would need to convert this to CFM at 1.5" Hg which is what the program wants. The conversion is made by multiplying the 2 BBL CFM by .71, or in this case 500 x .71 = 355 CFM. See page 29. That would have been a more restrictive carb than the carb we actually installed. The same is true of the Holley 350 2 BBL which should have only flowed 249 CFM but actually flowed 255 CFM.
- Change the Manifold Type from Dual Plane-carb(s) to a Single Plane-carb(s) to identify the manifold being a lower rise single plane design, where all cylinders feed from a single plenum. The Single Plane type (as opposed to the Tunnel Ram-carb(s)) indicates a manifold with lesser tuning effects due to a design somewhat compromised for good overall driveability, smaller plenum and more bends in the runners.
- Calculate a new runner size for the larger ports in the new manifold by clicking on the Clc button for Runner Dia @ Head. See Section 2.9.3. At the Calc Avg Diameter calculation menu, chose No for Know Runner CCs?. Then enter the new manifold's runner dimensions, which measure 2.0" high by 1.2" wide. The runners are primarily rectangular, so choose

Rectangular for Runner Shape and you will obtain 1.75 for the new Calc Avg Diameter. Use this value by clicking on the Use Calc Value button.

- Enter a more appropriate runner flow coefficient for the "free flowing" single plane design. Since we do not have flow bench data, the Clc button and calculation menu will be no help. Therefore, refer to Table 2.7 in this manual and use a value of, say 2.5 which is in the middle of the range for "street" single plane manifolds. See page 26.
- The single plane has shorter runners than the original dual plane, some about 6", some about 2". Enter an average runner length of 4" for Runner Length, in. (Remember, this is the length of the runner in the intake manifold only, not the head and manifold.)
- Change Intake Heat to No Heat since the Victor Jr's runners are completely isolated from heat sources like coolant passages, exhaust crossover or the lifter valley.

You should also get in the habit of changing comments when you make major changes, as shown in Figure 4.7. Simply click on the comments box, delete out the old comments and type in the new description.

With these modifications made, click on the OK button in the Intake System menu. Then click on the Calculate Performance button and then Calculate Performance button in the Calculation Conditions menu, or just click on the Run/HP button at the top of the Main Menu

Now estimated performance shows a peak torque of 415 ft lbs at 4000 RPM and 386 HP at 6000 RPM. As with most "restricted" engines, this shows an impressive power increase with a larger carb. (See "For Advanced Users" at end of this example.)

To understand why the performance increased as it did, look at the estimated performance items Int Vac, In Tun Pres, and In Port Tmp. This is done most easily with a graph. Simply click on Single and select (double click) on these 3 data types one at a time. For Int Vac, you will obtain a graph like Figure 4.10.

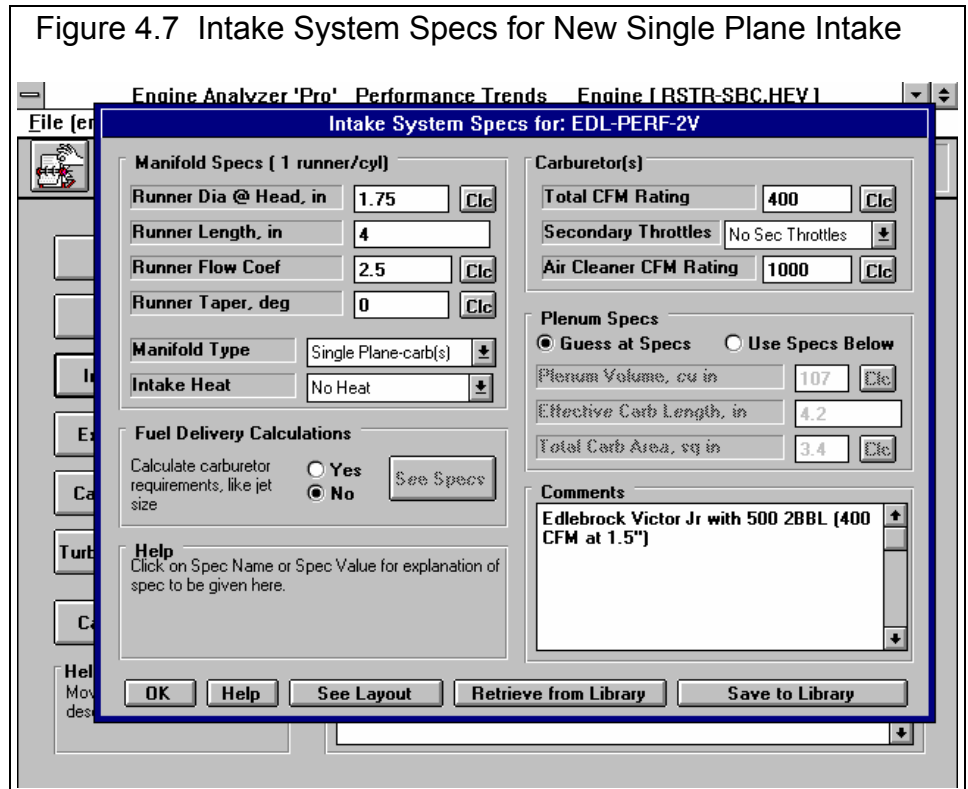

As one would expect, intake vacuum dropped with the larger carb and single plane intake. The 255 CFM carb produced 6.6" vacuum flowing 467 CFM where the 400 CFM carb produced only 3.4" vacuum while flowing a higher 578 CFM (at 7000).

In Tun Pres for the longer runner Dual Plane intake with the 350 carb was higher at most RPMs. Only at 7000 did the single plane Victor Jr finally show an advantage. This bears out a common trend. Single plane intakes tune well at high RPM, dual planes can tune well at lower RPM.

The Victor Jr's runners are isolated from heat sources, which keeps In Port Tmp (intake port temperature) lower than with the Performer intake. In Port Tmp varies from 109 -71 degrees where the Performer (255 CFM carb) varies from 133-103 degrees. That's 25 to 30 degrees cooler to keep the charge more dense.

Figure 4.8 Performance with Holley 500 2 barrel and Victor Jr Single Plane

Click on Graph button or Graph menu item to produce graph shown in Figure 4.9.

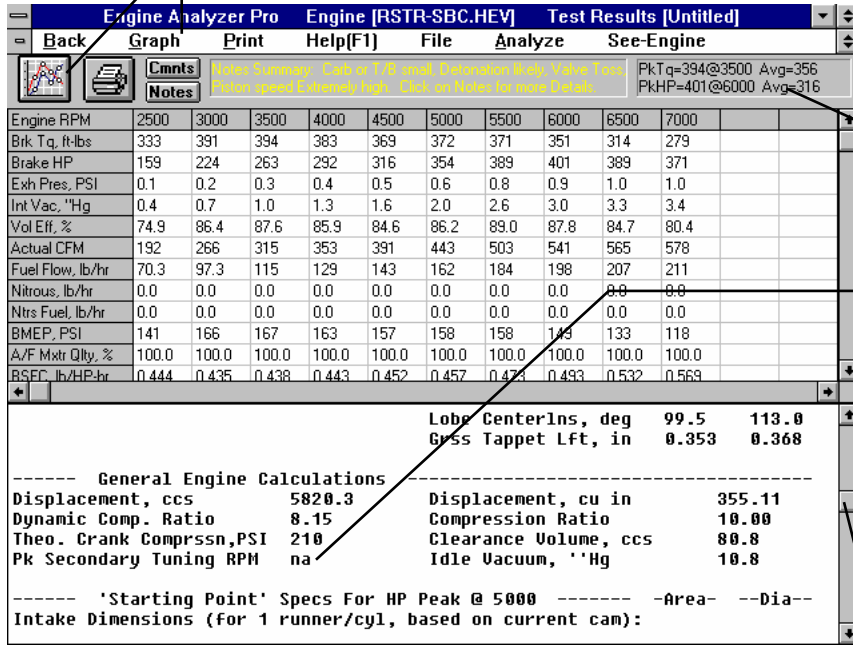

Performance Summary shows huge increase in Peak and Average torque and HP.

Click on slide bar to display more Special Calculations. Here is where the RPM for Peak Secondary Tuning is displayed. With the Dual Plane Performer intake it showed 2724 RPM. Here it shows "na" because there is no secondary tuning with this Single Plane intake on a V-8 engine.

Slide Bar

Figure 4.9 Comparison Graph of Baseline Performance (last) with New Intake (current)

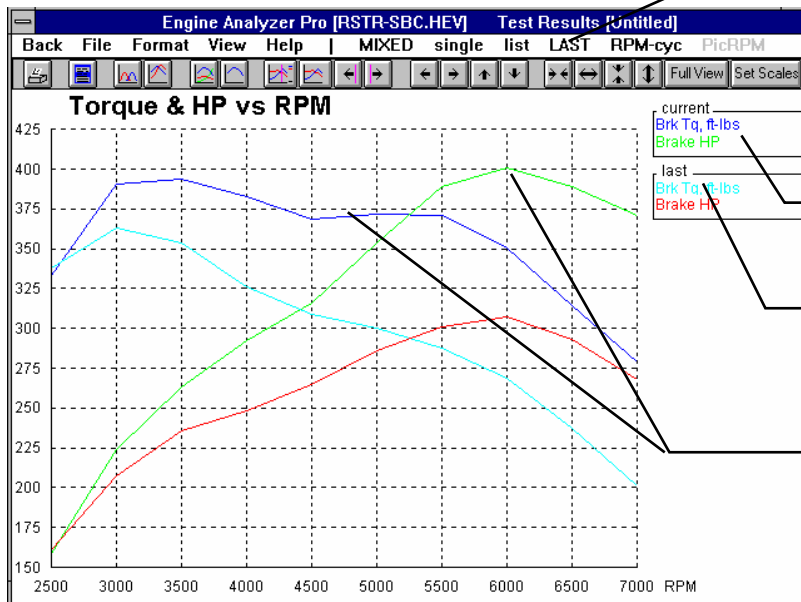

Be sure LAST is selected (printed in upper case). If not, click on last to have the program graph the last calculated performance (the baseline 350 2 barrel performance) with the current performance (500 2 barrel).

Current performance (500 2 barrel) color codes given here.

Last performance (350 2 barrel) color codes given here.

Current performance (500 2 barrel) torque and HP shows huge increase in performance at all RPMs except 2500.

Under the General Engine Calculations, notice the Secondary Tuning RPM is 2724 RPM with the dual plane intake. This tells you secondary tuning (low speed tuning) is present with the dual plane intake. The Secondary Tuning RPM is marked "na" with the single plane intake, saying no secondary tuning is present with this intake. See Appendix 3.

Higher RPM performance with the 400 CFM carb-single plane intake has increased for 2 main reasons: lower flow restriction producing less manifold vacuum, and a cooler intake charge. Very low speed performance has dropped somewhat due to a loss of secondary tuning.

Obtain a plot of the new data vs the old data by clicking on the Graph button or the Graph menu item. You should obtain a graph similar to that in Figure 4.9. If it does not contain the graph from the "Last" calculation (the 350 Holley performance), click on the "last" menu item at the right side of the menu bar.

The plot shows the high RPM performance improvement more dramatically than just quoting peak HP numbers. This modification showed a tremendous HP improvement over a broad RPM range.

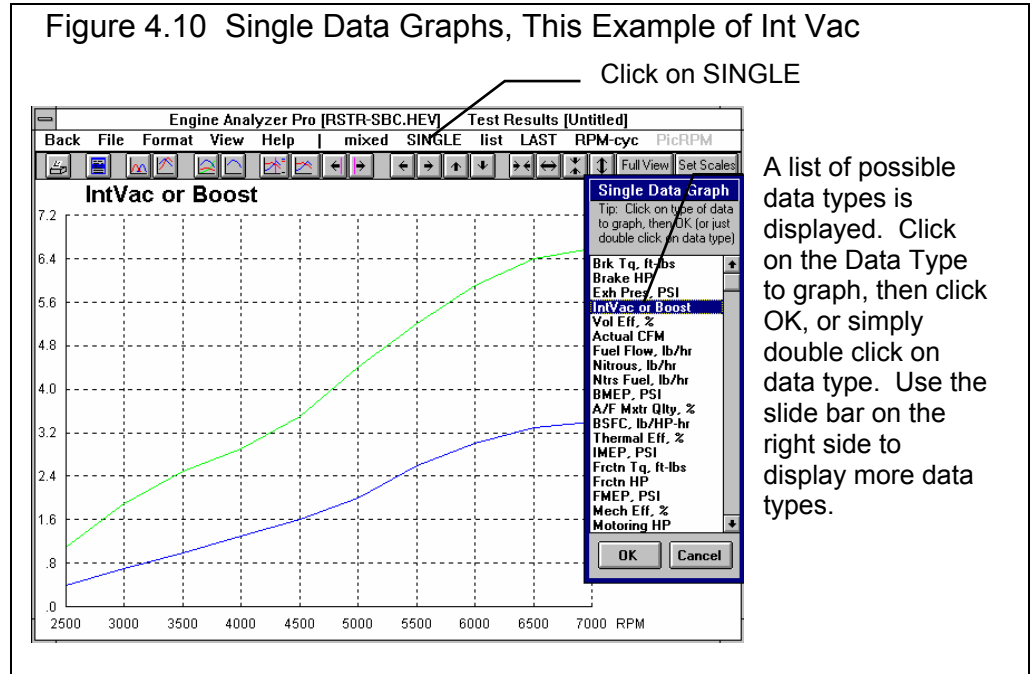

Conclusions:

- The Graph option allows you to create graphs of projected torque and HP vs RPM. The Graph option let you quickly compare performance between modifications and understand why performance has changed.
- The Projected Performance output allows you to estimate performance gains for various engine modifications.
- The calculated results contain a great deal of information. This data allows you to understand why performance changed as it did. These can also be easily graphed.

For Advanced Users:

Referring back to the results for this example, note the Primary Jet and Secondary Jet near the bottom of the estimated performance printouts. This is the recommended primary and secondary jet sizes for this engine with these carburetor specs. Since these carbs only had primary venturis, the Secondary Jet is blank in both cases.

(If your program is also showing Primary Jet as blank, you must select the Yes option for Fuel Calculations in the Intake System menu. If your program is showing very large numbers like 70 or so, you must go the Preferences menu at the top of the Main Menu, and change the Jet Recommendations to Jet Diameter, inches. Though Holley Jet # is more useful for many users, this example discusses actual jet areas so jet diameters are required in inches.)

A carburetor which is sized correctly for a certain engine should have approximately the same Primary Jet throughout the entire usable RPM range. You will notice that the program recommended .0774 at 3000 RPM which dropped to .0740 by 7000 RPM with the baseline 255 CFM carb. This need for a larger jet at low RPM is because the metering signal is weaker at low RPM and lower air flow. It also means that if 1 jet size is selected, the A/F will be leaner at low RPM than at high RPM, or:

The A/F delivered goes in the opposite direction of Primary Jet or Secondary Jet recommended.

For example, if you installed a .0774 jet, you would get 12.5 A/F at 3000, but it would be 9% too rich (11.5 A/F) at 7000 RPM. The equation squares the diameter because fuel flow is based on jet area and jet diameter.

$$\left[\frac{.0774}{.0740} \right]^2 = (1.046)^2 = 1.09 \times 100\% = 109\% \text{ or } 9\% \text{ too rich}$$

Repeat the steps in the first part of this example, this time paying close attention to the fuel metering effects. Retrieve RSTR-SBCHEV from the Engine Library and obtain baseline performance.

Now, when changing the 6 specs for the 400 CFM - single plane intake like done in the first part of this Example 4.1. Also change:

- The size of the Primary Venturi Diameter to 1.375" for the larger venturis in the 400 CFM 2 barrel. See Figure 4.13.
- Assume the 400 CFM carb has a similar power valve, venturi CD and air bleed % as the 255 CFM carb. Leave these 3 carb specs "as is".

Figure 4.11 Test Results for 500 2 Barrel Holley

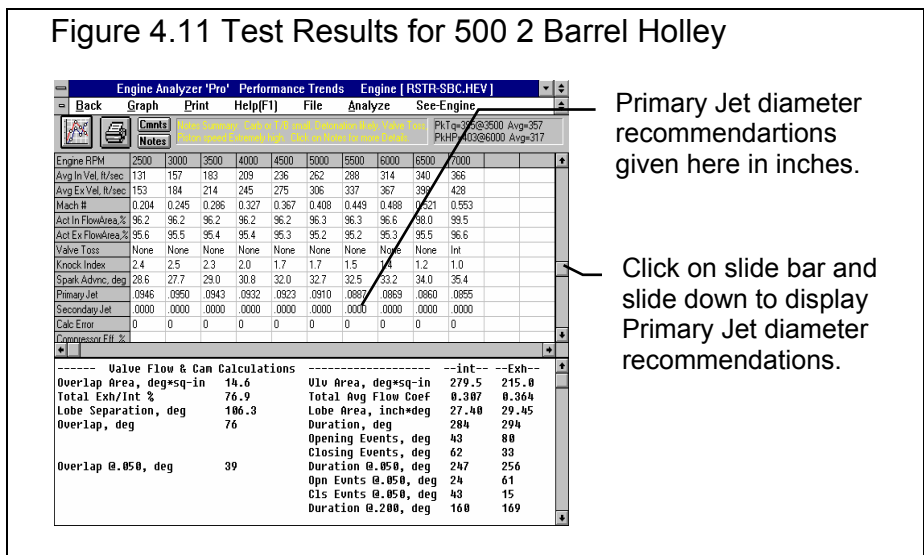

Primary Jet diameter recommendations given here in inches.
Click on slide bar and slide down to display Primary Jet diameter recommendations.

After calculating performance for the new intake, click on Graph, and select Single, then select Primary Jet to obtain a graph like Figure 4.12. As Table 4.1 shows, the 500 2 barrel shows a 23% variation in A/F from 3000 to 7000 RPM. It also shows that the 500 2 barrel requires a much larger Main Jet.

Finally, lets try a carb modification to reduce the change in recommended Primary Jet. Lets increase the air bleed % to 80% and recalculate performance. See Figure 4.13. You will notice you get the same performance data (Brk Tq, Brake HP, etc). However, Primary Jet has changed significantly. As shown in the Figure 4.12 you now need a much larger jet, well over .1000" diameter. However, the recommended jet size only changes 6% from 2500 to 7000 RPM. Theoretically, this carb setup on the 500 2 Barrel should give a more constant A/F throughout the RPM range than the 60% Air Bleed .

Table 4.1 Summary of Primary Jet Recommendations

Condition	Primary Jet at 3000	Primary Jet at 7000	% Area Change	A/F at 7000 *
350 2 barrel (255 CFM)	.0774	.0740	9%	11.5
500 2 barrel (400 CFM), 60% Air Bleed	.095	.0855	23%	10.2
500 2 barrel (400 CFM), 80% Air Bleed	.0113	.1023	18%	10.6

* Assuming the recommended Primary Jet @ 2500 was installed.

Figure 4.12 Single Data Graph of Primary Jet

350 vs 500 2 Barrel

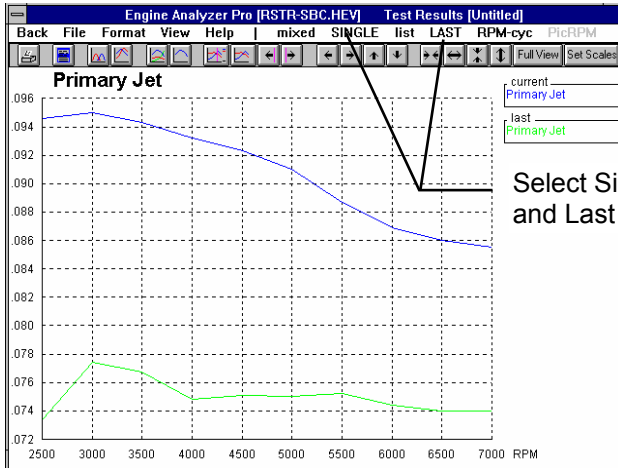

500 2 Barrel, 60% vs 80% Air Bleed

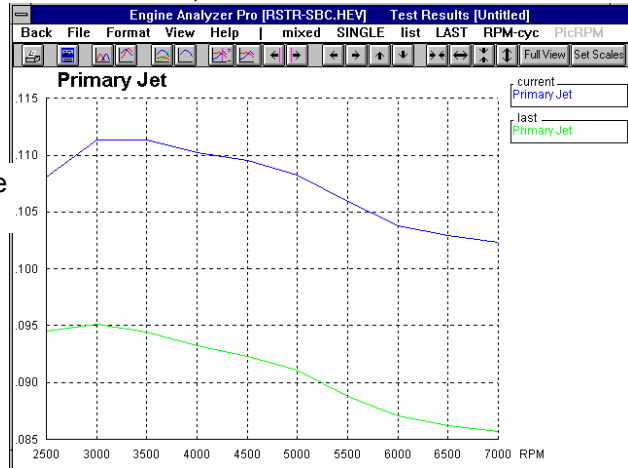
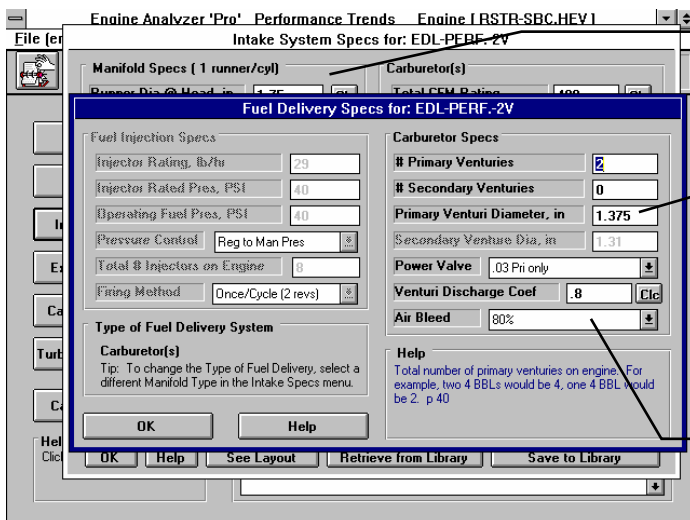

Figure 4.13 Fuel Delivery Specs Menu for 500 2 Barrel with 80% Air Bleed



Click on the See Specs button in the Fuel Delivery Calculations in the Intake System Specs menu to display this menu.

Change Primary Venturi Diameter to 1.375 for Holley 2 Barrel

Select 80 % air bleed from combo box

Conclusions:

- The Engine Analyzer Pro includes features to simulate a simple carburetor to estimate required jet sizes.

Notes on Carb Specs:

Some carb specs are easy to obtain or measure, like Primary Venturi Diameter. Others are more difficult, like Venturi Discharge Coef, which is not generally available from carb manufacturers but can be obtained from flow bench tests. See Sections 2.9.13 and 2.9.9.2.

However, the Air Bleed % is a number which can only be determined after all other carb specs are set correctly. Then you must Calculate Performance and see what Primary Jet and Secondary Jet are recommended. If they match the jet sizes you are currently using, and what you are using gives good performance on the actual engine (12.5 A/F), then Air Bleed % is set approximately correct. If the program recommends larger jets than you are using, you should reduce the Air Bleed %, and vice versa.

Because these specs are difficult to determine, the Primary Jet and Secondary Jet should only be used to show trends. Like in this example, switching to the 400 CFM carb showed the need for large jets at low RPM. It also showed the trend for Primary Jet to increase with more Air Bleed %.

Note: The Engine Analyzer Pro assumes the primary and secondary Venturi Discharge Coef and Air Bleed % are the same. However, for many carbs, this is not true. Therefore, the actual carb may require different Primary and Secondary Jets, even though the program predicts the same size jets.

Example 4.2 Installing Hydraulic And Solid Lifter Camshafts

Features Introduced (and suggested background reading):

- Evaluating Valve Flow & Cam Calculations and General Engine Calculations output (Section 2.8.2)
- Changing Calculation Conditions (Section 2.8.1)
- Specifying Cam Lift Files for cam specs (Section 2.6.1)
- Specifying graph axes scales with the Set Axes graph option (Section 3.4)

New Cam/Valve Train Specs inputs and features have been added or expanded in later versions. See Appendices 9 - 13 on pages 235-312 for more updated info.

More than any other single engine modification, the camshaft determines the engine's "personality", from a low speed "stump puller" to a high revving, Formula 1 racer. Its then no surprise that a great deal of the Engine Analyzer Pro's calculations center around the cam profile and timing. To investigate these calculations we will simulate installing a solid camshaft and a hydraulic camshaft in the restricted small block Chevy.

To eliminate some complications and save considerable calculation time, we will turn Off Valve Train Dynamics. This will eliminate the valve train weights and spring forces from the calculations. (Valve Train Dynamics do have an effect on performance. Dynamics will be investigated in "For Advanced Users".)

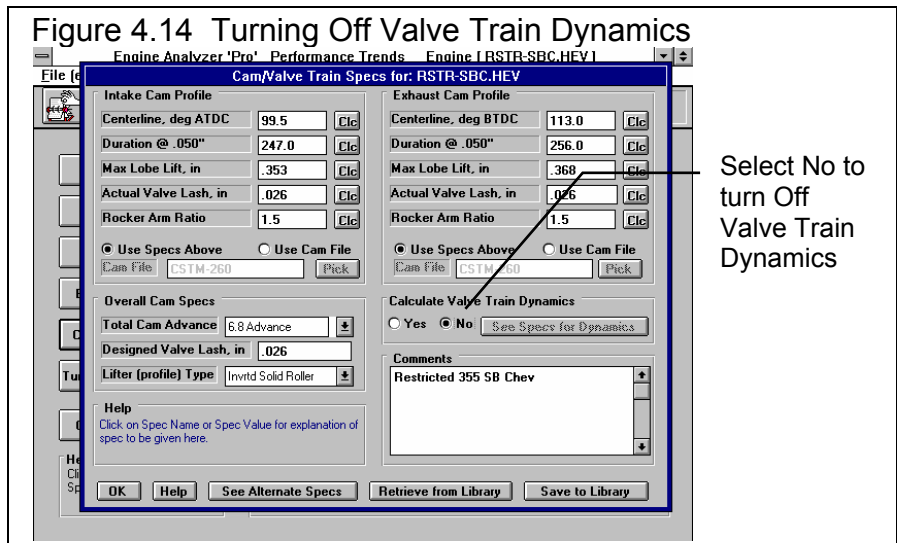

First, retrieve a fresh copy of the RSTR-SBCHEV from the Engine Library by clicking on the Retrieve button as shown in Example 4.1. Then we will go into the Cam/Valve Train menu and select No for Calculate Valve Train Dynamics. See Figure 4.14. Now all specs of valve train weights and spring rates are ignored in the calculations. Click on OK to return to the Main Menu.

As with any engine modification, you first need to obtain a baseline performance test, with the engine "as is". This will be slightly different than the performance calculated in Example 4.1 because we have turned Off Valve Train Dynamics.

Click on the Run/HP button at the top of the Main Menu, which is a short cut to calculating performance. Once performance calculations are done, click on the File menu item in the Menu bar at the top and select Save Current Test Results to Disk. This time we will save the baseline test results to disk so we can quickly recall them at any time in the future. See Figure 4.15. The menu for saving test results will appear as shown in Figure 4.15. Enter a name like RS355BAS to indicate a Baseline test for a Restricted 355 cubic inch engine. Fill in descriptive info in the Comments section as this will be displayed in the future when you go to retrieve these results in the future. Be sure to mention that Valve Train Dynamics were turned Off. (See Section 3.6 for

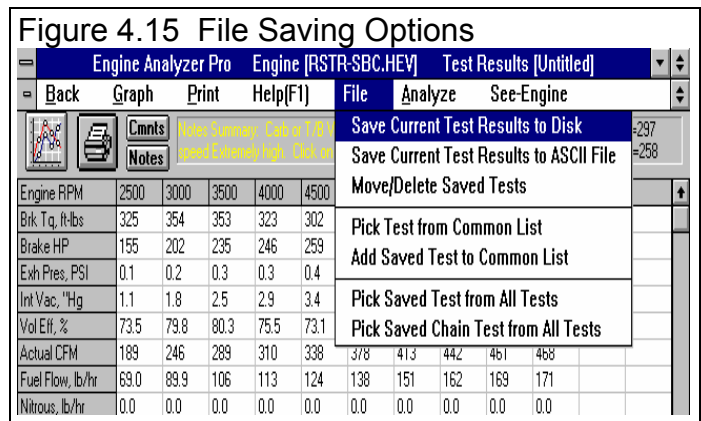

more options for saving test results, like creating a separate directory for all these tests, or moving or renaming test files.)

Now that the baseline test results have been save, return to the Main Menu (clicking on Back or pressing <Esc>). Now, let's install and check performance for 2 different camshafts. One cam is listed in a catalog with typical cam specs. The other cam is one you have used in another engine, and have measured using Performance Trends' Cam Analyzer. The Cam Analyzer produces a Cam Dr data file from dial indicator and degree wheel measurements. Table 4.2 shows the specs for these 2 cams and the original cam.

You will notice that cam grinders for the original cam and hydraulic cam do not give similar specifications, and that some of the hydraulic cam's do not match the specs of the Pro's Cam/Valve Train menu. Fortunately, the Pro has an input menu for Alternate Specs where these specs can be entered directly to make the necessary conversions.

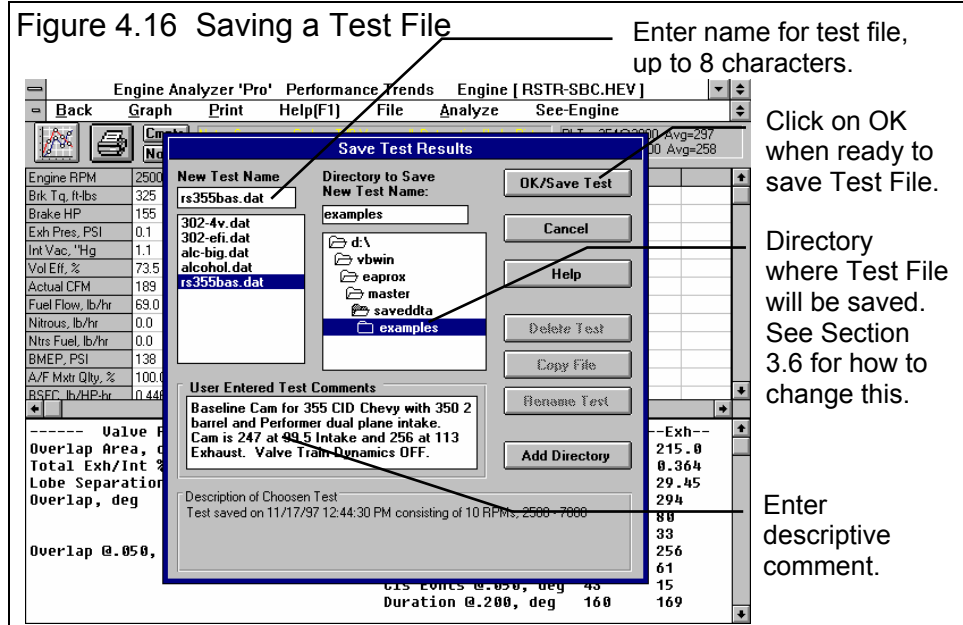

Table 4.2 Cam Specs from Catalog (except for Solid)

Catalog Specs	Orig. Inverted Flank Roller	Hydraulic Roller	Solid Inverted Flank Roller
Int. Open @ .050" Lift		7.5	file
Int. Close @ .050" Lift		47.5	file
Int. Recommended Valve Lash	.026	Hyd	.026
Int. Gross Lift @ Tappet	.353		file
Int. Gross Valve Lift		.48	file
Int. Duration @ .050" Lift	247		file
Int. Advertised Duration		290	file
Int. Lobe Centerline	99.5		110
Int. Valve Lift (1.5 Rocker Ratio)		1.5	
Exh. Open @ .050" Lift		52.5	file
Exh. Close @ .050" Lift		12.5	file
Exh. Recommended Valve Lash	.026	Hyd	.026
Exh. Gross Lift @ Tappet	.368		file
Exh. Gross Valve Lift		.51	file
Exh. Duration @ .050" Lift	256		file
Exh. Advertised Duration		300	file
Exh. Lobe Centerline	113		110
Exh. Valve Lift (1.5 Rocker Ratio)		1.5	

Hydraulic Cam:

Install the hydraulic cam by clicking on Cam/Valve Train menu. See Figure 4.15. In this menu, first select the correct Lifter (profile) Type. In this case it is an aftermarket hydraulic roller cam. Most aftermarket cams are more aggressive than production cams, so select Agr Hyd Roller. This spec is critical as it first tells the program if the lifters are Hydraulic or Solid, and secondly tells the program what to assume for ramp rates for the given duration and lobe lift.

Figure 4.17 Hydraulic Cam Specs in Alternate Cam Specs Menu

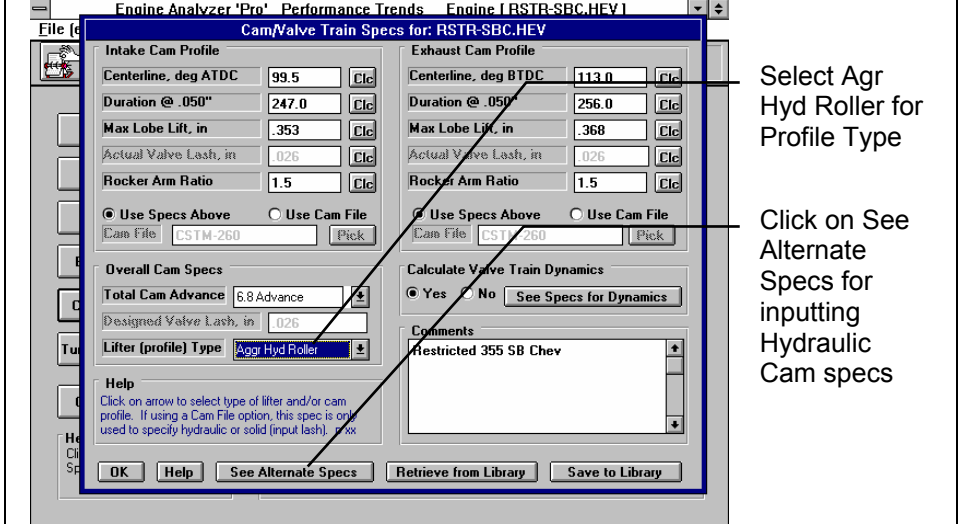

Select Agr Hyd Roller for Profile Type

Click on See Alternate Specs for inputting Hydraulic Cam specs

Then click on See Alternate Specs button at the bottom of this menu. The hydraulic cam's cam grinder gives opening and closing events at .050" so type them in. Gross Valve Lifts given by the cam grinder to obtain the Max Lobe Lift. Rocker Arm Ratios were already set to the correct 1.5 which this cam grinder uses for advertising Gross Valve Lift. If this were not the case, you would have to enter the rocker arm ratio used by the cam grinder (usually 1.5 for small block Chevys). Then once Max Lobe Lift was calculated from the cam grinder's assumed rocker arm ratio and Gross Valve Lift, you could enter the actual Rocker Arm Ratio you were using on the engine. The Alternate Cam Specs menu should look like Figure 4.16. Click on OK and return to the standard Cam/Valve Train Specs menu.

Figure 4.18 Alternate Cam Specs Menu

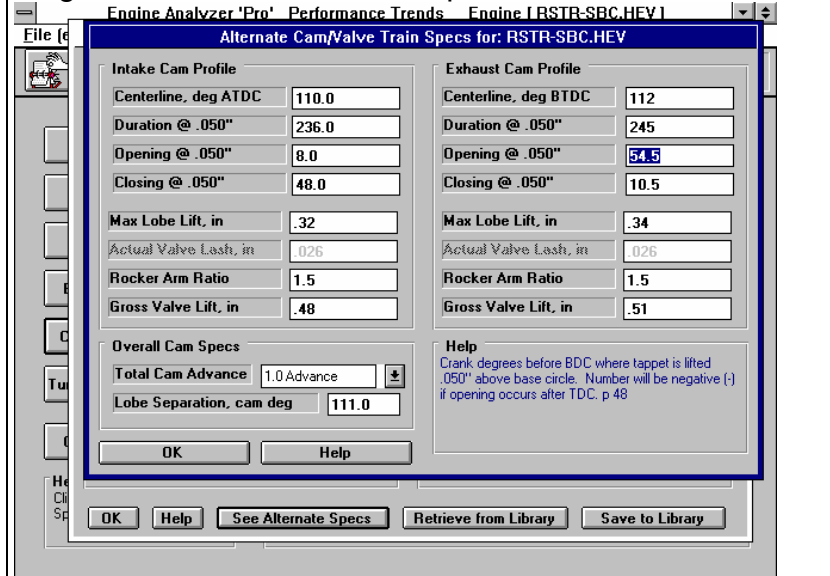

Calculate performance and save these results as a Test File under the name RS355HYD to denote it as a hydraulic cam. We do not need to plot the data now because the tests results have been saved to disk.

Tip: When the menu of Figure 4.16 appears, click on RS355BAS.DAT in the list of test files. This loads in this files name and comments. Then you can just make minor modifications rather than retyping the entire name and comments.

Solid Cam, from Cam Dr File:

This Solid Lifter cam is one where we have tappet lift data at every 2 crank degrees (every cam degree) saved in a data file. This particular file was created by Performance Trends' Cam Analyzer, and looks much like a file created by Quadrant Scientific's Cam Dr (tm) system. The name for the data file is CSTM-260 which has data for both the intake and exhaust lobe. This file describes the cam lobe more accurately than just using the Pro's standard profile based on .050" events, maximum tappet lift and an estimated profile type.

Figure 4.19 Selecting a Cam File

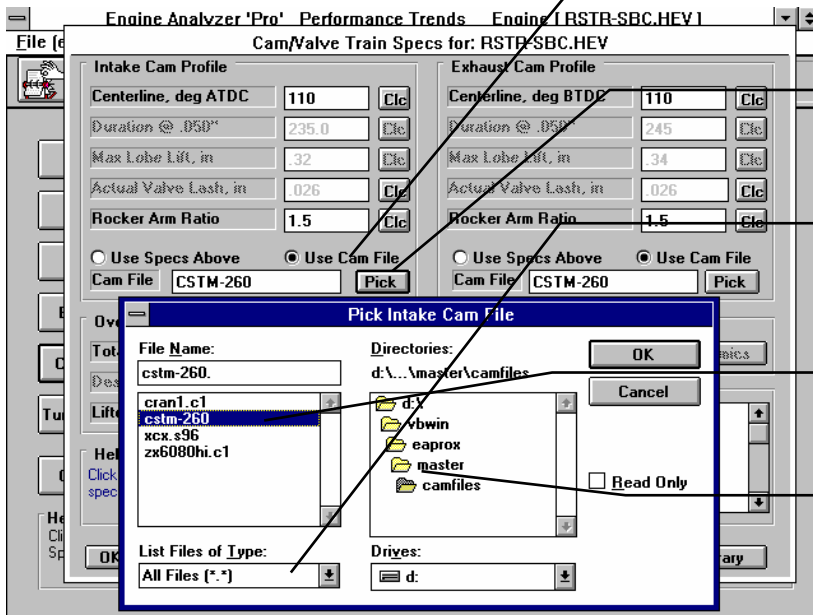

1. Select Use Cam File to use Cam Dr file from Cam Analyzer
2. Click on Pick button to display screen to pick cam file from disk.
3. Choose All Files (*.*) to display all files in the CAMFILES default directory.
4. Click on CSTM-PRO to select this file, then click on OK
5. If you need to, click here to choose a different directory where the cam file may be stored. **This is not required for this example.**

Return to the Cam/Valve Train menu, select the Use Cam File option for both the intake and exhaust. Then click on the Pick button to get the screen shown in Figure 4.19. Follow the instructions outlined in Figure 4.19 and you should get CSTM-260 as the Cam File for both the intake and exhaust. You will notice that several specs have become disabled when you select the Use Cam File option.

Figure 4.20 File Options in Graph Screen

Select File then Add Saved Test to Common List. **You can only graph saved tests which are in the Common List.**

Select the 3 saved RS355 tests one at a time, then click on Add to List and Select for Graphing. It will ask you for an RPM to graphing cycle data. Select 6000 RPM for each test.

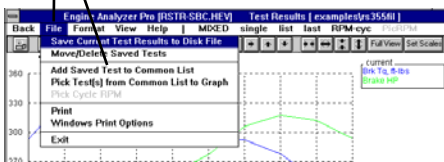

Your comments appear here to remind you of what this test was for.

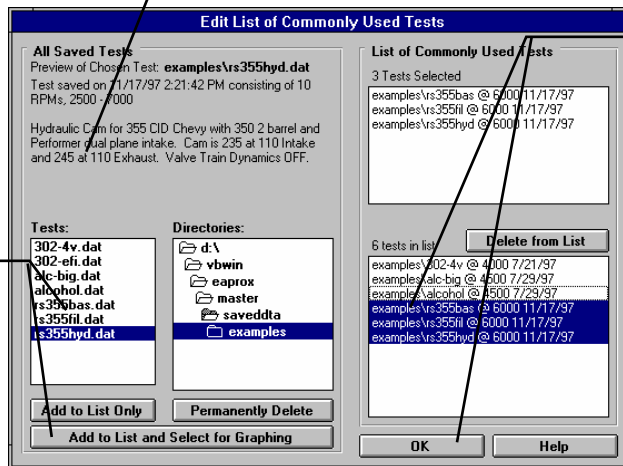

Select (highlight) only the 3 RS355 test files for graphing. They will appear in the Selected List at the top. Then click OK.

You must make some additional changes to the Cam/Valve Train specs. First, click on Profile (lifter) Type and select any of the Solid types. This is to tell the program that it must let you specify an Actual Lash. Then type in .026 for the Actual Lash for the intake and exhaust. Also type in the Centerlines of 110 for both the intake and exhaust.

Calculate performance and save this test file as RS355FIL to denote it as using a cam file to specify the cam specs. Now for the interesting stuff. Lets compare these 3 test files which have been saved. After saving the test file, click on the Graph button. Unlike Example 4.1 where we only compared the "current" results with the "last" results, **we are going to compare 3 tests at once. This can only be done by saving test files to disk as we have done here.**

At the Graph screen, click on File, then Add Saved Test to Common List as shown in Figure 4.20. When finished with the directions in Figure 4.20, click on OK. Back at the Graph Screen, click on LAST if it is not already selected to get the graph of Figure 4.21.

The Hydraulic cam shows lower performance for all RPMs, which is to be expected. The original cam shows more low RPM torque and the CSTM-260 cam shows more high RPM HP.

Figure 4.21 Performance Comparison of 3 Cams

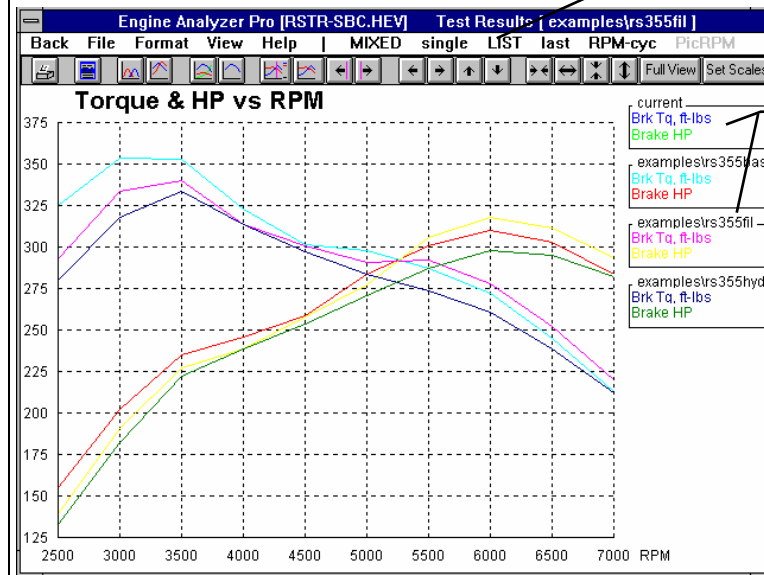

Click on LIST to graph files from Common List.

Note that current is the same as RS355FIL data.

Figure 4.22 Valve Lift Comparison

Click on RPM-cyc to switch to Cycle Data graphs. Then select MIXED and choose the Saved Graph Pattern of Int & Exh Valve Lift and click OK.

Click on Set Scales, then change the Maximum X Axis value from 900 to 630 in this menu. This will expand the graph and show better detail as shown here.

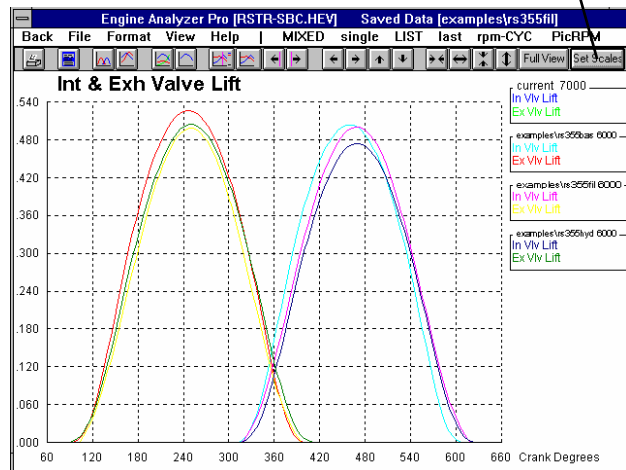
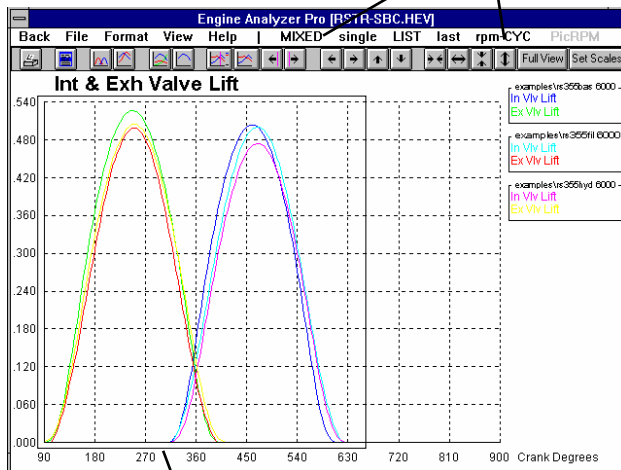

To expand the X Axis, you could have also clicked and dragged a box of the area you wanted expanded to fill the entire graph as shown here. Position the mouse pointer in the upper right corner of the area, hold down the left mouse button and drag the mouse to the lower left corner of the area. An outline box will be drawn. When the desired area is enclosed, release the mouse button. (The cursor must be turned Off and do not start the box close to a graphed data line or you will turn On the cursor instead of drawing a box.)

Once you have these 3 files loaded into the Common List, it is very easy to make comparison graphs of most anything. Figure 4.22 shows a comparison of Valve Lift for the 3 cams. Although the valve lifts don't look that different, the engine can tell the difference.

- The gentler ramps of the hydraulic cam (less lift for about the same duration) show a performance loss at all RPMs.
- The later intake closing of the CSTM-260 cam file cam helps top end HP and hurts low end torque.

Tip: The Cycle Data of Int & Exh Valve Lift shown in Figure 4.22 does **not** change with RPM. Therefore we did not have to be careful about using the same RPM for our comparisons between the different cams. If we graphed Cycle Data that **did** change with RPM like Cylinder Pressure, Port Pressures, and most any other Cycle Data, we would have to pay attention to the RPM we chose when we added these Test Files to the Common List.. **You can add the same test file to the Common List many times, each time selecting a different RPM.** This way you can compare Cycle Data for most any RPM from most any saved Test File.

Saving a Component File

From the Graph screen, click on Back, then at the Test Results screen click on Back. Open up the Cam/Valve Train menu. Notice that the current name of the Cam is RSTR-SBC.HEV and the comments are "Restricted 355 SB Chev". First change the comments to describe this cam, say "Ultradyn 260 deg, 110 lobe centerlines straight up, using Cam Analyzer Cam Dr file".

Then click on Save to Library. You are first asked if you want to save the current cam specs to the current component name of RSTR-SBC.HEV. Answer No since you may want to use the original cam specs in some other engine at some time. The program then presents a screen for you to enter a new name for these cam specs. It defaults to the current name of RSTR-SBC.HEV so you can use it or make minor modifications to it if you want. We want to change it completely so use the delete key or backspace key to erase it. Then type in UD260-FIL for the new name and click on OK. See Figure 4.23. The program will say it will have to modify the name to UD260-FI.L, but answer that that is OK.

You have now added a new cam and valve train to the Cam Library. Click on the Retrieve from Library and you will see UD260-FI.L in the list.

Even though only the cam specs were changed in this test sequence, you could have saved all the engine specs to a new Engine File. First you would have modified the engine comments at the Main Menu to accurately describe this engine with the new cam. Then you would have clicked on the File (engine) menu item at the Main Menu, then on Save As to give these engine specs a new name. You could also click on the Save button at the Main Menu. See the Tip in Figure 4.23.

Figure 4.23 Saving Engine or Component Files

Tip: To save an entire Engine File (**not** a component file), click on File then Save As; or click on the Save button (shown here somewhat hidden by the Cam/Valve Train menu).

Modify comments to accurately describe these specs before saving.

Click here to save a Component file

Change Valve Lash

To illustrate the flexibility of the Engine Analyzer Pro, change the valve lash on the Solid Lifter camshaft on both intake and exhaust to .020". Calculate performance and do a graph as shown in Figure 4.24. Remember that now we have 4 conditions and the Current data is the CSTM-260 cam file with .020" lash instead of .026" lash.

Since this is just an interesting test, and you are not really interested in doing this on the real engine, we'd recommend that you do not save it as a Test File. These results at .020" will be gone once you've made a new calculation. Since the hydraulic cam performed poorly, you may also want to delete it as a Test File. To do this click on File, then Move/Delete Saved Tests at the Test Results screen or Graph screen. See Section 3.6 for more details.

Do not get in the habit of saving all test results. Also, once you know certain test results will no longer be of interest, delete them. Test Files are very large and you will use up a lot of disk space by saving several. It is also more confusing to find Test Files when you have saved so many.

Calculate performance after setting lash to .020" and graph the results. To get the Torque and HP graph shown in Figure 4.24, click on rpm-CYC to select RPM Data Graphs (will now be displayed as RPM-cyc). If you do not then get torque and HP vs RPM, click on MIXED and select Tq & HP vs RPM from the Saved Graph Patterns. If LIST is not printed in all upper case, click on it. Now you should get the first graph of Figure 4.24 showing all 4 conditions you have tested.

This graph can be somewhat confusing with all 8 different graph lines. To simplify it, click on LIST to display the Common List of Test Files you could graph. Then click on RS355BAS.DAT and RS355HYD.DAT to "de-select" them for graphing. Only the RS255FIL.DAT Test File is selected from the list. Click on the OK button to produce the second graph in Figure 4.24 which compares the RS355FIL Solid Cam's performance with the original .026" lash to the .020" lash.

Figure 4.24 Graphs with Solid Cam at .020" Lash (called "current" in graph)

Click on rpm-CYC, LIST and MIXED (as necessary) to produce Torque & HP vs RPM for all 4 cam tests.

De-select (click on) RS355BAS and RS355HYD to unhighlight them. Only RS355FIL is highlighted. Then click OK button. Only RS355FIL will be graphed with the current test results of RS355 FIL with .020" lash.

Move cursor left & right with these buttons.

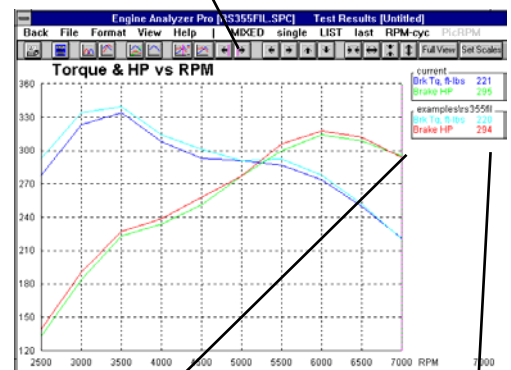
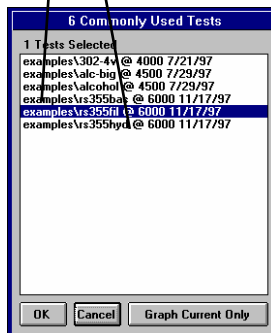
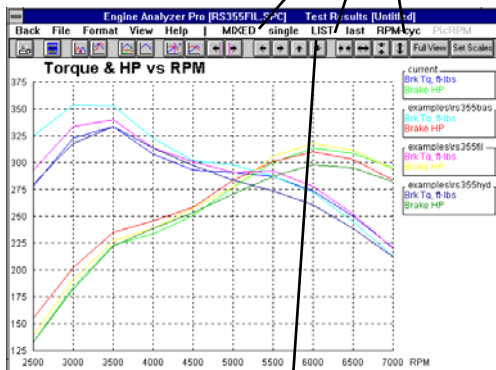

Click on LIST to display the Common List shown between the graphs.

Click on HP data at 7000 RPM to bring up the cursor (vertical pink line). The exact value of each graph line at 7000 RPM is displayed in the legend.

Cursor values show the .020" lash cam shows loss at all RPMs except a 1 HP improvement at 7000 RPM.

Click on the Cursor buttons or the graph line at some data point to display the cursor. Notice that the exact value of the graph lines at the cursor is displayed in the legend. Move the cursor left or right by clicking on the left or right cursor buttons. See Figure 4.24. Notice that the .020" lash cam shows a performance loss at all RPMs except 7000 RPM where it shows a modest 1 HP improvement.

Table 4.3 shows comparisons between various calculated outputs for all 4 camshafts setups, baseline, hydraulic, solid lifter and solid lifter with .020" lash.

Table 4.3 Comparison of 4 Cams

Condition	Stock	Hydraulic	Solid	Solid .020" lash
Int Close @ .050"	43	48	57	57
Int Closing	62	78	77	81
Peak Brk Tq	354 @ 3000	334 @ 3000	340 @ 3500	334 @ 3500
Peak Brake HP	310 @ 6000	298 @ 6000	318 @ 6000	314 @ 6000
Avg Brake HP	258	246	256	252
Overlap Area	14.6	13.5	13.4	15.3
Idle Vacuum	11.2	11.8	11.8	10.9
Valve Area, sq in*deg	278.0 / 215.0	271.4 / 214.9	283.7 / 204.8	288.6 / 208.1
Total Exh/Int %	77.3	79.2	72.2	72.1
Lobe Area	27.40 / 29.45	25.84 / 28.29	27.63 / 26/52	28.24 / 27.11
Cranking Compression	210	173	174	164

Discussion of Table 4.3:

- Cam timing and profile affects nearly every aspect of engine performance.
- In general, torque dropped as the actual Int Closing increased or the cam closed later in the cycle. HP did not always increase due to other factors like total Valve Area which affect high RPM flow capability. If this engine was not restricted by the small carb, this trend could be very different.
- Cranking Compression dropped with increased (later) intake closing. That's because the piston has pushed more fresh charge back past the intake valve before the valve closes. This traps less air in the cylinder causing lower compression pressure and lower torque levels at low speed.
- Note that Total Exh/Int % is affected significantly by cam timing. Proper selection of a camshaft can help make up for a poor flowing exhaust or intake port and bring them into balance.
- Valve Areas increased with each "more aggressive" cam and with reduced valve lash. Remember, we are not changing valve sizes or valve Flow Coef. This is entirely due to cam profile.
- Valve lash has an impact on projected performance and all other calculated results. In general, reducing valve lash produced a "bigger" cam (all cam measurements, like Lobe Area, Valve Area, etc increased). However, the engine did not like the increase until very high RPM.

Conclusions:

- Cam timing and lash affect nearly every aspect of engine performance.
- You can save Test Results in files for recall at any time for comparisons to other test results in graphs.
- You can save Engine specs or Component Specs in files for use building new engine combinations in the future.
- You should become familiar with all calculated results. They will help you understand why performance changes with engine modifications.
- The Engine Analyzer Pro has several graphing options for you to compare RPM Data or Cycle Data between runs or between different RPMs. This allows you to quickly spot trends and understand why they occurred.

For Advanced Users, Valve Train Dynamics:

First, retrieve the RSTR-SBCHEV file from the TOTAL ENGINE Library and calculate performance for the original cam.

Repeat the process done in this example except be sure to set the Calculate Valve Train Dynamics option in the Cam/Valve Train menu to Yes. This tells the program to simulate the bending and "tossing" which can occur in the actual valve train.

You will notice the torque and HP are different than with the Calculate Valve Train Dynamics option set to No. You will also notice "Valve Toss" listed in the Notes Summary section at the top of the test results. This is highlighting the fact the program predicts this combination may toss at one of the RPMs run. Click on the vertical scroll bar scroll down to the bottom of performance results. There you will see Valve Toss, with "none" at all RPMs until 7000 RPM, where a "Int" is written.

Figure 4.27

Click on Notes button for more explanation of Notes Summary.

Valve Toss pointed out in Notes Summary

Click and drag slide bar down to get to bottom of test results to see Valve Toss output.

Program also shows Dynamic Intake Flow Area increasing at 7000 RPM, from about 96% up close to 100% due to Valve Toss.

Program shows Valve Toss is likely on the Intake side at 7000 RPM.

Engine RPM	2500	3000	3500	4000	4500	5000	5500	6000	6500	7000
In Tun Pres, PSI	0.4	0.5	0.6	0.6	1.2	2.2	2.7	3.2	3.3	3.8
Avg In Vel, ft/sec	132	158	184	211	237	264	290	316	343	369
Avg Ex Vel, ft/sec	153	184	214	245	275	306	337	367	398	428
Mach #	0.205	0.246	0.287	0.328	0.369	0.410	0.451	0.490	0.523	0.556
Act In FlowArea, %	96.1	96.2	96.2	96.2	96.2	96.3	96.3	96.6	98.1	99.5
Act Ex FlowArea, %	95.6	95.5	95.4	95.4	95.4	95.3	95.4	95.4	95.6	96.9
Valve Toss	None	None	None	None	None	None	None	None	None	Int
Knock Index	2.5	2.4	2.0	1.6	1.4	1.3	1.2	1.0	0.9	0.7
Spark Advnc, deg	28.5	27.8	29.3	31.6	32.9	33.9	34.2	34.8	35.6	36.8
Primary Jet	.0733	.0774	.0767	.0748	.0751	.0750	.0752	.0745	.0740	.0740
Secondary Jet	.0000	.0000	.0000	.0000	.0000	.0000	.0000	.0000	.0000	.0000
Calc Error	0	0	0	0	0	0	0	0	0	0

Valve Flow & Cam Calculations		int	Exh
Overlap Area, deg*sq-in	14.6	278.0	215.0
Total Exh/Int %	77.3	0.305	0.364
Lobe Separation, deg	106.3	27.40	29.45
Overlap, deg	76	284	294
		Opening Events, deg	43
		Closing Events, deg	62
Overlap @.050, deg	39	Duration @.050, deg	247
		Opn Evnts @.050, deg	24
		Cls Evnts @.050, deg	43
		Duration @.200, deg	160

For further detail of valve train dynamics at 7000, let's plot the valve train motion. Click on the Graph button and follow the instructions shown in Figure 4.28. Figure 4.29 shows readings at the maximum Pushrod Force point by using the cursor. Explanations of Figure 4.29 also point out general things to look for when looking at valve train dynamics graphs. As you can see the actual valve lift is quite a bit greater than the theoretical valve lift on the "slowing down" portion of the opening ramp. This graph confirms what the test results were showing, that there is Valve Toss on the intake side at 7000 RPM.

Figure 4.28 Obtaining Graph of Intake Valve Train Dynamics

1. At Graph screen, first be sure rpm-CYC has "CYC" in upper case to indicate Cycle Data is selected. If it is shown as RPM-cyc click on it to change it to rpm-CYC.

2. Click on MIXED to get the Mixed Data Graph Format menu.

3..Click on Use Saved Graph Pattern

5. Turn Off last and list as shown here.

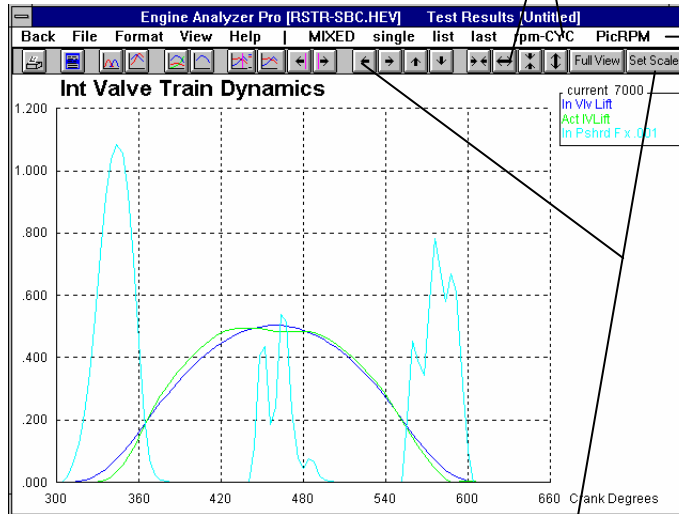
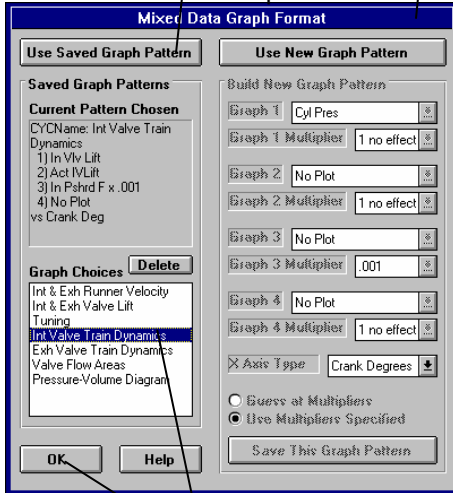

4. Click on Int Valve Train Dynamics to select it, then click OK

6. Change scales as necessary using any of these left 10 buttons to produce a graph with good detail as shown here

If necessary, click on PicRPM to select 7000 RPM for graphing.

Figure 4.29

Max pushrod force of 1.1 x 1000 or 1100 lbs on opening ramp. See legend for exact force.

Where Act IV Lift is less than In Vlv Lift, the valve train is bending, like here on the opening ramp.

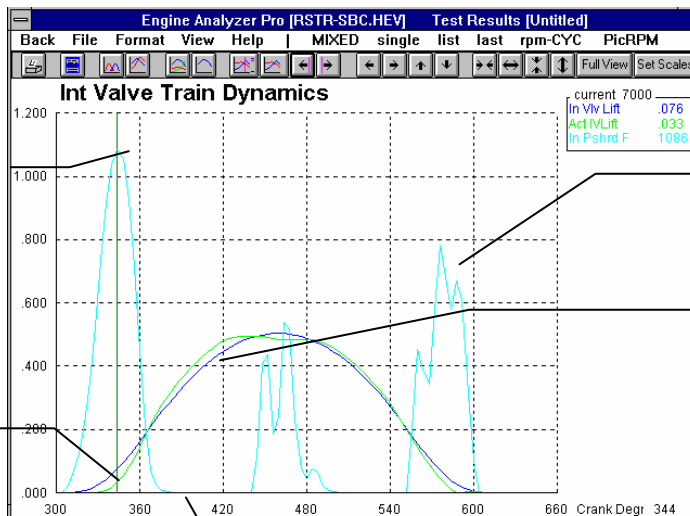

Legend shows pushrod force as 1086 lbs.

High pushrod force on closing ramp also.

Where Act IV Lift is higher than In Vlv Lift, the valve train is tossing, like here on the "slowing down" portion of the opening ramp.

Pushrod force goes to 0 when lifter "launches" off cam during valve toss.

You can actually determine the amount of bending or tossing by subtracting actual valve lift from the theoretical valve lift. For example, as shown in Figure 4.27 at the cursor at 344 degrees:

$$\begin{array}{rcl}
 & \text{In Vlv Lift} & = \quad .076 \\
 - & \text{Act IV Lift} & = \quad \underline{.033} \\
 & \text{Bending} & = \quad .043
 \end{array}$$

Repeat the calculations for the Hydraulic Cam and Solid Cam except with valve train dynamics On for each. A summary of these performance calculations and plots is contained in Table 4.4.

Note: The program must see valve toss (difference between Act IV Lift and In Vlv Lift) greater than a certain amount before it calls the condition Valve Toss.

Table 4.4 Performance with Valve Train Dynamics ON

Performance	Original	Hydraulic	Solid
Peak Brk Tq, Dyn ON	362 @ 3000	338 @ 3500	344 @ 3500
Peak Brk Tq, Dyn OFF	354 @ 3000	334 @ 3000	340 @ 3500
Peak Brake HP, Dyn ON	307 @ 6000	299 @ 6000	316 @ 6000
Peak Brake HP, Dyn OFF	310 @ 6000	298 @ 6000	318 @ 6000
Max Pushrod Force	1086	880	887
Called Valve Toss @ 7000	Yes	No	No
Maximum Toss, inches	.032	.009	.009

Table 4.4 shows the Hydraulic and Solid cam with lower torque levels than the original cam. However, they also showed lower pushrod forces, maximum toss and were not called Valve Toss by the program at 7000 RPM.

It appears that the original cam has more aggressive ramps and is designed to work at lower RPMs. For a restricted engine which has limited air to burn, the original cam makes good sense. It produces good power and torque at lower RPMs. However, the original cam's limited duration and tendency to valve toss at higher RPMs limits its RPM range.

The Solid lifter does make more peak HP, and would probably be clear winners at all higher RPMs with an unrestricted intake system. You may want to try this cam comparison again with an 850 CFM carb.

Table 4.4 also shows another common trend, that the engine produces more torque at low RPM with dynamics turned On and many times less high RPM HP. That's because the valve actually opens after and closes sooner than the cam would open and close the valve without dynamics. Look at Figure 4.29 and notice that the Act IV Lift line jumps up more quickly than the In Vlv Lift line on the opening ramp. The same happens on the closing ramp. The profile actually followed by the valve has approximately the same lift as directed by the cam, but less duration. This combination of giving approximately the same higher lifts but limiting the lower lifts generally makes more torque. However at high RPM where the engine needs all the breathing help it can get, any loss in valve lift limits air flow and therefore limit HP.

Conclusions:

- This restricted engine likes the original cam for performance, especially at lower RPM. However, at higher RPM it has a tendency to valve toss and produce high pushrod loads due to its aggressive acceleration rates.
- The Test Results will generally show more low RPM torque and less high RPM HP with valve train dynamics being simulated.
- The Engine Analyzer Pro allows you to investigate the complex workings of the engine's valve train.

A Couple of Tips:

Instead of recreating the cam specs in the Cam/Valve Train menu as done in the first part of this example, you could have retrieved each saved test file in the Common List from the Test Results screen as shown in Figure 4.30. Click on File, then Pick Test from Common List. Click on RS355HYD.DAT and click on OK. When asked if you want to use the engine specs which produced these results answer **Yes**. You have now retrieved the Test Results (**including cam specs**) for the Restricted 355 Chevy with the Hydraulic cam.

Answer No to the next question: "Do you want to save the current specs." Then return to the Main Menu, select Cam/Valve Train Specs and select Yes for Calculate Valve Train Dynamics. You will notice all the other Hydraulic cam's specs were reloaded properly. Recalculate performance to obtain performance for the Hydraulic cam with Valve Train Dynamics turned On.

Figure 4.30 Alternate way to Recreate Cam Specs for Testing with Valve Train Dynamics On

Retrieve saved Test File from Common List at Test Results screen.

Select Test File from Common List and then click OK.

Important: Answer Yes to whether engine specs should be retrieved also.

Do you want the engine specs [Bore, Stroke, Head Flow, Cam specs etc.] which produced these test results [Saved Data [examplesrs355hyd]] retrieved also.

They will replace the current engine specs for RSTR-SBC.HEV. If you answer Yes, you will then be asked if you want to save the current engine specs so they will not be lost.

Engine RPM	2500	3000	3500	4000	4500
Brk Tq. ft-lbs	305	341	344	316	305
Brake HP	145	195	229	241	261
Exh Pres. PSI	0.1	0.2	0.2	0.3	0.4
Inlt Vac. "Hg	0.9	1.6	2.2	2.6	3.2
Vol Eff. %	69.1	77.2	78.3	74.4	73.7
Actual CFM	177	238	282	306	341
Fuel Flow. lb/hr	64.8	87.0	103	112	124
				139	154
				166	173
				175	

Another feature which helps analyze valve train dynamics is the See-Engine screen shown in Figure 4.31. The See-Engine menu item is 2 options to the right of the File menu item highlighted in Figure 4.30. In the See-Engine screen you can watch the valves and piston move, watch port pressures and velocities. Table 4.4 showed Maximum Valve Toss, which is theoretical valve lift - actual valve lift. The See-Engine does this math automatically for you as shown in Figure 4.31.

Figure 4.31 See-Engine Feature to Determine Max Valve Toss

Minimum Piston to Valve clearance is shown here and is a great aid to engine builders.

Valve Toss and Valve Train Bending shown here. Cycle through all crank degrees (click on the Continuous button) to find the maximum values as shown in Table 4.4.

	Exhaust	Intake
Valve Angle	23	23
Inches from Valve to Head Surface	.08	.01
Valve Diameter	1.6	2.02
Piston to Valve	.402	.002
Min Piston to Valve	-.040	-.169
Valve Toss	.010	.032
Valve Train Bndng	.000	.000
Actual Valve Lift	.014	.372
Theo. Valve Lift	.004	.340

Note: This screen is not a substitute for checking clearances with clay! Clearances are based on a flat top piston and NO rod stretch. (Some dimensions not to scale. Click on Help button for more information.)

Example 4.3 Supercharging, Turbocharging & Nitrous Oxide

Features Introduced (and suggested background reading):

- Changing Turbocharger and Supercharger Specs (Section 2.7)
- Specifying nitrous oxide injection (Section 2.8.1)
- New results for turbo/supercharger performance (Section 2.8.2)

New Turbocharger inputs and features have been added or expanded in later versions. See Appendices 9 - 13 on pages 235-312 for more updated info.

Popular street "bolt on" performance modifications include nitrous oxide injection systems, superchargers and turbochargers. The Engine Analyzer Pro lets you simulate all 3 types of systems in detail.

For this street application, we will use the 302-4V Mustang engine. Retrieve the 302-4V from the Engine Library by clicking on the Retrieve button at the Main Menu. Calculate baseline performance and save these test results to a test file with the name of 302-BASE. In stock condition, the 302-4V makes 270 ft lbs @ 3200 and 210 HP @ 4800.

Turbocharger:

You first want to check the performance potential of the 302-4V with a turbocharger, so click on the Turbo/Supercharger button on the Main Menu, then select Turbocharger for type and click on View Specs. This opens up the Turbocharger menu shown in Figure 4.32. One way to simulate a turbo is to edit the turbocharger specs in this menu. The other way is to retrieve a set of specs from the Turbocharger Specs Library. Click on Retrieve from Library and then select TB302-AR.67 and click on OK. Then answer No to the "Save your (possible) changes..." question.

Back at the Turbocharger menu, you see the specs for this turbo. The single turbo is set up with Max Boost Limit = 8.8 PSI, indicating a boost control limit via a wastegate. It also has no intercooler. It draws air through the carb (carb before the turbo) rather than blowing through the carb. From the comments, you see this is a relatively small turbo, used on the first production Buick turbo V-6. With this single change, return to the Main Menu and calculate performance. Let's see how this performs on the production 302-4V.

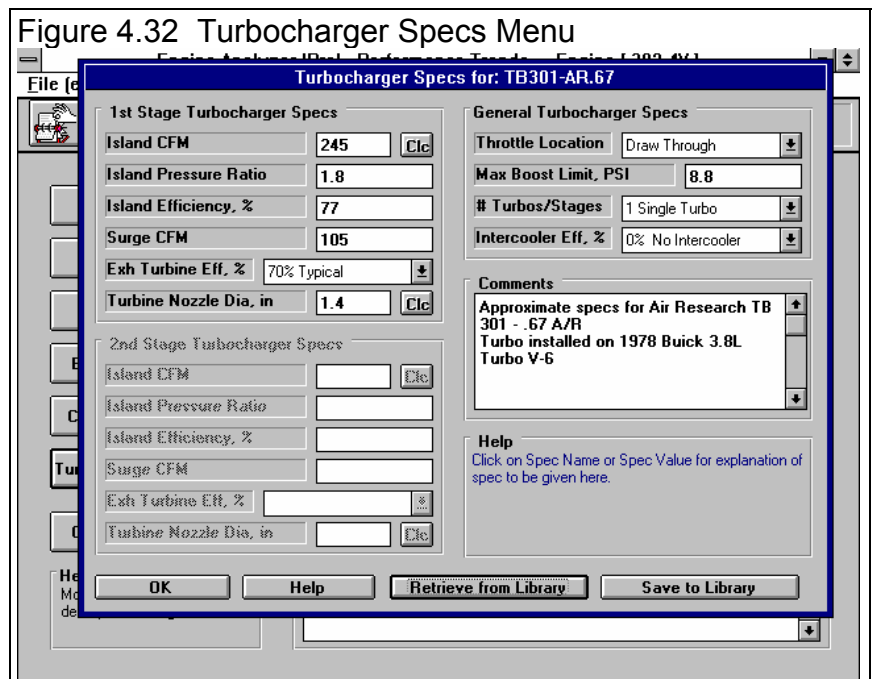

When performance has been calculated, scroll down through all the results. You will notice new outputs at the bottom of the Test Results as shown in Figure 4.33. These outputs deal only with turbocharger performance. For example, Wastetgt,% is more than 0 at several RPMs. This indicates the percent of exhaust the wastegate bypasses around the exhaust turbine, to limit boost to 8.8 PSI. These turbo parameters are explained on page 86.

Figure 4.33 Turbocharger Outputs for Turbo 302-4V

Engine RPM	2000	2400	2800	3200	3600	4000	4400	4800	5200	5600
Knock Index	3.6	3.7	4.6	4.4	4.1	3.8	3.3	2.9	2.5	2.1
Spark Advnc, deg	20.6	21.4	21.2	21.8	22.6	23.3	24.1	25.0	26.1	27.2
Primary Jet	.0726	.0725	.0711	.0765	.0765	.0764	.0763	.0761	.0761	.0760
Secondary Jet	.0907	.0905	.0889	.0952	.0952	.0951	.0949	.0948	.0947	.0946
Calc Error	0	0	0	0	0	0	0	0	0	0
Compressor Eff. %	62.7	65.0	70.5	65.8	60.9	56.0	51.5	47.2	43.6	40.5
Comprsr Pres Ratio	1.17	1.30	1.64	1.64	1.65	1.66	1.67	1.67	1.68	1.68
Compressor HP	2.4	5.2	13.5	17.5	21.5	26.1	30.9	35.7	39.9	44.1
Compressor RPM										
Roots Vol Eff. %										
Turbo Wasteg. %	0.0	0.0	0.0	7.1	9.3	10.0	10.2	8.0	6.2	4.0
Turbo Surgn. %	0.0	0.0	0.0	0.0	0.0	0.0	0.0	0.0	0.0	0.0

Valve Flow & Cam Calculations		int	Exh
Overlap Area, deg*sq-in	1.5	171.5	117.7
Total Exh/Int %	68.6	0.252	0.208
Lobe Separation, deg	114.3	20.39	19.91
Overlap, deg	42	274	267
		Opening Events, deg	22
		Closing Events, deg	71
Overlap @.050, deg	-20	Duration @.050, deg	211
		Opn Evnts @.050, deg	-9
		Cls Evnts @.050, deg	40
		Duration @.200, deg	111

It is difficult to see here, but Notes Summary is warning of "Detonation Very Likely" with turbocharger installed.

Knock Index well over 2 at all RPMs, indicating spark knock or detonation is very likely at all RPMs

Click and drag the slide bar down to display the turbocharger outputs.

Turbocharger outputs which describe how the turbocharger is performing, are shown here

Figure 4.35 is the approximate compressor map for this turbocharger, which you could obtain from the turbo supplier. The points on the map are the operating points for each RPM of the calculation. They are determined by plotting Actual CFM (not shown in Figure 4.33) and PR (as shown in Figure 4.33). These operating points lie to the right of the peak efficiency island. If they were closer to the efficiency island, Compressor Eff would be much higher. This indicates the turbo is *not* operating at its peak efficiency, and may be sized incorrectly. Since the operating points are at a higher CFM flow than the peak efficiency island, it appears that the turbo may be too small for this application.

Other points of interest include:

- This turbocharger provides a huge increase in torque, over 400 ft lbs at 2800 RPM.
- HP has increased to over 300 from 4000 to 5200 RPM
- As the Notes section points out, Knock Index is warning of possible knock or detonation. Scroll down to Knock Index in the results, and you see values from 21-4.6, indicating detonation is Very likely. This turbo would require either very high octane gas or significant spark retard. See For Advanced Users.
- Intake Vac is now reported as Boost in PSI because the engine is now turbocharged. This means a positive boost pressure exists in the intake manifold. Also notice that boost gets up to

Figure 4.34 Turbocharger Performance vs Baseline 302-4V

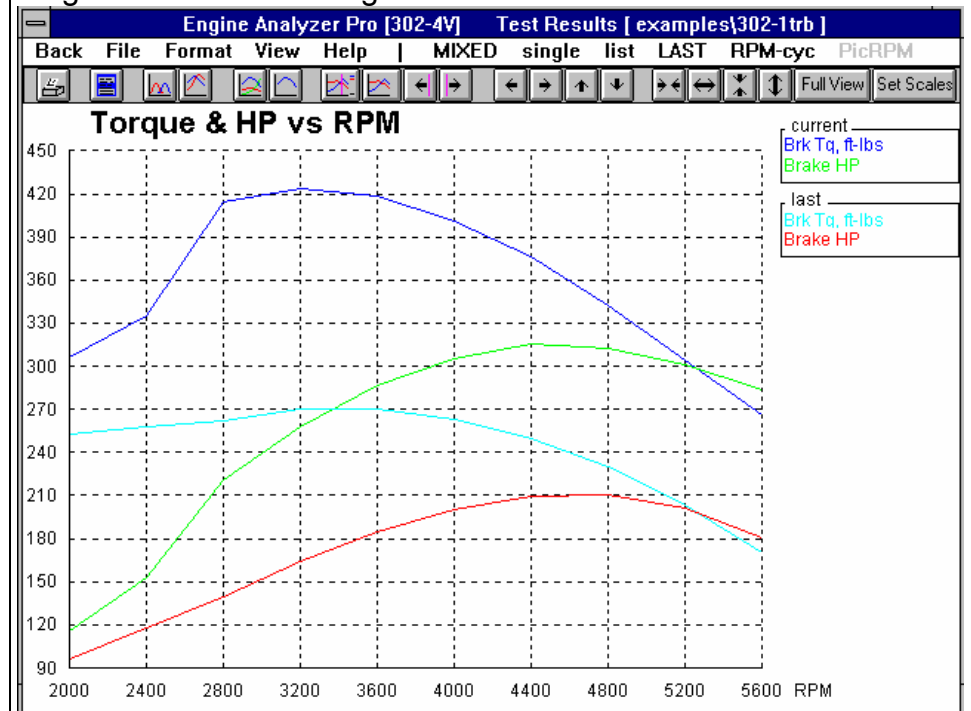

- 8.8 PSI and stays there. This is due to the wastegate limiting boost to 8.8 PSI.
- Exh Pres is much higher than stock. This increased Exh Pres is where the turbo gets its power to compress the fresh air charge.
- Actual CFM air flow has increased from 343 to 489 at 5600 RPM. The stock 600 CFM carb should still be adequate for flow.
- Recommend Primary Jet and Secondary Jet have decreased somewhat with the turbo. The higher air flow provides a stronger metering signal. The carb may have to be rejettted with smaller jets. (If this was a "blow through" system the recommended Primary Jet and Secondary Jet would be entirely different.)
- Fuel Flow has increased from 120 lbs/hr to 171 at 5600 RPM. Fuel lines and fuel pump capacity may not be large enough. If this was a fuel injected engine, the injectors may not be capable of handling the extra fuel flow.
- In Port Tmp or intake port temperatures have increased from 161 to 270 degrees at 5600 RPM. Any type of compressor in the intake system will raise the air temperature simply due to compression and inefficiency in the compression process. This temperature rise also contributes to the increased Knock Index.

A very simple way to increase the size of this turbo is to simply "install" 2 of them. Return to the Turbocharger Specs menu and select 2 for # Turbos/Stages. Now calculate performance for this "twin turbo" 302.

Calculate performance and overplot this data with the base engine and single turbo data, as shown in Figure 4.36. The plot shows a relatively small improvement in HP at all RPMs. The main reason for the small improvement in HP is that both the single and twin turbo systems were limited to 8.8 PSI of boost. The twin turbo system's only advantage is the boost is produced more efficiently:

- Compressor Eff is in the 70% range at most RPMs.
- In Port Tmp is much cooler, 53 degrees cooler at 5600.
- Exh Pres is over about 4 PSI less at 5600.

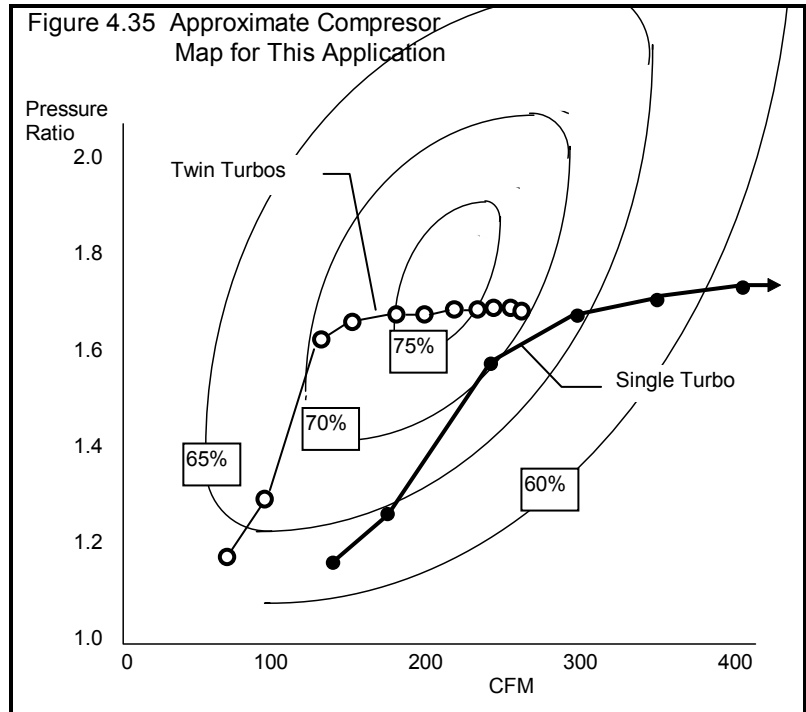

This efficiency improvement is also pointed out by plotting the Compressor PR and Actual CFM points for this system on Figure 4.35. These points are much closer to the center of the efficiency island. (Note that since there are 2 turbos, you must plot half of Actual CFM, since half goes through each turbo.

The performance of the base, single turbo and twin turbo engines are plotted in Figure 4.36. Although the twin turbo is more efficient and does produce more HP, it may not be worth the expense and complication over the single turbo. However, if you were to go to higher boost and/or make additional engine modifications, the twin turbo would likely show a bigger performance advantage.

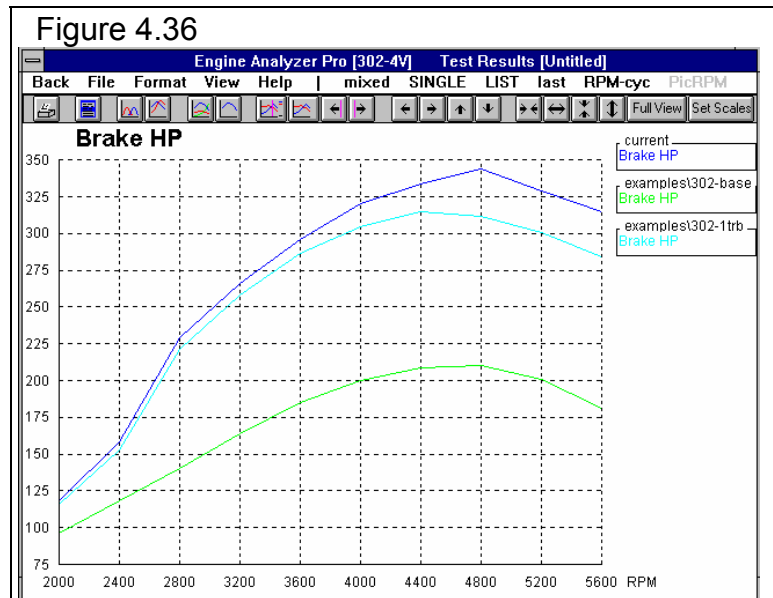

Note: The Engine Analyzer Pro does not simulate "turbo lag" or response time. A single turbo is faster responding than twin turbos of equal size, which may be an important advantage of the single turbo setup for street performance which the Pro can not show.

Safety Note: Remember, the turbo manufacturer has experience with factors not considered by the Engine Analyzer Pro. These factors include high exhaust temperatures affecting durability, over revving the turbo, turbo lag, etc. The Engine Analyzer Pro should only be used to estimate performance gains and understand the performance tradeoffs. Installing a turbo not properly matched to the engine can be dangerous to you and your engine.

Centrifugal Supercharger:

Return to the Main Menu, click on Turbo/Supercharger, select Centrifugal and click on View Specs. Retrieve the 1-PAXTON file of a belt driven, centrifugal supercharger from the Centrifugal Supercharger Library. From the comments, you see this typical single Paxton centrifugal supercharger for street applications. It has no intercooler but is set up to blow through the carb (carb after the compressor). The centrifugal Belt Ratio is currently set at 1.75, but can be easily changed. If you know the actual pulley diameters, you could click on the Clc button by Belt Ratio and calculate belt ratio from these diameters. For now, leave it at 1.75.

Calculate performance. Figure 4.37 shows 3 Single Data graphs of RPM Data. Compared to the single turbo performance:

- The centrifugal supercharger does not provide as much boost, torque or HP.
- The boost for this set-up does not really start until 2400 RPM. Increasing the belt ratio would definitely bring on the boost sooner and likely produce more boost and HP at higher RPMs. However, we could be in danger of over-revving the supercharger at higher RPM.
- With less boost at low RPM, the centrifugal supercharger shows a lower Knock Index (less likelihood to detonate) at lower RPMs.
- Exh Pres does not increase as significantly as with the turbo. However, Compressor HP gets as high as 34 HP at 5600.
- This is the HP the compressor requires from the crankshaft (through the S/C belt).
- The recommended Primary Jet and Secondary Jet have increased significantly. This is typical of "blow through" systems, which require larger jets.

Safety Note: Unlike real superchargers, you can over-rev the supercharger in the Engine Analyzer Pro with no problems. The Pro will warn you of the over-revving condition based on the Maximum Safe Impeller RPM spec and belt ratio, but it is up to you to pay attention to it. Always follow the manufacturer's recommendations for maximum belt ratios and RPM limits.

Figure 4.37 Single Data Graphs Comparing Baseline, Single Turbo and Paxton Performance

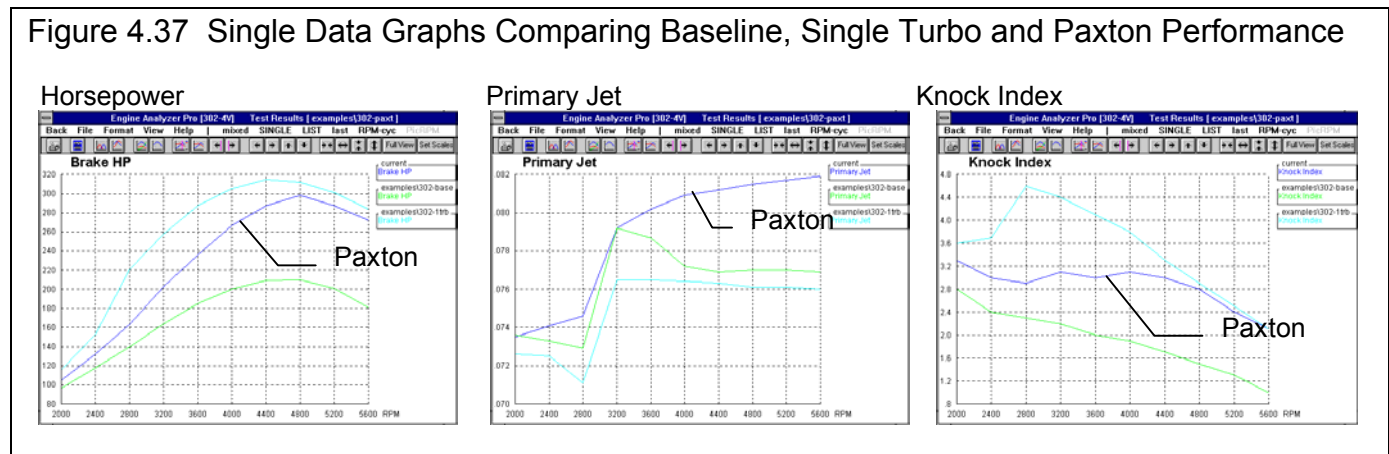

Since the centrifugal supercharger provides fairly good high RPM power, you are considering installing nitrous oxide injection as well. You have heard that nitrous delivers tremendous low speed torque, which would fill in torque at low RPM where the supercharger builds little boost. At the Calculation Conditions menu, click on the With Nitrous Oxide option which enables the See Nitrous Specs button. Click on this button to display the Nitrous Oxide Specs menu shown in Figure 4.38. We will simulate a "small" 100 HP, single stage nitrous system, activated at 2500 RPM by setting the Specs as shown in Figure 4.38.

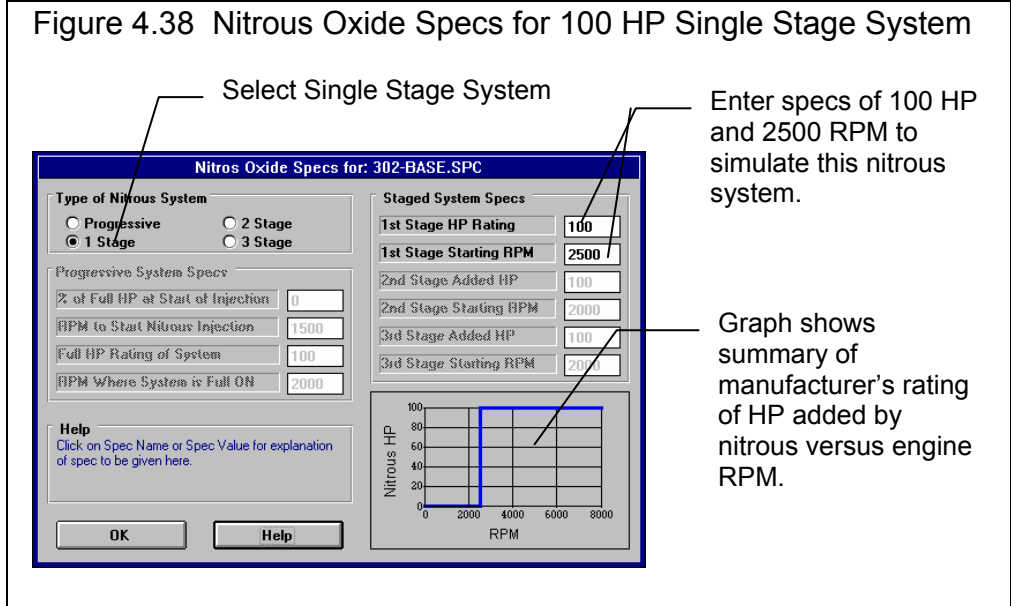

Recalculate performance and overplot torque and HP as shown in Figure 4.39. Even a relatively small nitrous system does provide HP improvements, even at low RPM (indicating tremendous torque improvement). Test Results show a 135 ft lb increase at 2800 RPM.. Other factors to consider from the calculated results include:

- Nitrous (nitrous oxide) flow jumps up to 322 lbs/hr and Ntrs Fuel (fuel flow for the nitrous) jumps to 45 at 2800 RPM and hold constant. You will notice that Fuel Flow(fuel flow from the injectors or in this case the carburetor) remains basically unchanged. The Pro assumes Ntrs Fuel comes from a separate source typical of most nitrous oxide injection systems.
- Max Cyl Pres (maximum cylinder pressure) has increased from 832 PSI to over 1100 PSI at 2800. Above 2800 Max Cyl Pres has also increased at least 100 PSI. Better head gaskets, head bolts, etc may be needed.
- Required Spark Advanc dropped from 22.5 degrees to 14.5 degrees at 2800. Nitrous burns faster, requiring less spark advance. Be sure to retard your spark when you run nitrous.
- Note that In Port Tmp drops from 186 to 122 degrees. The Pro assumes some of the nitrous does evaporate and cool the air charge in the intake manifold However, real nitrous systems usually cool more than what the Pro indicates.
- As pointed out with the turbo set-up, Actual CFM air flow and Fuel Flow have increased significantly over the base engine. The fuel system components may need to be enlarged and the carburetor re-jetted.

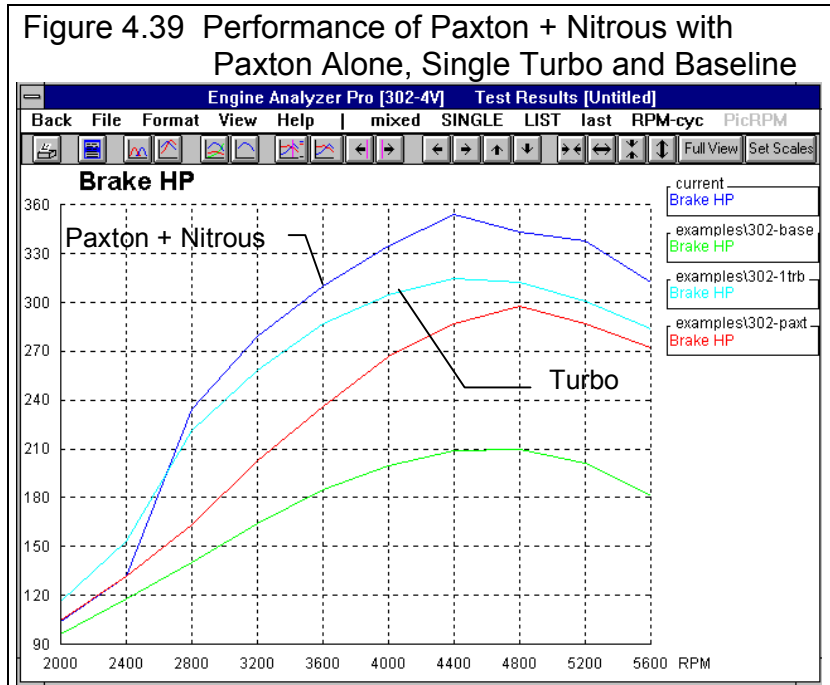

Figure 4.39 shows that the centrifugal supercharger with a small nitrous oxide kit produces significantly more HP than any other system tested at all RPMs above 2500 RPM, where nitrous injection is activated. You may decide this approach gives the best “bang for the buck” for improved performance.

Conclusions:

- Turbocharging, supercharging and injecting nitrous oxide can provide a significant performance increase on a basically stock engine.
- Turbocharging and supercharging make an engine prone to spark knock (the Knock Index increases significantly) where boost is high. Care must be taken to prevent detonation by retarding spark, running high octane fuel, etc.
- The Engine Analyzer Pro provides a method to estimate performance increases and points out potential problems before the modification is made (excessive spark knock, insufficient fuel pump capacity, rejetting the carburetor, etc.)
- As with any modifications, the Engine Analyzer Pro can not consider all details. Therefore, you must follow the manufacturer's recommendations for safe, reliable operation of a particular system.

The new Enterprise Edition has several features for working with turbo compressor maps in more detail, and for graphing the operating point on the compressor map during calculations. Check it out in Appendix 13, page 287.

For Advanced Users, Limiting Knock Index:

As shown by Knock Index, several of these modifications significantly increased the engine's tendency to spark knock or detonate. The simplest ways to avoid detonation is to either increase octane or retard spark advance. Since there is a limit to what octane fuel can be purchased on the street, most engines run spark curves with significant spark retard.

The Engine Analyzer Pro lets you run most any spark curve you want using the Spark Curve Specs available through the Calculation Conditions menu. For the calculations run in the previous section of this example Spark Curve Specs were set to **Program sets spark for best power**. This tells the computer to determine the engine's burn rate and then set a spark advance giving maximum power for this burn rate. Very few engines, especially race or boosted, can run optimum spark advance with street octane gas.

By selecting the **Use Specified Spark Curve** option, the See Specs button becomes enabled. Click on this button to open up the Spark Curve Specs Menu where you can customize the spark curve. You will notice for the Projected Performance of the stock 302-4V, the Knock Index was highest at lower RPMs. This is typical, as most engines are more prone to knock at low RPM. However, with boosted engines, the highest Knock Index appears with the highest boost level. Therefore, the spark curve you build in the Pro will should have less spark advance at low RPM and RPMs with high boost levels.

The only way to develop a spark curve which reduces Knock Index to a certain level is by "cut and try". Let's take the example of the single turbo. We'll leave Fuel Octane under Fuel Specs at 87 which can be found at any gas station. If you had wanted to design to high octane street gas, you could set Fuel Octane to 91-93 before building the spark curve. The method would be the same.

You must also decide what level of Knock Index you will accept. The stock 302-4V had a Knock Index of 2.8 to 1.0. The Pro states that detonation is very likely with a Knock Index over 2. Knowing this and the fact that you will usually run a fuel with better than 87 octane, you could design to run a Knock Index of 2.0 or less. We will try to obtain a spark curve which limits Knock Index to 2.0.

First some rules for designing spark curves:

- There is no advantage to over-advancing the spark from what the Pro sets when the option **Program sets spark for best power** has been selected.
- If you know a spark advance which produces a high Knock Index, you must retard it to reduce Knock Index.

Following these rules we look at Figure 4.40. Knock Index is 2.0 or less at 4000 RPM or higher with optimum spark advance. Therefore, no retard is needed from the current optimum spark at 4000 on up. The current spark ramps up from 21 degrees at 2000 to 26

Figure 4.40 Baseline 302-4V Knock Index x 10 and Spark Advance

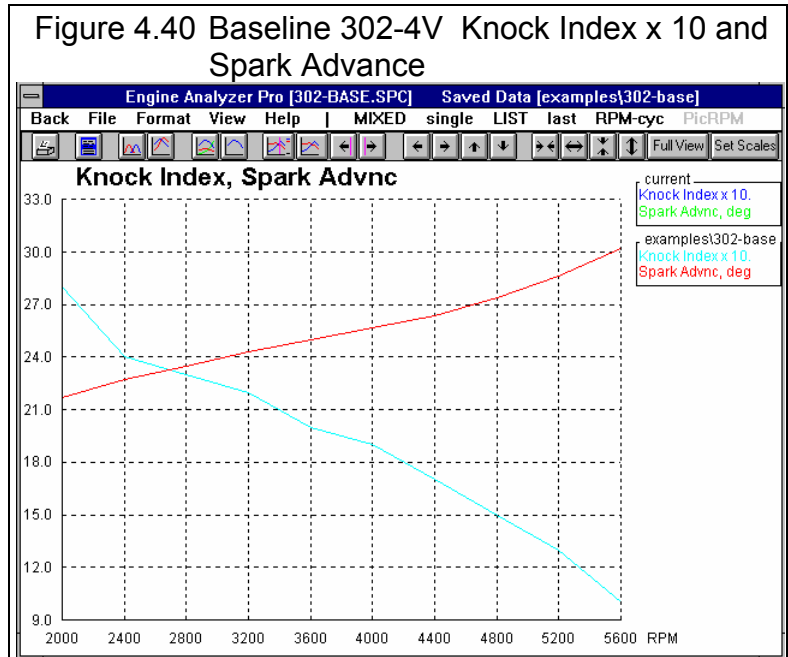
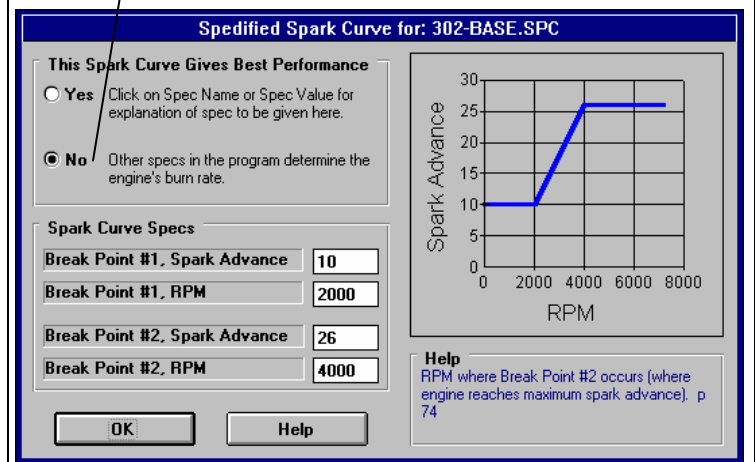

Figure 4.41 First Try at Custom Spark Curve to Limit Knock Index

Be sure to select this option so as not to change the engine's burn rate.



degrees at 4000 where Knock Index ramps down from 2.8 to 2.0. This is the section we will have to adjust.

The first brake point could be at 2000 RPM, with a spark advance retarded from the current 21 degrees, say 10 degrees. The second break point could be at 4000 RPM, using the current 26 degrees. Lets try these specs as shown in Figure 4.41 and see what happens.

The settings shown in Figure 4.41 mean the computer will determine the engine's burn rate just as before, but the spark advance

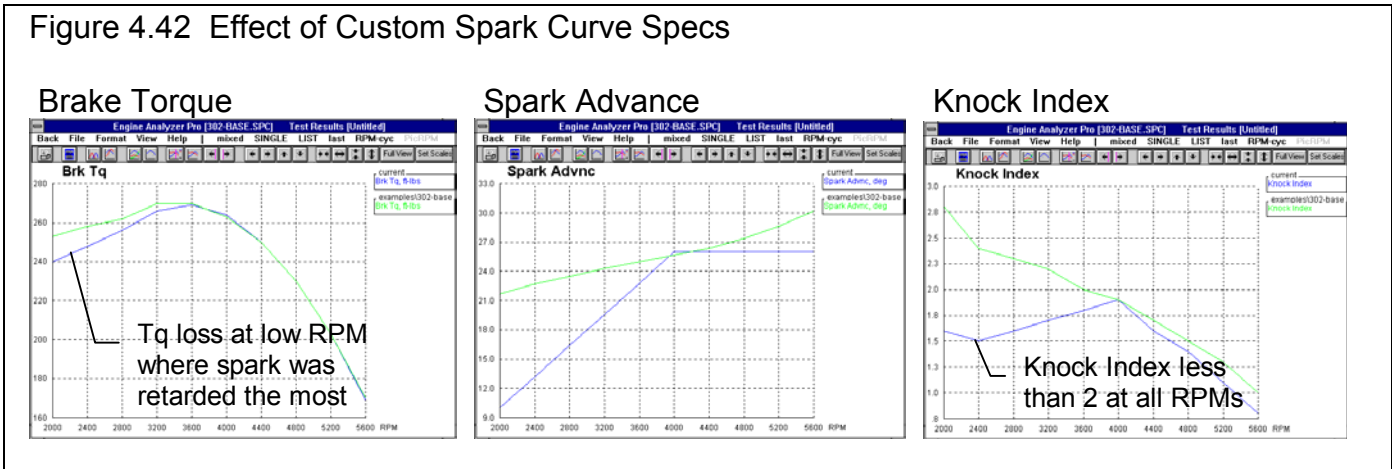

will be set from these Spark Curve specs. Spark will start at 10 degrees until 2000 RPM. Then it will "ramp" up to 26 degrees at 4000 RPM where it will stay as RPM increases. Calculate performance for this specified spark curve and plot Brk Tq, Spark Advance and Knock Index over the baseline as shown if Figure 4.42.

Figure 4.42 shows Knock Index is less than 2.0 at all RPMs with the new custom spark curve settings. You will also notice a drop in performance from the retarded spark at low RPM, where spark was retarded the most from the original Optimum spark curve. However, at high RPM there is almost no loss in performance.

With further adjustment of the Spark Curve specs, you might obtain a curve with Knock Index of exactly 2.0 at all RPMs. However, your detailed effort may be wasted. Remember that the program does not exactly know your engine. One cylinder running a little hotter or a little leaner may start knocking 5 to 10 degrees before the others. You can only use the Pro to find trends or develop a starting point for a spark curve. The Pro's projected performance will always be slightly different from the actual engine.

Conclusions for Advanced Users:

- The Pro has detailed features for investigating an engine's tendency to detonate or spark knock.
- The Pro gives the user great freedom to build custom spark curves.

Example 4.4 Using Flow Bench Data

Features Introduced (and suggested background reading):

- Cylinder Head(s) Specs and Flow Table (Section 2.3)

New Head Specs and Flow Table inputs and features have been added or expanded in later versions. See Appendices 9 - 13 on pages 235-312 for more updated info.

The Engine Analyzer Pro allows you to enter flow bench data for your cylinder heads and intake manifold separately. From this information you can determine the flow restriction of the head; flow restriction and tuning capabilities of the manifold runner or header and any "anti-reversion" characteristics.

The Pro lets you characterize the port and valve flow capacity (Flow Coef) two ways:

- Use Single Flow Coef
- Use Flow Table

Use Single Flow Coef enables the Single Flow Coef spec which describes the flow capability at one valve lift point, namely at $L/D = .25$. Use Flow Table lets you enter flow data into a table at several valve lift points.

For the first part of this example, we will just use one Flow Coef value at L/D of $.25$. The section "For Advanced Users" describes the use of a full Flow Table.

The basic procedure for obtaining flow data for the Pro is to:

- Flow the head with an optimum entrance or exit adapter to get data to calculate Flow Coef at $L/D = .25$.
- To determine Runner Flow Coef, flow again with the actual manifold or header replacing the entrance/exit adapter.
- To determine anti-reversion, flow the head and manifold or header in the reverse direction.

For this example, let's assume our circle track class rules have been changed. Next year we must run stock, unported cast iron heads (1.94 intake valve, 170 cc ports) and intake manifold (runners 2" high by 1.1" wide). We will flow test these parts and use the Pro to estimate the HP loss with the new head and intake manifold. The flow numbers used in the example are arbitrary. Your flow tests will likely show similar but not equivalent trends.

Flow Test:

This flow test will be performed at 28" water test pressure, but it could be any test pressure over 7" water. To calculate the port/valve Flow Coef, the Engine Analyzer Pro needs flow data at an L/D of $.25$, which is $.485$ " valve lift for the 1.94" valve. It is not necessary to flow the valve at exactly $.485$ " lift. Any lift from $.470$ " to $.500$ " would be close enough to $L/D = .25$. However, do *record* the exact lift where the port was flowed which the program will use to calculate Flow Coef.

To obtain the optimum air flow for the head only, it is necessary to install a radiused inlet adapter on the intake port. Set up the test condition of 28" test pressure and $.485$ " lift with the adapter. The flow reads 201 CFM. Leave all flow bench settings "as is" and remove the adapter. You may note that the flow drops, for example to 191 CFM without the adapter when you adjust the test pressure back to 28". (It may be necessary to shut down the flow bench between readings to avoid overheating.)

Now install the intake manifold without the carb or throttle body. Be sure all openings in the manifold other than carb/throttle body opening are sealed. This includes all runners not being tested, vacuum ports, injector bosses, EGR openings, etc. Adjust

the test pressure back to 28" and you obtain a reading of 194 CFM. Note that the head and intake flow better than just the head without the adapter but not as good as with the entrance adapter.

To obtain flow data to calculate anti-reversion, reduce the valve lift to approximately .100" lift with the intake manifold installed and record air flow in the normal, intake direction. You obtain 54 CFM Then turn off the bench and reverse the flow direction by switching to exhaust flow direction. Start the bench and you will note the flow falls to 48 CFM when you adjust the test pressure back to 28".

Table 4.5 Flow Test Results, 1.94" Intake Valve

Condition	Test Pres	Valve Lift	L/D	CFM
Head, no adapter *	28"	.485"	.25	191
Head, optimum adapter	28"	.485"	.25	201
Head and intake	28"	.485"	.25	194
Head and Intake, for anti-reversion		.100"	.05	54
Head and intake, reverse direction for anti-reversion	28"	.100"	.05	48

* This data is not used, just given for information.

Now, start up the Engine Analyzer Pro program. Retrieve a new copy of the RSTR-SBCHEV file by clicking on the retrieve button at the Main Menu Calculate performance to obtain baseline performance with the production head and intake. Save these test results as a Test File (if you have not saved them before).

Return to the cylinder Head(s) menu and enter the new Intake Valve Diameter of 1.94. Leave Int Port Length at 4.5 inches, since both heads' intake ports are equally long. Then click on Clc for Intake Avg Port Diameter to get this Calculation Menu as shown in Figure 4.43. Follow the descriptions in Figure 4.43 to calculate 1.71 for the new Avg Port Diameter for the new head.

Then click on the Intake option of Use Single Flow Coef. The Single Flow Coef spec and Clc button become enabled and the Flow Table button becomes disabled. Click on the Clc button to calculate Single Flow Coef to obtain the first menu shown in Figure 4.44. The flow data of 201 CFM at 28" test pressure at .485" valve lift produces a Calc Valve Flow Coef of .444. Click on Use Calc Value to copy this back to the Head specs menu. Next click on the Anti-Reversion Clc button to produce the second menu of Figure 4.44. Fill in the flow data of 54 CFM in the normal direction and 48 in the reverse direction. This produces a Calc Anti-Reversion of 11%. Again click on the Use Calc Value to copy 11 back to the Head specs menu.

Figure 4.43 Calculating Avg Port Diameter for Intake Port

Click here to open up this Calculation Menu

Calculated port diameter appears here

Choose Yes here first

Fill in port measurements.

Click here to load calculated diameter back into Avg Port Diameter in Head(s) menu

Click here to calculate Single Flow Coef

Click here to calculate Anti-Reversion

After calculating Avg Port Diameter, click here to tell program you only have flow data at 1 valve lift.

Figure 4.44 Single Flow Coef and Anti-Reversion Calculation Menus

The Intake port specs in the cylinder Head(s) menu now represent the new head. To simplify this example, we are neglecting combustion chamber design, exhaust port, compression ratio, and other specs about the new head.

Next go to the Intake System menu and click on Clc for Runner Dia @ Head. You will get the menu of Figure 4.43. Since you do not have runner volumes for the manifold, choose No for Know Runner Volume. Then enter width and height

dimensions from measurements made at the mating face to the cylinder head. Enter the manifold's runner width of 1.1, height of 2 and choose Rectangular for Shape. These inputs result in a Calc Avg Diameter of 1.67. Click on Use Calc Value to return to the Intake System menu with 1.67 entered for Runner Dia @ Head.

Next, click on Clc Runner Flow Coef to obtain the Calc Runner Flow Coef menu shown in Figure 4.45. Figure 4.45 shows the test data from Table 4.5 filled in and a calculated Runner Flow Coef of 2.213. Click on Use Calc Value to return to the Intake System menu with 2.213 entered for Runner Flow Coef.

This new manifold is a dual plane design, like the stock manifold so Manifold Type will stay Dual Plane-carbs. The corner runners measure approximately 6" long, while the inside runners measure 4". That would average out to 5" for the Runner Length for the new intake. Rules also state that the crossover must be open and no heat shield can be used under the intake.

Therefore, set pick Prod (full) Heat for Intake Heat. The same carburetor will be used, so Total CFM Rating will stay at 255.

Calculate performance for the RSTR-SBCHEV with the new head and intake manifold. Figure 4.46 is a comparison graph of the baseline with the new, more restrictive intake. As the graph shows, performance has dropped at all RPMs.

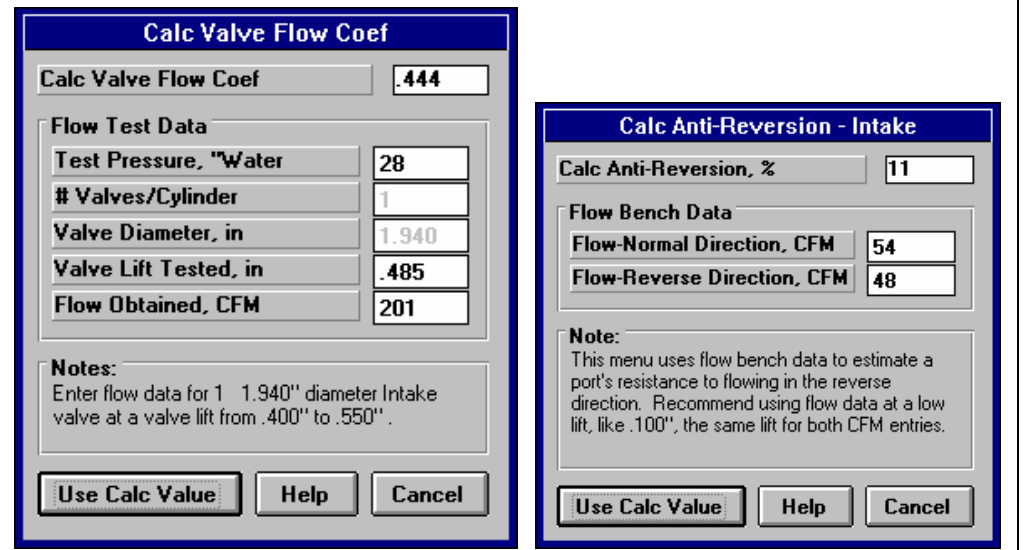
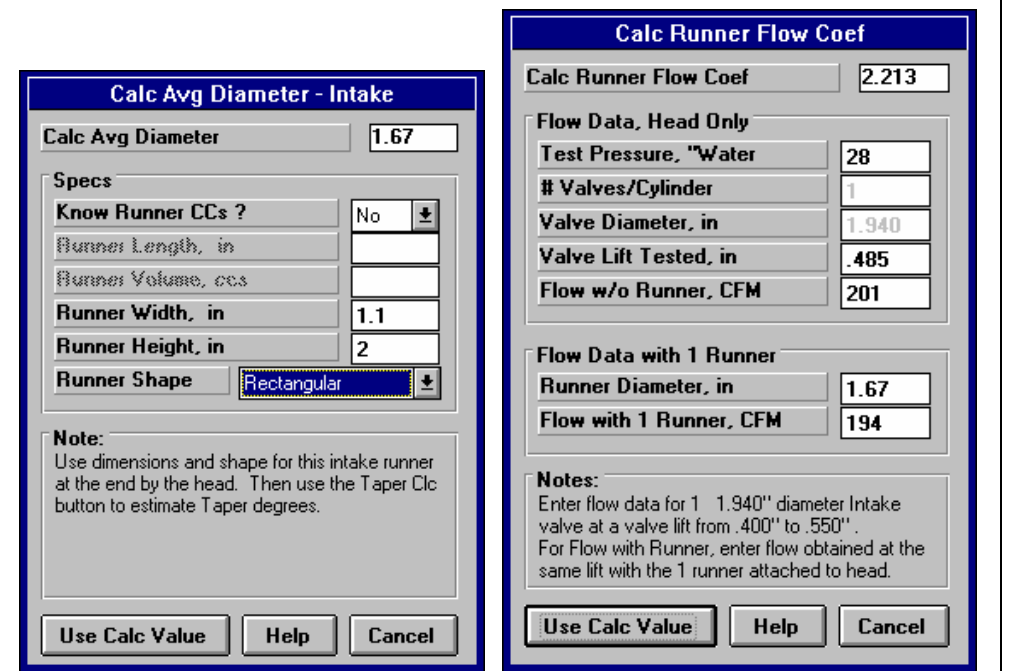

Figure 4.45 Runner Dia @ Head and Runner Flow Coef Calc Menus



The new heads and intake dropped peak HP from 307 to 276 and dropped average HP from 257 to 240. Remember we only changed the intake port. We would have to change the exhaust port and other exhaust specs for a true comparison.

Alternate Method:

If it is difficult to design optimum exhaust and intake adapters, or this data is not available, it is then best to flow the head with the appropriate manifold or header. For the example above, this would give 194 CFM. Most of the restriction is due to the valve and some is due to the manifold runner.

A reasonable assumption is 4% of the total flow restriction is due to the runner. If you multiply the CFM flow for both the port and manifold together by 1.04

you will obtain a reasonable flow value to use for the head itself. In this case $194 \text{ CFM} \times 1.04 = 202 \text{ CFM}$. Using 202 CFM you would calculate a valve Flow Coef of .447, and an input of 194 would calculate a Runner Flow Coef of 1.892. These numbers are similar to those actually measured in Table 4.5.

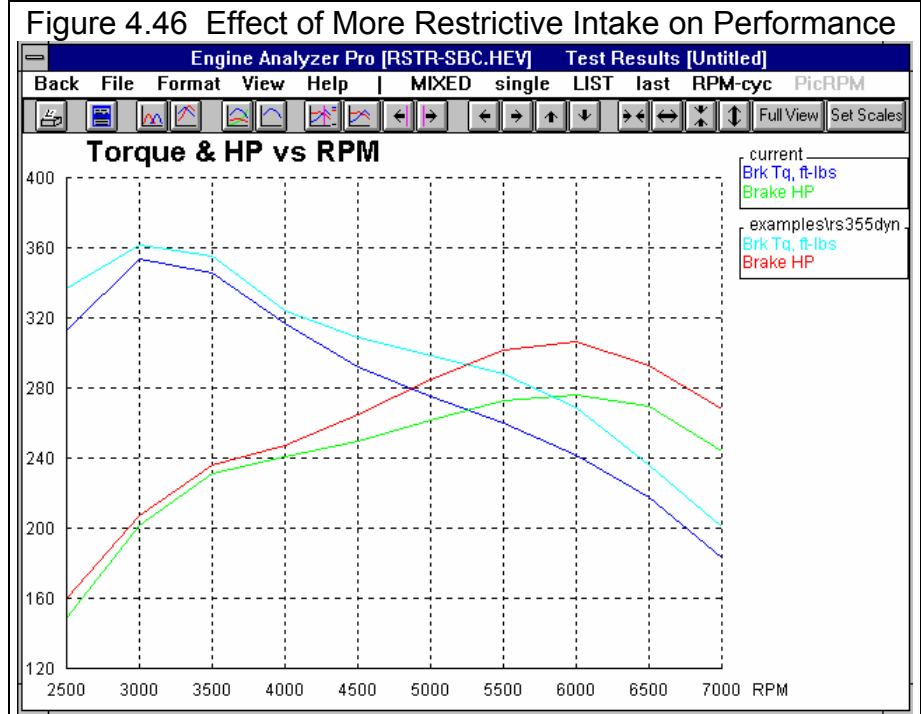

Conclusions:

- The Engine Analyzer Pros calculation menus allow you to easily calculate valve Flow Coef, anti reversion, and Runner Flow Coef from flow bench data.
- An alternative method is suggested if you only have data for flowing the head and manifold as a unit.

For Advanced Users:

Many times the difference between cylinder heads may not be significant at the L/D = .25 point. For example, one head may have much more low lift flow than another due to valve seat modifications. The only way to investigate these detailed modifications is by entering the full flow curve into the Pro's Flow Table.

To obtain your flow data for the Flow Table, follow the recommendations in the first section of this example. Use entrance and exit adapters when flowing the head itself. Obtain flow CFM at some constant test pressure (over 7" water) at several lift points.

For an ideal test obtain CFM for 6 somewhat evenly spaced lift points between 0 lift and L/D=.25, one CFM point at L/D = .25, and one CFM point at the maximum valve lift (before coil bind). At the L/D=.25 lift point, also record flow with the actual intake or exhaust manifold/header (to calculate Runner Flow Coef) and the reverse flow with the actual manifold/header (to calculate anti-reversion). You do not need these extra points at all lifts, just at L/D=.25. See Table 4.6.

Table 4.6 Full Flow Test Results, 1.94" Intake Valve

Condition	Test Pres	Valve Lift	L/D	CFM
Head, optimum adapter	28"	.050"	.03	26
Head, optimum adapter (also used for Anti-Reversion calculation)	28"	.100"	.05	54
Head, optimum adapter	28"	.200"	.10	102
Head, optimum adapter	28"	.300"	.15	140
Head, optimum adapter	28"	.400"	.21	174
Head, optimum adapter	28"	.450"	.23	191
Head, optimum adapter	28"	.485"	.25	201
Head, optimum adapter	28"	.600"	.31	205
Head and intake manifold	28"	.485"	.25	194
Head and intake manifold, for Anti-Reversion, reverse direction	28"	.100"	.05	48

To load these flow test results into the Flow Table, first set the Intake Valve Diameter to 1.94 in the cylinder Head(s) menu. Then bring up the Flow Table by selecting the Use Flow Table option which enables the Flow Table button. Then click the Flow Table button to display the Flow Table as shown in Figure 4.47.

First, you must enter the test pressure or 28 " at which the head was flowed.

Then start entering valve lifts and CFM flows measured at 28". You may first want to use the Clear All Data button to clear out the flow table, or you can just type the new numbers over the existing flow data. As you enter valve lifts and CFMs, you will see the L/D automatically calculated and displayed, plus the Flow Coef at that particular lift. When you enter .485" lift and 201 CFM, you will notice that the Flow Coef calculated is .444 This is the same as was calculated from the simpler menu in the first section of this example.

Figure 4.47 shows all the new flow data entered and the resulting Flow Coefs. Notice the trend of Flow Coef being relatively high at low lifts, then slowly dropping until L/D=.25, then increasing again at higher lifts. This is the normal trend and is easy to see in the graph. If you have Flow Coefs which do not follow this trend, it may be pointing out an error in the data. Also see Figure 2.8 on page 18. When you are finished entering data, simply click on OK to return to the Head(s) menu.

If we had not just performed the first part of this example, where we calculated Anti-Reversion, Intake Manifold Runner Flow Coef, and the port and runner diameters, we would have to do that before calculating performance. We would also have to change the other intake manifold specs as we did in the first part of this example. We will assume this has already been done, and that you saved the baseline performance and performance with the Single Flow Coef calculated from flow data as Test Files. Therefore, we do not have to repeat those tests.

Figure 4.48 shows the performance for the 3 conditions, 2 from the first part of this example, and the last one from using the Flow Table to characterize the flow of the intake port. As you can see, performance is down when using the full Flow Table. The reason is that the actual port did not flow as well at valve lifts other than L/D = .25 as what the Pro

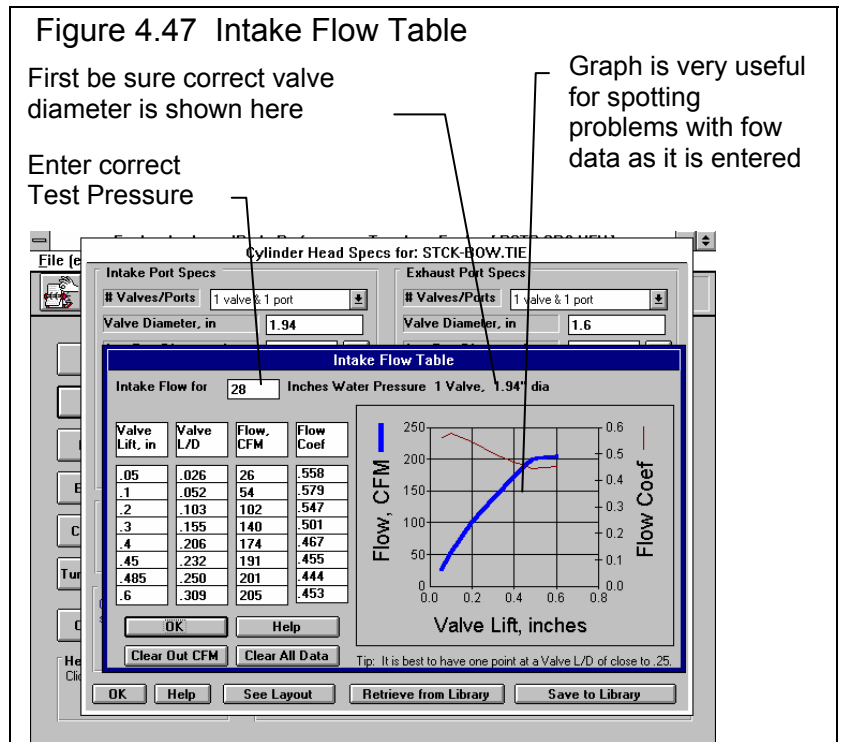

assumed it would. This is pointed out in the Valve Flow Area graph shown in Figure 4.48. See Figure 2.37 on page 88 for a definition of Valve Flow Area. Valve Flow Area is significantly less when using the Flow Table, which results in less air flow capacity and therefore less HP.

The Pro also calculates the exact Valve Flow Area and displays this in the Special Calculations section (lower half) of the test results as shown in Table 4.6.

Table 4.6 Comparison of Single Flow Coef and Flow Table Performance

Condition	Peak HP	Avg HP	Valve Flow Area, sq in x deg
Original Baseline with 2.02 intake valve	307	257	278.0
1.94" intake valve using Single Flow Coef	276	240	244.5
1.94" intake valve using complete Flow Table	268	236	229.9

Table 4.6 shows the same trend as Figure 4.48, that the computer assumes the Valve Flow Area is greater than it actually is if you just use Flow Coef=.444. The major difference is in the "mid lift" points. At the cam's peak lift at around 450 degrees, the

Figure 4.48 Performance and Valve Flow Area for Baseline, Single Flow Coef and Flow Table

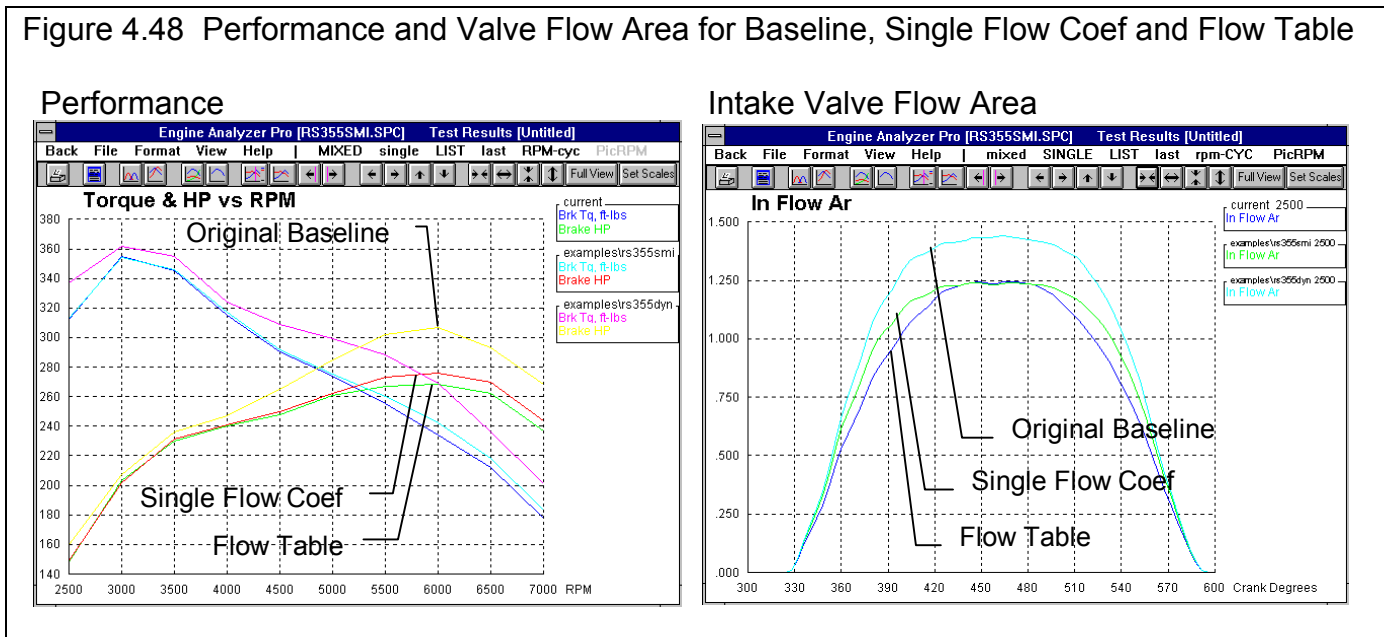

Valve Flow Areas are the same. However, the original head with the 2.02" valve flows significantly more at all but the very low lifts. This points out the need to have a full flow curve for the head, both intake and exhaust, for the best performance predictions.

Figures 4.48 and Table 4.6 also show that the higher the Valve Flow Area, the higher the HP output.

Conclusions for Advance Users:

- For the maximum accuracy, it is best to have a complete flow curve for the intake and exhaust ports.
- The Engine Analyzer Pros Flow Table menu allows you to easily enter the flow curve data, recorded at most any test pressure.
- The Flow Table's Flow Coef calculations let you spot errors in the flow data you enter.

Example 4.5 Optimizing Tuning

Features Introduced (and suggested background reading):

- Appendix 1 Accuracy and Assumptions
- Appendix 3 Intake and Exhaust Tuning
- Appendix 5 Watching Tuning Pressure and Flow

New inputs and features for graphing have been added or expanded in later versions. See Appendices 9 - 13 on pages 235-312 for more updated info.

The Engine Analyzer Pro simulates the pressure pulsations which are present in the intake and exhaust runners. These pulsations are critical to obtain optimum performance, especially for naturally aspirated, free flowing race engines. With intake and exhaust systems designed to take advantage of these pulses, volumetric efficiencies of well over 100% are possible without supercharging.

Since tuning effects are most noticeable with free flowing heads and high overlap cams, we will use the SUPERSTOCK Buick V-6 engine for this example. In this example, we will show how to use cycle plots to understand the tuning pulses in the intake and exhaust system and how they affect performance. To simplify things and save calculation time, we will look primarily at 7500 RPM, an RPM close to the HP peak.

Retrieve a copy of SUPERSTOCK from the library. Calculate performance with the ‘Starting Point’ Recommendations RPM under Calculation Conditions set to 7500. Important points from these Test Results include:

- Mach# at 7500 RPM is a relatively low .415 indicating the intake valve should not be too restrictive at this RPM.
- The TOTAL EXH/INT % of 81.9 is somewhat higher than the recommended 75%. Therefore, the exhaust valve and cam profile should not be too restrictive. The recommended intake runner size for 7500 RPM is 10.4 inches long by 2.16 inches in diameter, which is slightly shorter and wider than the current intake runner size. See Figure 4.49.

Note: The dimensions recommended in Figure 4.49 are based on very general “rules of thumb”. The Engine Analyzer Pro’s calculations are not based on these same rules. Therefore, the Pro may not give best performance with these runner dimensions. However, they are useful as a starting point.

Table 4.7 shows a comparison between these recommendations and the engine's current specs. It is not surprising that most of the recommendations are very close to the Buick's current specs. This engine has been fairly well optimized for performing between 6000-8500 RPM. Let's look first at changing the intake runner dimensions, then the exhaust to see the effect on runner pressures and velocities. Each test will be saved as a test file to allow for easy comparison graphs.

Table 4.7 Current Buick V-6 Specs versus Recommended Dimensions for Good Tuning at 7500 RPM

Dimensions *	Current (actual)	Recommended
Intake Port Length + Runner Length	10	10.4
Avg of Int Port Dia and Runner Dia	approx 1.96	2.16
Exh Port Length + Header Primary Length	34.5	38
Avg of Exh Port Dia and Header Primary Diameter	approx 2.0	1.97

* Recommended dimensions are from the valve to either the plenum or collector. Therefore, you must add the port length in the head to the runner length. You must also account for the port diameter being different than the runner length.

Figure 4.49 Special Calculations Section Showing Runner and Cam Recommendations

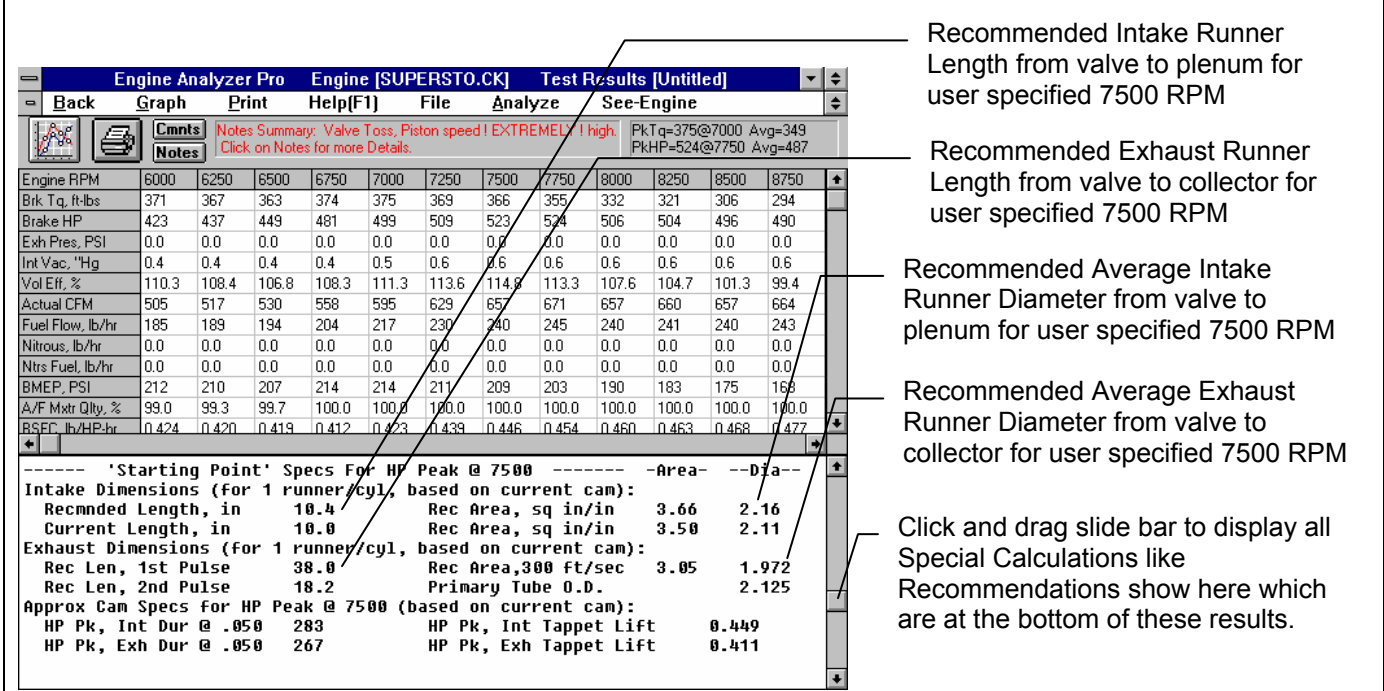

Intake Tuning:

First, let's look at changing the intake runner's length and compare the In Port Vel and InPort Prs for 3 cases, original length, shorter and longer. First, subtract 3" from the original Runner Length of 5" under Intake System. Calculate performance with this 2" runner. Notice that Brk Tq, Brake HP and Vol Eff% have dropped at almost all RPMs. Save these results as a test file for comparison plots.

Return to the Intake System menu and now add 3" to the original Runner Length of 5" for a length of 8". Calculate performance again and save these results as a test file for comparison plots. Figure 4.50 shows intake tuning pressures and velocities for these 3 conditions. It points out general trends which apply for most all engines concerning intake tuning:

- The longer the runner, the deeper the suction pulse at the start of the piston's downward stroke after TDC. This deep suction pulse can hurt performance if extremely deep and extremely long.
- The longer the runner, the higher the reflected pulse is at intake closing after BDC. This high reflected pulse is the most important for producing strong intake tuning to help performance.
- The longer the runner, the later the reflected pulse arrives back at the port. If the runner is too long for a particular RPM, the reflected pulse will arrive very late and the intake valve may have already closed. Then the engine can not take advantage of it. All the long runner is doing then is providing a deep, long suction pulse which hurts performance considerably.

Now, repeat this process changing the intake runner diameter instead of the length. First, set Runner Length back to its original 5" in the Intake System menu. This time calculate performance with a .2" smaller diameter and .2" larger diameter intake runner over the runner's entire length. For these conditions, you must change both the Intake System menu's Runner Diameter and the Cylinder Head(s) menu's Intake Avg Port Diameter. Table 4.10 gives a summary of the runner modifications and results.

Figure 4.51 shows the plots of InPort Pres and InPort Vel for the different diameter intake runners.

Figure 4.50 Effect of Changing Intake Runner Length
Intake Port (tuning) Pressure

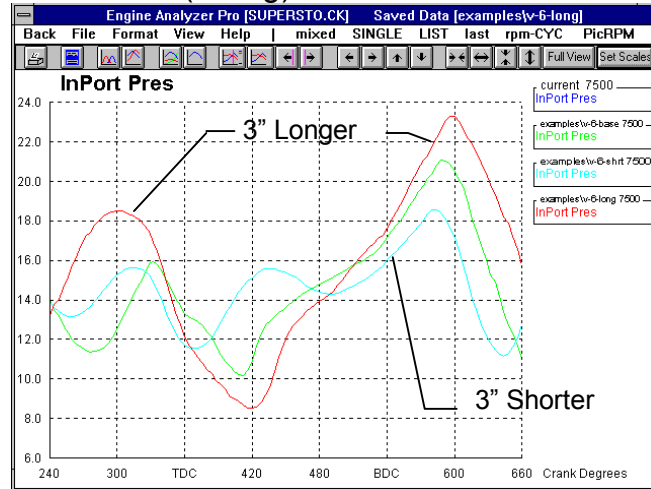

Intake Port (tuning) Velocity

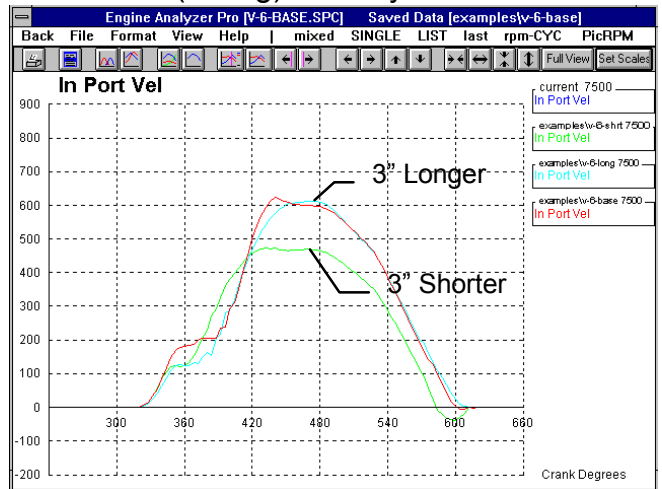
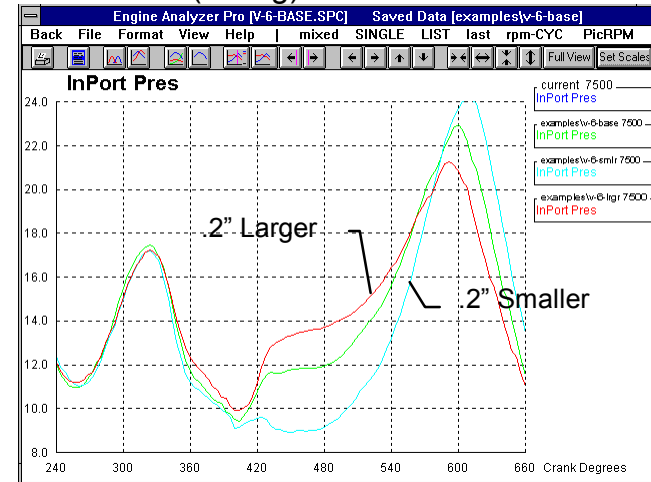

Figure 4.51 Effect of Changing Intake Runner Diameter
Intake Port (tuning) Pressure



Intake Port (tuning) Velocity

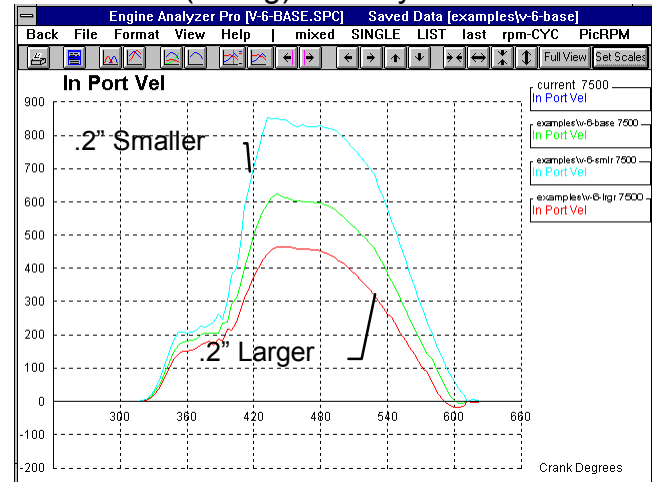

Figure 4.52 Effect on Performance from Changing Intake Runner Dimensions

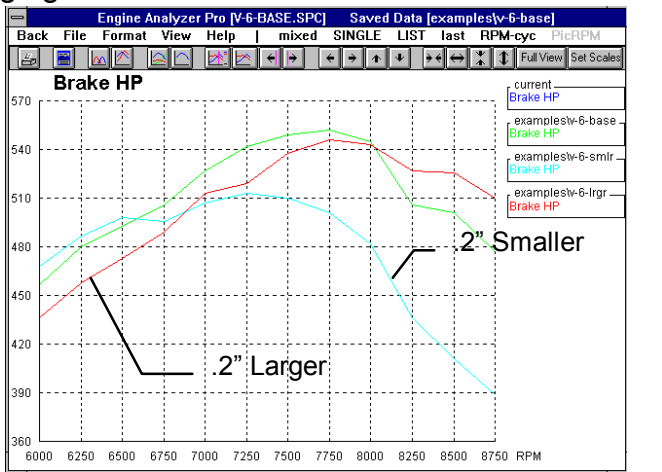
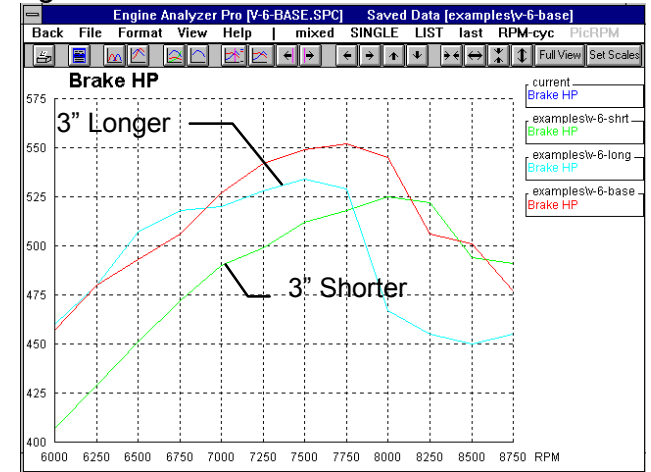

Table 4.10 Summary of Changing Intake Runner Dimensions

Condition	Baseline	3" Shorter	3" Longer	.2" Smaller	.2" Larger
Int Runner Length	5	2	8	5	5
Int Port Dia	1.82	1.82	1.82	1.62	2.02
Int Runner Dia	1.95	1.95	1.95	1.75	2.15
Results @ 7500					
Brk Tq	384	358	374	357	376
Brake HP	549	512	534	510	538
Vol Eff%	113.8	103.6	108.8	106.2	112.0
Pumpng Work	-24.4	-15.4	-24.3	-24.3	-22.7
In Tune Prs	5.6	3.0	6.2	5.5	4.6
Peak InPort Pres	23.0	20.1	23.8	24.1	21.2
Peak InPort Pres Location, deg after BDC	60	48	64	68	52
Peak InPort Vel	624	472	612	852	465

Table 4.10 shows us:

- In every case, changing the runner length or diameter caused a loss in performance at 7500. This makes sense as this engine has been optimized for approximately 7500 RPM.
- The highest Brk Tq and Brake HP occurs with the highest Vol Eff, which does not always have the highest In Tune Prs (listed in the RPM data) or Peak In Port Pres (which is Cycle Data). This shows that *where* the peak pressure occurs and the shape of the pressure wave is very important also.
- A high InPort Vel by itself is not a good indicator of the best performing runner dimensions for tuning.

Figures 4.50 and 4.51 show us:

- Peak In Port Pres generally increases as In Port Vel increases or runner length increases.
- The timing of peak In Port Pres (reflected pulse) occurs later as In Port Vel increases or runner length increases.
- Even with optimum tuning, some reverse flow can occur near intake closing.
- In general, for optimum tuning you want In Port Pres as high as possible in the area around intake valve closing. However, if the peak occurs too close to intake closing, the valve is too far closed to take advantage of it. The Figures do not show this, but if the peak occurs too far before intake closing, some air will be pushed out before the intake valve closes. This would be indicated by higher amounts of negative InPort Vel near intake closing.

Figures 4.52 shows the effect of these different runner dimensions on the whole HP curve. It points out some general trends for changing intake runner dimensions:

- Making intake runners longer and/or smaller diameter moves the tuning peak and HP peak to a lower RPM.
- Making intake runners shorter and/or larger diameter moves the tuning peak and HP peak to a higher RPM.

Exhaust Tuning:

The Engine Analyzer Pro also lets you investigate the effect of exhaust runner (header primary) and collector dimensions on tuning and performance. As we did in the Intake Tuning section of this example, we will change exhaust runner (header primary) dimensions and watch the effect on port pressures and HP.

Figure 4.53 shows that as the runner length gets longer, the width of the initial "blowdown" pulse also gets wider. This blowdown pulse is the loud crack you hear in the exhaust of race engines with early exhaust opening. After the blowdown pulse, a vacuum pulse will appear, vacuum being a pressure less than atmospheric pressure. Atmospheric pressure is approximately 15 PSIA. This vacuum pulse is caused by the reflection of the blowdown pulse from the end of the header pipe

Figure 4.53 Effect of Exhaust Header Dimensions on Exhaust Port (tuning) Pressure

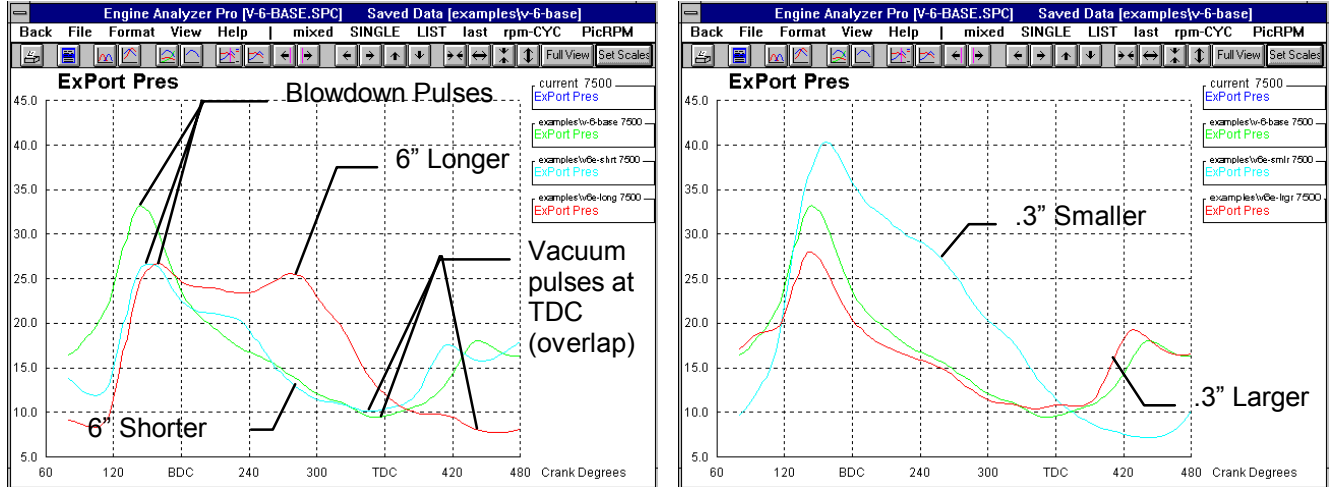
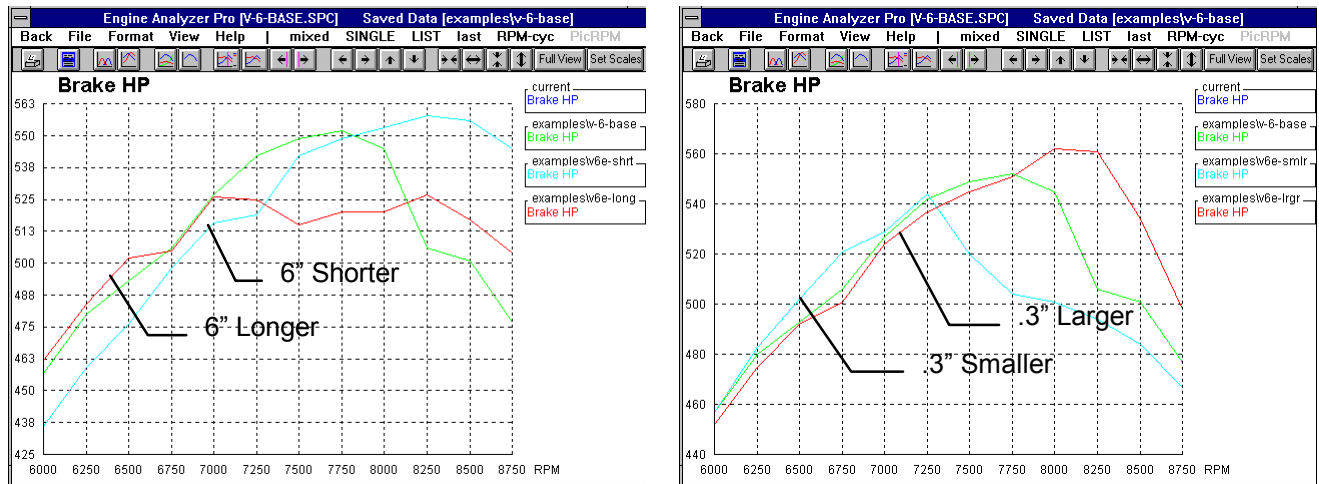

Figure 4.54 Effect of Exhaust Header Dimensions on HP



at the collector. In a highly tuned engines like this SUPERSTOCK V-6, a strong vacuum pulse during overlap, when both valves are open, produces the following desired effects:

- Clears out the cylinder of any residual exhaust to reduce “contamination” of the fresh incoming intake charge.
- Prevents reversion by keeping the exhaust flowing *out* of the cylinder and the intake charge flowing *into* the cylinder.
- Lets the intake charge get a “head start” at filling the cylinder, because the exhaust is sucking the intake charge into the cylinder before piston motion has started to suck the intake charge into the cylinder.

The larger the valve overlap, the wider the vacuum pulse should be for good exhaust tuning. This engine has a great deal of overlap, 74 degrees at .050” lift. Therefore we want a deep, wide vacuum pulse in the area around TDC. Figure 4.53 shows that both the longer and smaller diameter header pipe produce a very wide “blowdown” pulse, increasing the average exhaust pressure in the overlap area around TDC. Figure 4.54 shows that both the longer and smaller header primary produce much less HP at 7500 RPM as a result.

The shorter and larger exhaust headers don’t show much difference in vacuum pulse at TDC at 7500 RPM. Figure 4.54 shows that they both produce slightly less HP at 7500 RPM, but at RPMs over 7500 they both produce more HP. If this engine’s reciprocating parts and valve train can handle the higher RPM safely, it may be worth trying larger or shorter headers on this engine. However, remember you will have to rev the engine higher to take advantage of the higher HP. At RPMs below 7500, the larger and shorter exhaust primaries reduce power.

Figure 4.54 shows the same trends as were shown for intake runners:

- Making exhaust runners longer and/or smaller diameter moves the tuning peak and HP peak to a lower RPM.
- Making exhaust runners shorter and/or larger diameter moves the tuning peak and HP peak to a higher RPM.

Notes on Intake and Exhaust Tuning:

Although the Engine Analyzer Pro simulates intake and exhaust tuning pulses in great detail, there are still effects which are not yet completely understood or are simply not being simulated. These limitations include:

- Temperature effects, which affect the speed at which the pulses are reflected. Temperatures are affected by fuel type and specific fuel delivery system, manifold, combustion chamber, port and header design, header insulation, etc not simulated by the Pro.
- Specific runner design, like placement of bends, area changes, design of junctions, etc.
- Effects from other cylinders, for example standard V-8 vs 180 degree vs tri-Y header collector designs. (Some of the effects from other cylinders *are* simulated in relatively simple way.)
- Effect of runner restriction. Although the intake and exhaust Runner Flow Coefs can be measured on a flow bench, we do not completely understand how they define the runner's ability to tune. We do know that freer flowing runners do provide for better tuning, but not the exact relationship.

Due to these limitations, the Pro (as with most any computer model) can *not* predict the single best runner design. However, it is still quite useful for predicting trends and giving approximate runner designs. For absolute peak performance, these designs would have to be refined with dyno or track testing.

Conclusions:

- The engine's HP is strongly dependent on the amount of air it can flow, which is strongly dependent on pressure waves in the intake and exhaust runners and ports.
- The Engine Analyzer Pro allows you to simulate intake and exhaust tuning in great detail.
- By plotting intake and exhaust port pressures and runner velocities, you can gain a better understanding of tuning principles.

For Advanced Users:

In this example, as with many engine investigations, we made several changes to a spec to see how the engine's performance curves reacted. The Pro has a built in routine called *Chain Calculations* which let you program in several (up to 36) changes and have the program do each one automatically, without you being at the computer. This can be a great convenience. In this example, we will chain 36 changes to the exhaust header primary length and diameter. On a fairly fast Pentium computer, 36 runs of 12 RPMs could take a half hour or more to run. While the program is running, you can be doing other work.

Figure 4.55

Click on the Calculate Performance button

Select Yes for Do Chain Calculations

Click on See Chain Calculation Specs to display menu shown in Figure 4.56

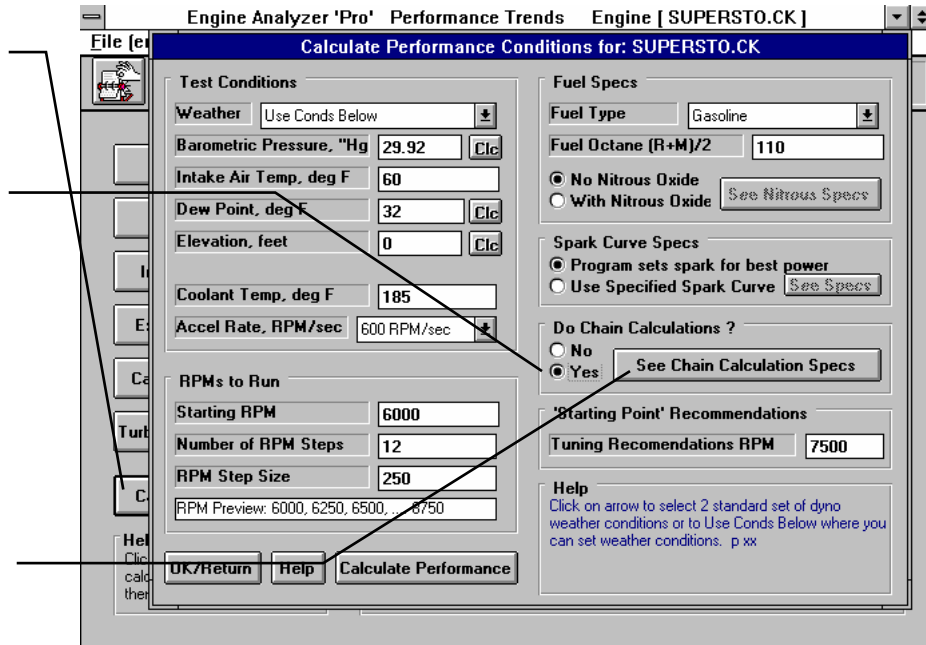

To run a Chain Calculation, first be sure all specs (except the ones you will change) match the specs of the engine you want to simulate. Then click on the Calculate Performance button at the Main Menu and select the Yes option for Chain Calculations as shown in Figure 4.55. Once Yes is selected, click on the Show Chain Specs button to display the Chain Calculation menu shown in Figure 4.56.

The settings in Figure 4.56 will make 30 runs with 5 settings of exhaust header diameter and 6 settings of exhaust header length. When finished setting the Chain specs, click on OK, then click on Calculate Performance in the Calculate Performance menu shown in Figure 4.55. These 30 runs, each consisting of 12 RPMs will take 30 minutes or more to complete. When they are finished, the results will be displayed as shown in Figure 4.57. Click on the Graph button and you can obtain either a torque or HP graph.

Figure 4.56 Chain Calculation Specs Menu

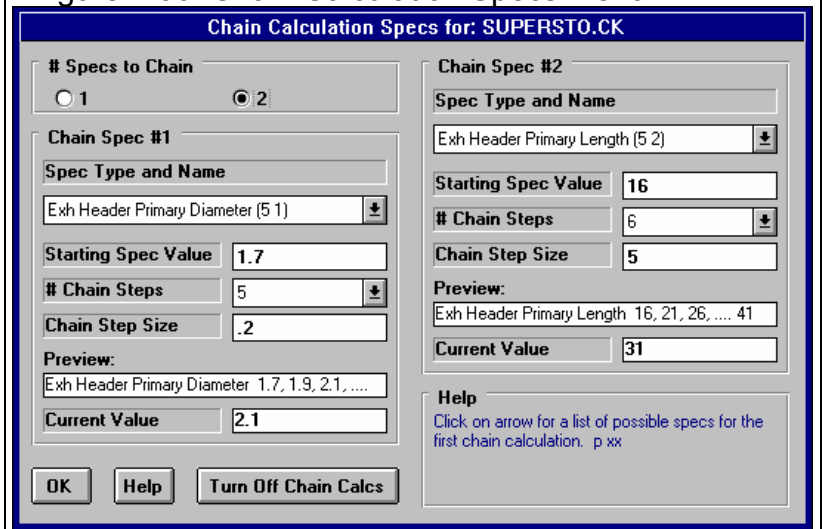

Because Chain Calculations generate so many runs and potentially several megabytes of data, only torque and HP data is saved or displayed. Therefore Chain Calculations are most useful to do quick trials of specs and see the effect on performance. For detailed investigations, where you may want to check detonation, check valve toss, do Cycle Data graphs, you must use single calculations as shown in the first part of this example.

The graph of Figure 4.58 can appear very confusing, especially as printed here in black and white. However, you can click on any run name in the graph legend and the corresponding graph will flash. This way you can see how each combination compares to all the others. If we do this, the combinations which appear the best in the RPM range around 7500 are:

- 1.9" x 26"
- 2.1" x 26" (this combination is one of the best up to over 8000 RPM)
- 2.1" x 31" (the original or baseline header)
- 2.3" x 31"

As shown in the first part of this example, it looks promising to try a slightly larger diameter or slightly shorter header primary, especially if the engine can rev safely to over 7500 RPM.

Chain calculations can also be saved for later reference, by clicking on File as shown in Figure 4.57. Then click on Save Current Test Results to Disk. Chain results can be saved to any directory, but have a .CHN file extension instead of a DAT extension of single run test files.

Conclusions:

- The Chain Calculation feature lets you run several tests automatically to find combinations which look promising.
- Chain Calculations only allow for torque or HP output. Therefore, for detailed investigations of other operating conditions like detonation, valve toss, cylinder pressure, etc, you must use single run tests.

Figure 4.57 Chain Results

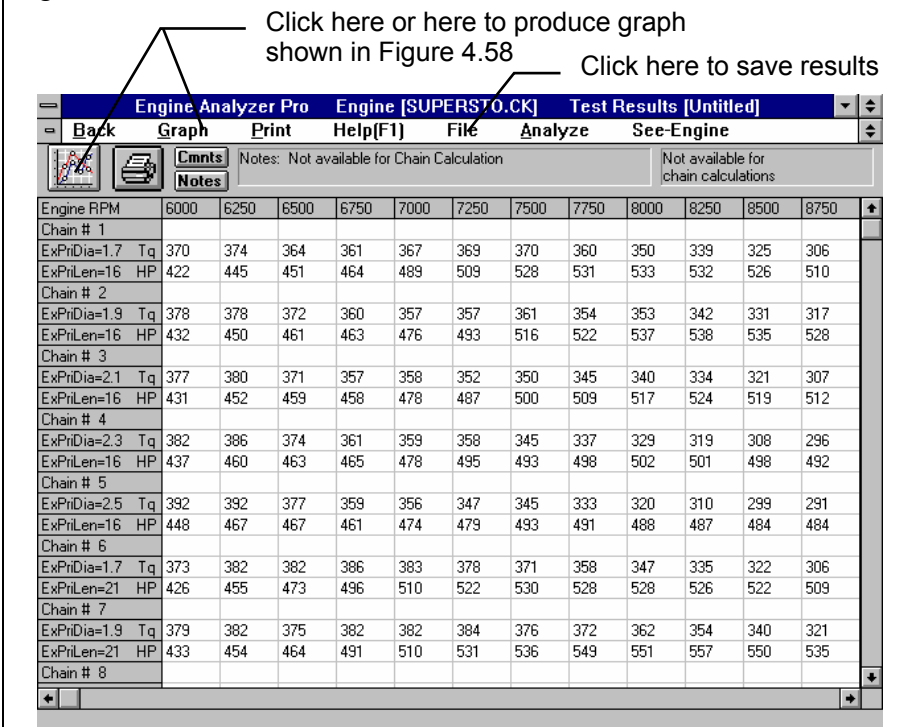
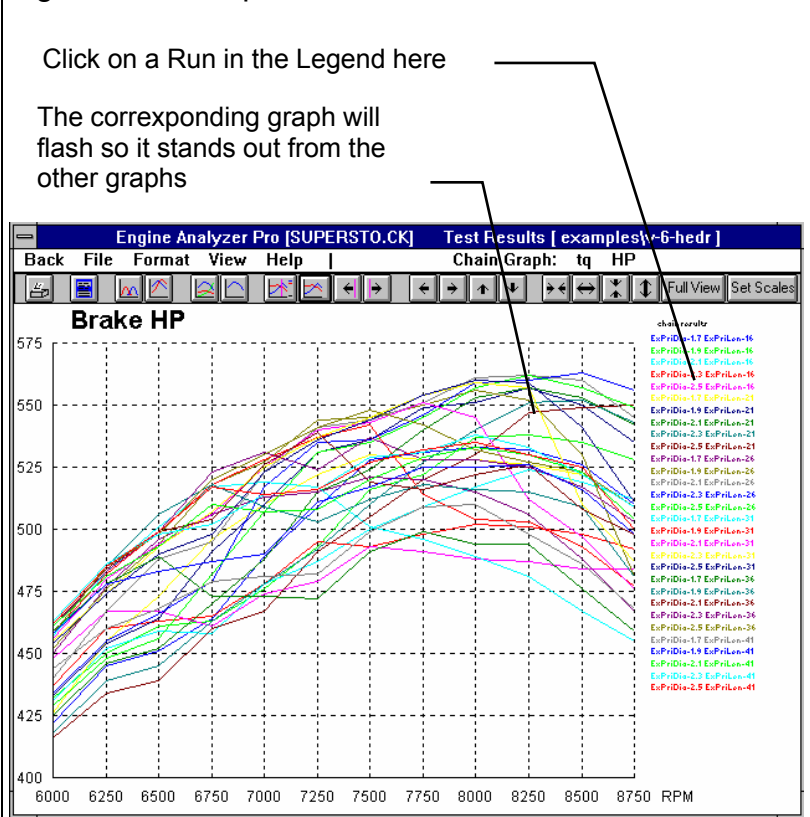

Figure 4.57 Graph of Chain Results



Appendix 1: Accuracy and Assumptions

Background:

The Engine Analyzer Pro was developed as a:

- Learning aid for those who want to better understand internal combustion engines.
- Tool to help predict effects of certain engine modifications for engine builders, engineers, racers, and performance enthusiasts.
- "Theoretical Dynamometer" to allow anyone to try things which are too expensive, difficult, or impossible with a real engine.

The Engine Analyzer Pro will provide you an engineering estimate of what should occur when general modifications are made based on internal combustion engine theory and general physics and thermodynamics. By seeing all the specifications which go into the calculated results, you may have a false sense that the computer knows your engine exactly, what manufacturer's intake manifold and carburetor are installed, who ported the heads, the exact cam profile. Actually the computer does not know if the specifications are for a flat head Ford or a Honda Formula 1 engine.

A good analogy to the Engine Analyzer Pro is a flow bench. A flow bench can not predict exact torque and HP curves, but is still a vital tool for engine development. In the same way, use the Engine Analyzer Pro results as a guide, as a second opinion of how your engine should perform under near optimum conditions.

Many users of engine simulation programs do not understand their true value. If you simply want to know how much HP a particular combination of specs will produce, our Engine Analyzer EZ can do a good job with only 20 inputs. However, if you want to know, "What will happen if I make the intake runner 1" longer?", the EZ version can not do it. The EZ version does not have an input for runner length so you can not add 1" to the runner length. ***The true value of engine simulations is the ability to accurately check for trends like "If I lengthen the intake runner 1 inch, this will happen." The ability to accurately predict trends from modifications has been greatly improved in the new Windows Pro v2.1.***

Iterations:

Before we talk about accuracy, it is important for you to understand the types of calculations going on inside the Engine Analyzer Pro and other sophisticated simulation programs. A simple engine program could involve calculating torque from volumetric efficiency:

$$\text{Torque} = K \times \text{engine displacement} \times \text{volumetric efficiency}$$

Where: K is a constant which includes many assumptions

You enter a volumetric efficiency and obtain a torque value. The answer you obtain on the left side of the equation has no effect on the inputs on the right side of the equations. (Some rather expensive programs are based on an equation no more detailed or complex than this. See "Other Engine Simulation Programs" in this Appendix.)

However, lets look at a simplified version of the Pro's equation which calculates the temperature rise of intake air as it passes through the intake port.

$$\text{Final Temp} = \text{Intake Temp} + K \times (\text{Final Temp} + \text{Intake Temp})$$

In this case the "Final Temp" answer you get on the left side has an effect on the inputs to the equation on the right. The only way to solve equations like this is through "iterations". Iteration is a process where you assume an answer, use that answer in the right side of the equation, calculate the actual answer and see if the actual answer is "close enough" to the answer you assumed. For example:

Iteration Process:

For this example, use above equation with $K=.3$, Intake Temp = 80

- A Assume Final Temp is 145 degrees
- B Calculate Final Temp: $80 + .3 \times (145 + 80) = 147.5$
- C Are assumed Final Temp and Calculated Final Temp Close Enough (within 1 degree) ?
- No, so do again using new Final Temp answer
- A' Assume Final Temp is 147.5 degrees
- B' Calculate Final Temp: $80 + .3 \times (147.5 + 80) = 148.25$
- C' Are assumed Final Temp and Calculated Final Temp Close Enough (within 1 degree) ?

Yes, so an approximate answer is:

$$\text{Final Temp} = 148.25 \text{ degrees}$$

If "close enough" was 3 degrees, our first answer of 147.5 degrees would have been good enough. If "close enough" was .1 degree, it may require many more calculations to arrive at an answer which is "close enough". If the equation is very complex and the inputs are an unusual combination, no answer may be reached no matter how many times the calculation is performed. This is called "not converging on a solution".

Making the tolerance "close enough" small will produce more exact answers but will require more calculation time. Performance Trends has selected tolerance bands for the Pro's many iterations which give good accuracy with reasonable calculation times.

Because many of the equations within the Engine Analyzer Pro must be solved by iterations, there is no one exact answer. All calculations are an approximation. For example, do not be alarmed if an Intake Valve Flow Area is calculated as 200.4 for "straight up" cam timing and as 200.8 with 4 degrees of cam advance. These numbers are close enough that they should be considered equal. Advancing the cam should not and did not change Intake Valve Flow Area.

Correlation with Dynamometer Data:

First we must say that *no engine simulation, even those used by the Big 3 automakers, replace dyno testing*. Although the Pro's results can match your dyno almost exactly for some engines, for others with different combustion chamber design, A/F distribution, carb fuel metering, etc, the trends and power levels could be off.

The Engine Analyzer Pro was validated using dynamometer data from many different engines, from small 5 HP Briggs & Strattons to 500 CID Pro Stocks. In general, the Engine Analyzer Pro's torque and HP results compared within +7% of the actual dynamometer data at most RPMs. For example, if the Engine Analyzer Pro predicted 400 ft lbs of peak torque, the actual engine would have from 372 to 428 ft lbs from dynamometer tests. The agreement is best near the torque and HP peaks.

We do not quote an improvement in accuracy over our simpler, standard Engine Analyzer program. Then you may wonder why go through all the extra work gathering specs and extra expense for the Pro.

- First, the standard Engine Analyzer is designed to work with fairly standard parts, typical cam profiles, turbos, superchargers, etc. In many cases, the standard version makes many assumptions for you so you may not know what types of parts it is using.
- Second, the Pro's more detailed analysis makes it more reliable at accurately predicting *trends* from modifications. At approximately every 0.2 degrees of crank rotation, it calculates intake and exhaust valve flow area, port pressure, flow through each valve, etc. Therefore, if you make a change to cam timing, valve flow, etc., the Pro' can more reliably predict the effect on performance. The accuracy of predicting *trends* has been significantly improved in Version 2.1 for Windows.
- Third, the Pro has many more inputs so you can simulate much more detailed engine modifications. For example, you can:
 - Investigate the effect of different cam profiles on performance, valve toss or pushrod loads.
 - Determine how modifications affect intake port pressure, cylinder pressure, spark knock or required jet size.
 - Check the effect of various cylinder head flow curves on performance, reversion or tuning.
 - Etc.

One must also remember that dynamometer testing is not an "exact science". How many times have you seen magazine stories of an engine dyno tested to produce 400 HP. But when the engine is installed in a car, it only runs 100 MPH in the quarter mile. Similar cars with 400 HP are running 110 MPH, so the dyno numbers are obviously too high. Significant variability exists from run to run, day to day and especially from dyno facility to dyno facility. Therefore, the dyno data you are comparing to the Engine Analyzer Pro results may be in error more than the program. See Appendix 4.

Figures A.1 - A.3 give some comparisons between Engine Analyzer Pro simulations and actual dynamometer runs testing various modifications. Figure A.4 show pushrod forces simulated by the Pro versus loads measured with instrumented pushrods. Figure A.5 shows simulated intake runner pressure pulses versus those actually measured in the intake runner. These examples will give you some feel for the accuracy to be expected from the program.

The examples shown here compare predicted results from the older DOS Pro. The Windows Pro v2.1 has equal or improved accuracy in most all situations and would show equal or better correlation as the graphs shown here.

Figure A.1: Predicted Effect of Cam Change From Pro Versus Measured On Dynamometer

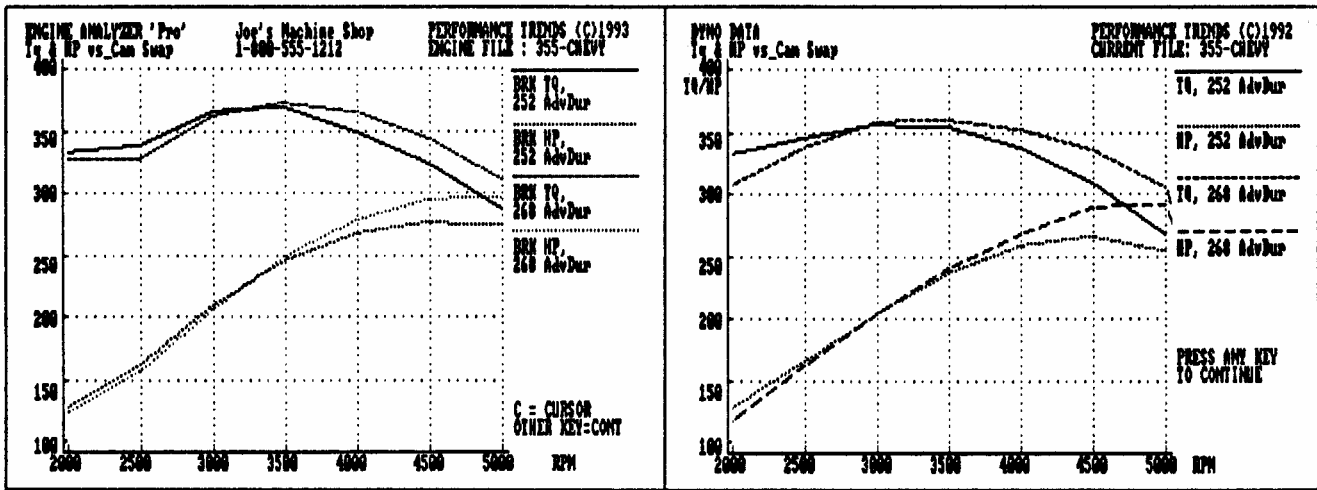

Figure A.2: Predicted Effect of Header Change From Pro Versus Measured On Dynamometer

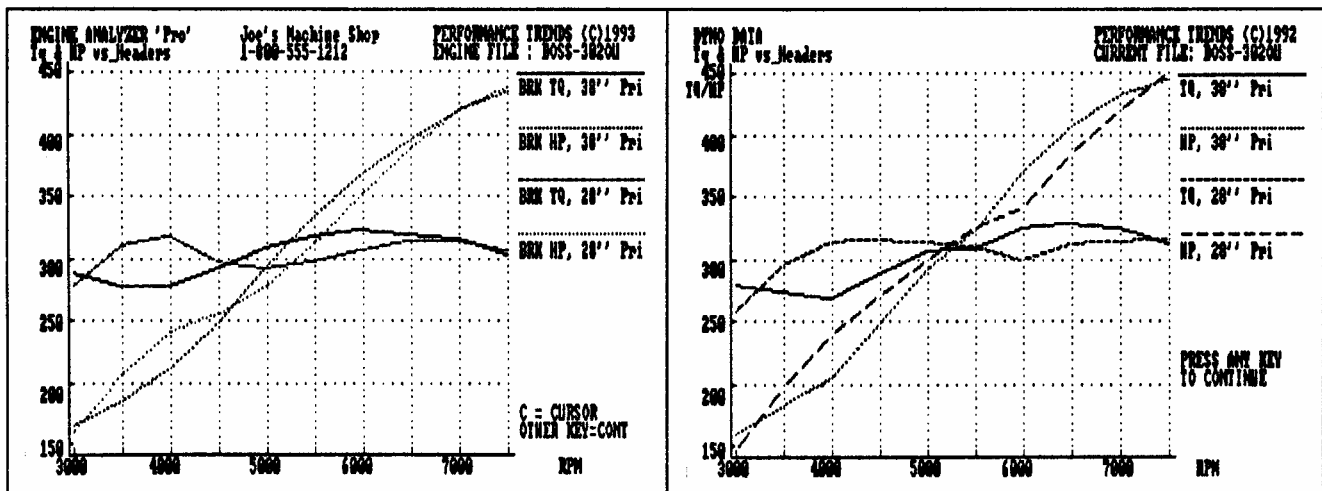

Figure A.3: Predicted Effect of Carb Change From Pro Versus Measured On Dynamometer

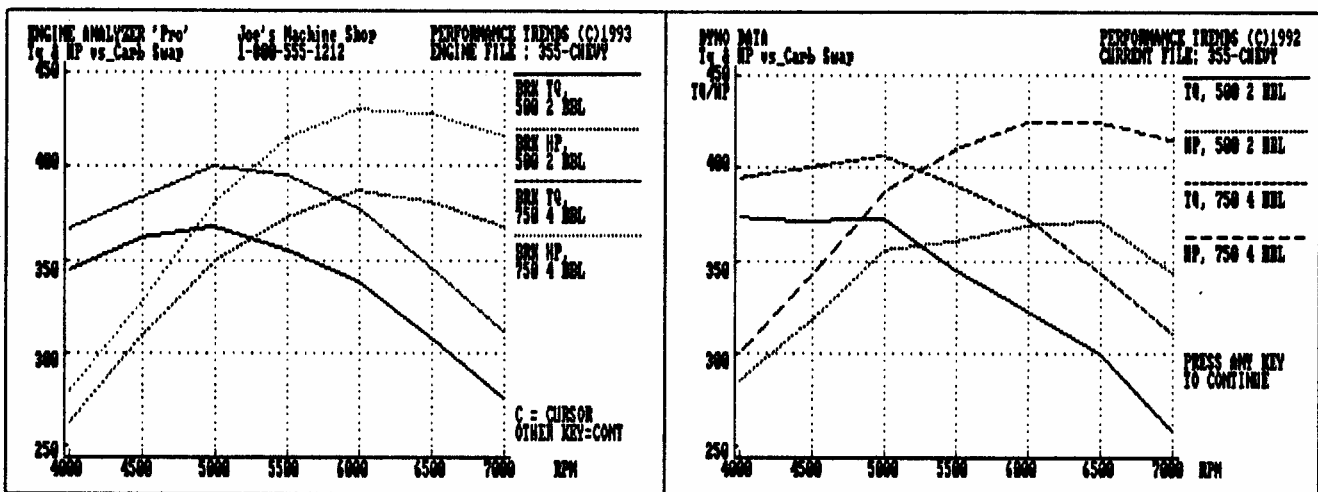

Figure A.4: Predicted Intake Port Pressure From Pro Versus Measured In Intake Runner

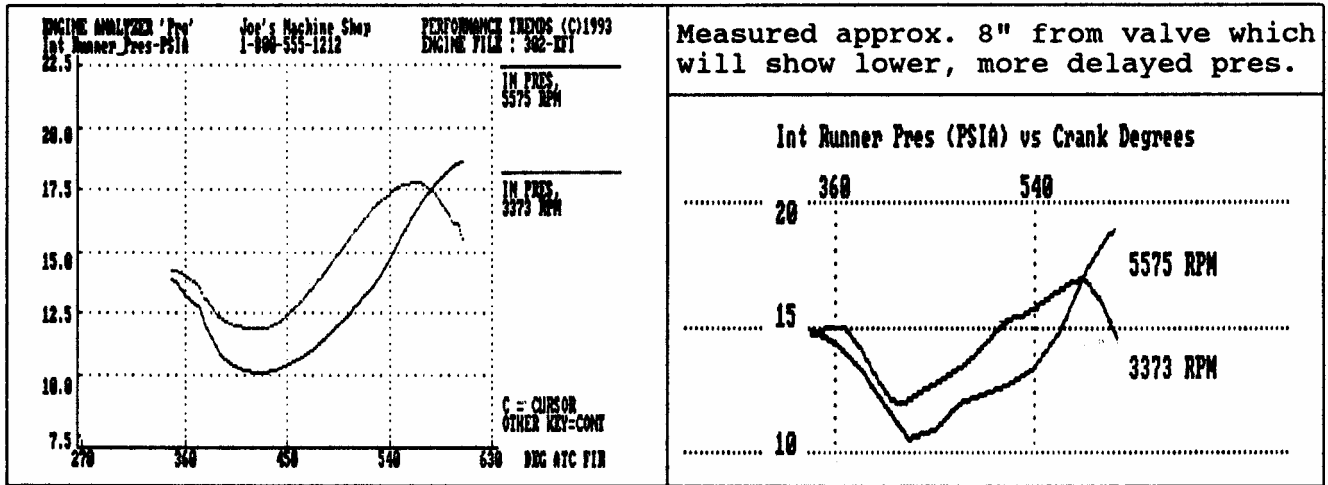
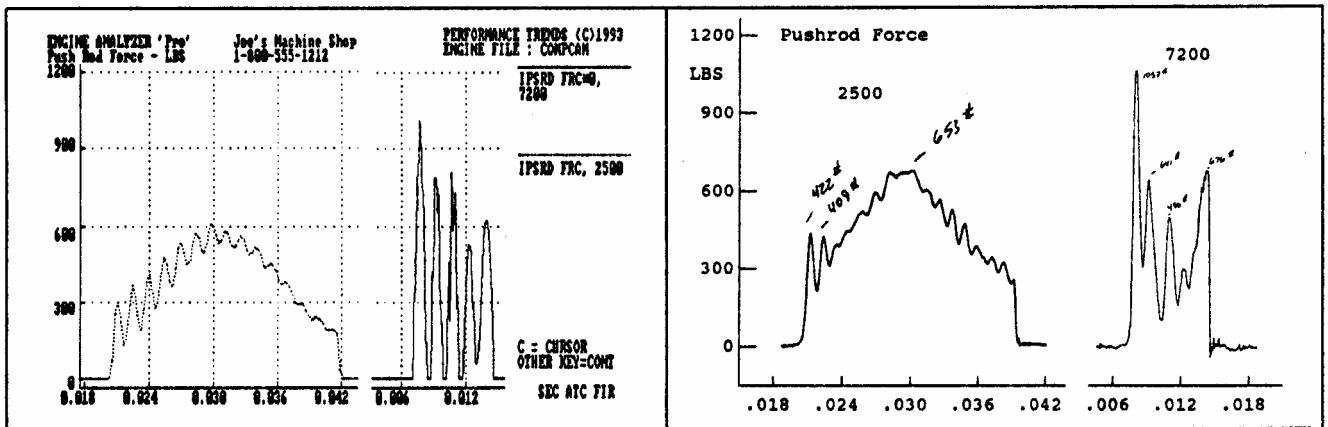

Figure A.5: Predicted Pushrod Force From Pro Versus Measured with Strain Gauged Pushrod



Major Assumptions:

To make the Engine Analyzer Pro, and the specifications which describe the engine, containable on a personal computer, several simplifying assumptions are made which are listed below. Other approximations and assumptions exist as identified in Section 1.3 A Word of Caution and scattered throughout this manual. See Assumptions in the Index.

- All cylinders and runners in the engine are identical.
- Spark occurs at exactly the same time for every combustion cycle. There are no misfires or "slow burns".
- For Gasoline simulations, the energy released during combustion is based on a fuel called octane, with a heating value of approximately 19,000 BTU/lb. For Drag Racing Gasoline, the heating value is slightly higher. For Alcohol, the heating value is 8,600 BTU/LB.
- For Gasoline and Drag Race Gas simulations, the program assumes that the fuel's vapor pressure (tendency to vaporize and atomize well) drops with increased Octane. Therefore, you may see A/F Mxtr Qlty drop as you specify higher fuel Octane.
- The frictional drag from Short Block specs like Cooling Fan Type, Water Pump & Drive, etc increase with increased engine displacement. For example, if you specify a stroke which is 20% longer to the Engine Analyzer Pro, displacement increases 20% and so does the friction from Cooling Fan Type.
- Intake and exhaust tuning are very complex simulations as identified in Appendix 3. Small changes in air temperature, surface temperature within the air tracts and effects from other cylinders make exact tuning simulations impossible. See Appendix 3 and Example 4.5 for more complete tuning assumptions.
- Figure A.6 is a simplified block diagram of the "engine" within the Engine Analyzer Pro.

Figure A6 Block Diagram of Computer Model

Figure A.6 Block Diagram of 'Pro' Computer Model

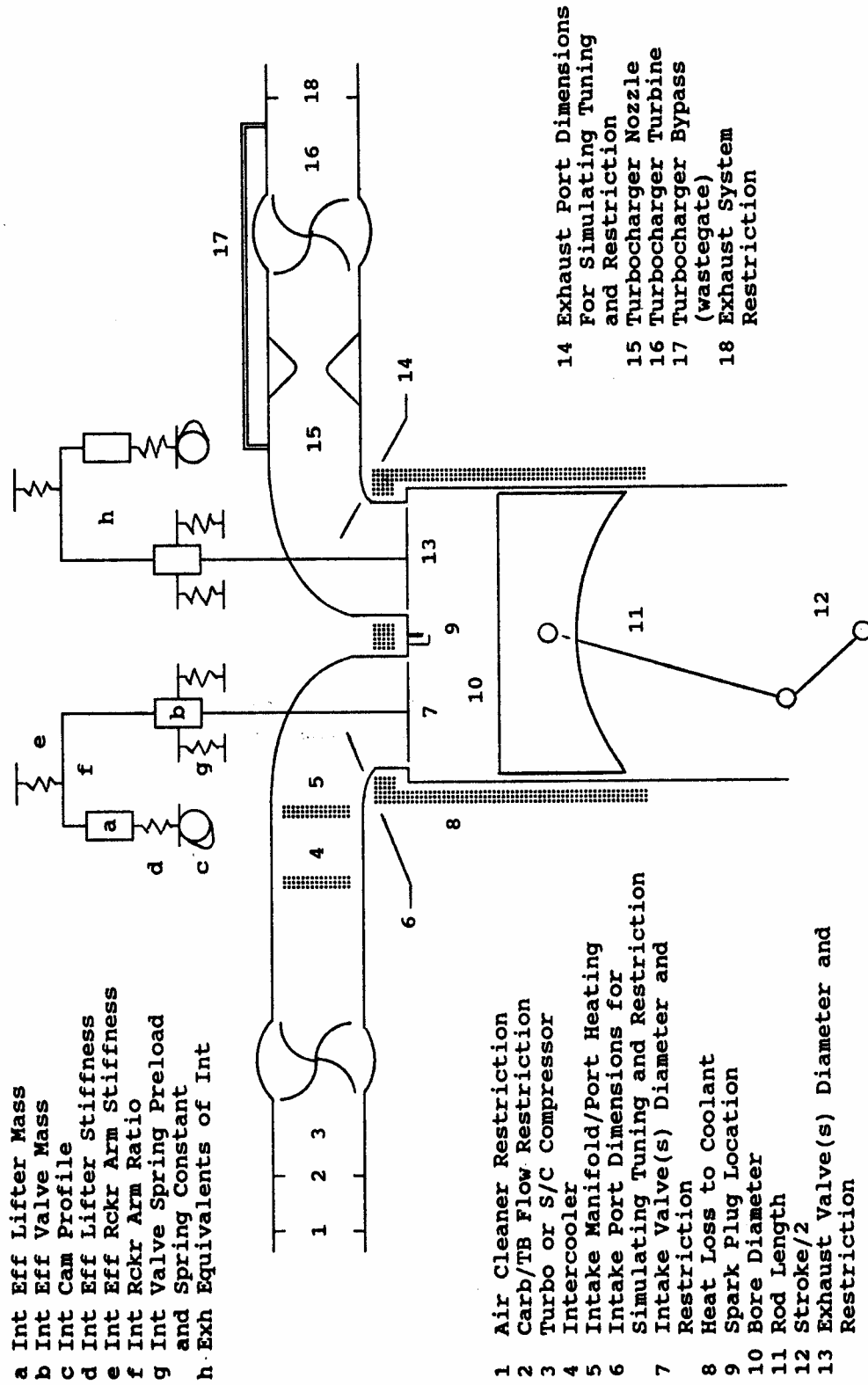

Appendix 2: Summary of 4 Cycle, Internal Combustion Engine Theory

Most performance enthusiasts know the 4 processes which occur in the 4 cycle, internal combustion engine, namely:

- Intake
- Compression
- Combustion and Expansion
- Exhaust

However, many do not fully understand the theory of how these processes make HP, or how you change these processes to make more HP.

Let's look more closely at the Combustion and Expansion part of the cycle, the portion of the cycle which actually makes power. Four cycle, IC (internal combustion) engines produce power from the chemical energy stored in the fuel they burn. This stored energy is released when the fuel burns in the cylinder with oxygen in the air. The heat which is released, heats the air which is trapped in the cylinder, raising its pressure which pushes on the piston and turns the crankshaft. This whole process can be thought of as the "explosion" which occurs when the spark plug fires.

Let's examine the chemical energy in the fuel which is released in the engine. If we look at the engine as just a "black box" (Figure A.7); we do not know what goes on inside, except that fuel goes in and horsepower comes out. We can calculate the amount of horsepower the fuel contains if we know the flow rate of the fuel and the chemical energy of the fuel.

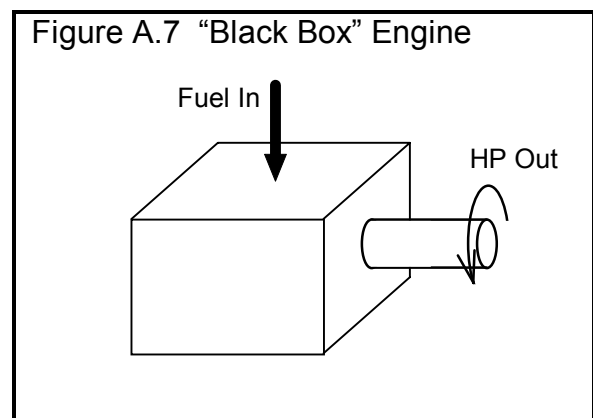

Example of "Black Box" Engine

Fuel Flow Rate = 40 lbs/hr

Chemical Energy in Fuel = 19,000 BTU/lb

Conversion factor: 1 HP = 2544 BTU/hr

HP into "Black Box":

$$(1) \quad \frac{40 \text{ lbs/hr} \times 19,000 \text{ BTU/lb}}{2544 \text{ BTU/hr}} = 299 \text{ HP}$$

If we knew the efficiency of this "black box" engine at converting chemical energy into mechanical energy (HP), we could calculate its HP output. For this example, let's say the "black box" engine is 25% efficient.

$$(2) \quad \text{Efficiency} = \frac{\text{HP out}}{\text{HP in}} \times 100\%$$

Filling in the information we know into eq (2):

$$25\% = \frac{\text{HP out}}{299 \text{ HP}} \times 100\%$$

Rearranging terms:

$$\text{HP out} = \frac{25\% \times 299}{100\%} = 75 \text{ HP}$$

Power out of "Black Box" engine:

$$(3) \quad \frac{\text{F.F.R} \times \text{C.E.F} \times \text{Eff}}{2544} = \text{HP out}$$

Where: F.F.R. = Fuel Flow Rate, lb/hr
 C.E.F. = Chemical Energy of Fuel, BTU/lb
 Eff = Total Engine Efficiency

Using this simple logic, if the efficiency stays the same, all we have to do is pump more fuel into the engine to produce more power. For example, remove the carburetor and dump the fuel directly down the intake manifold. You could pump the gas tank dry in a matter of minutes, but we all know that the engine would probably produce no power at all. The energy in the fuel can only be released if there is enough oxygen available to burn it completely and the fuel and air are well mixed in the right proportions.

Under perfect conditions, it takes about 14.6 lbs of air to completely burn 1 lb of fuel (an air/fuel ratio of 14.6:1, or A/F = 14.6)*. Under these conditions, extra fuel over the 14.6 A/F is wasted and can severely reduce power if extremely rich (A/F ratios richer than 11.0). This wasting of fuel decreases efficiency "Eff". Therefore, to get more fuel into the engine to produce more HP, you must also get more air in so the fuel can burn completely. From this information, we can add something to the equation for the "black box" engine, that HP does not depend on fuel flow, but more importantly on air flow. We will replace the "Fuel Flow Rate" with "Air Flow Rate / Air/Fuel Ratio".

HP from "Black Box" Engine:

$$(4) \quad \frac{\text{A.F.R}}{\text{A/F}} \times \frac{\text{C.E.F.} \times \text{Eff}}{2544} = \text{HP out}$$

Where: A.F.R. = Air Flow Rate, lb/hr
 A/F = Air Fuel Ratio

Although it's easy to get extra fuel into the engine, it is difficult to get more air (oxygen) into the engine. The amount of oxygen the engine takes in for a given amount of time depends on:

- The amount of air the engine can take into the cylinder(s) on one Intake Stroke.
- The # of intake strokes in the given amount of time.
- The density of the air that enters the cylinder.
- The amount of oxygen in the air, which is always 21% , unless you are using nitrous oxide or a fuel which contains oxygen like Alcohol.

The amount of air the engine can take in on one Intake Stroke depends on the number and the size of the cylinders. This is the engine's displacement or CID (cubic inch displacement).

The # of intake strokes in a given amount of time is the engine's speed or RPM/2. RPM is divided by 2 because 4 cycle engines ingest air only once for each 2 revolutions.

The density of the air that enters the cylinder depends on many engine design characteristics, for example intake system restrictions, cam timing, etc. A number which describes how dense the air is which enters the cylinder is the Volumetric Efficiency, or Vol Eff % as it is called by the Engine Analyzer Pro. See Vol Eff % in Section 2.8. These 3 items are what determine the Air Flow Rate in equation (4).

Although 14.6 A/F is the perfect ratio chemically, not every oxygen molecule in the air will "find" a fuel molecule to react (burn) with. Therefore, since air flow is the factor limiting power, extra fuel is added to better ensure every oxygen molecule in the air can find a fuel molecule. For this reason, actual engines run at 11.5-13.5 A/F to obtain maximum power.

$$(5) \quad \text{A.F.R.} = \frac{\text{CID}}{1728} \times \frac{\text{RPM}}{2} \times 60 \times \frac{\text{VE \%}}{100\%} \times .0764$$

Where:

- CID is the cubic inch displacement of the engine
- RPM is the engine speed
- VE % is the volumetric efficiency in % (for the air which actually stays in the cylinder)
- 1728 converts cubic inches to cubic feet
- 60 converts RPM to Revs per Hour
- .0764 is an approximate density of air (lb/cu ft)
- 100 is to convert VE % to a simple fraction

Multiplying all the constants together:

$$(6) \quad \text{A.F.R.} = \text{CID} \times \text{RPM} \times \text{VE \%} \times .00001326$$

Substituting equation (6) into equation (4):

$$(7) \quad \text{HP out} = \frac{\text{CID} \times \text{RPM} \times \text{VE \%} \times .00001326}{\text{A/F}} \times \frac{\text{C.E.F.} \times \text{Eff}}{2544}$$

Now, lets look at the last term in the equation, "Eff". This efficiency term is actually talking about 2 separate efficiencies:

Thermal Efficiency or Thermal Eff, % in the Pro's results : The thermal efficiency is an engineering term that describes how efficiently the combustion and expansion process makes use of the heat energy which pushes on the piston during the expansion stroke. Explaining thermal efficiency can get quite complex for this discussion. However, a simple illustration of thermal inefficiency is the heat left in the exhaust gasses. If the thermal efficiency of the engine were higher, more of the heat of combustion would be used to push on the piston, less heat would be exhausted from the cylinder, and the exhaust would be cooler. The thermal efficiency is quite difficult to improve beyond the range of .40 (40%), with most engines having a thermal efficiency of .25 (25%) to .35 (35%).

Mechanical Efficiency or Mech Eff, % in the Pro's results: Up to this point we have talked only about the amount of work the burned gases or "explosion" does on the top of the piston. This work done on the piston is called Indicated Work or Indicated HP. However, not all this Indicated Work or HP gets out of the engine to the crankshaft. Some of the HP is used up in forms which can be grouped under the title of "Friction" which include:

Where HP is lost to Friction:

- Rubbing, mechanical friction from piston rings rubbing on the bore, bearings rubbing on journals, lifters rubbing on cam lobes, etc.
- Required accessories like oil pump, water pump, cooling fan, etc. (The cam and valve train could be included under this category.)

Rubbing and accessory friction can be illustrated by removing the spark plugs, putting a torque wrench on the crankshaft bolt and turning the engine by hand. The torque required to turn the engine represents torque which could be used to power the vehicle if the engine had no friction.

The work or power lost to friction is called Friction Work or Friction HP and the work which actually appears at the crankshaft is called Brake Work or Brake HP. See Figure A.8.

$$\text{Brake HP} = \text{Indicated HP} - \text{Friction HP}$$

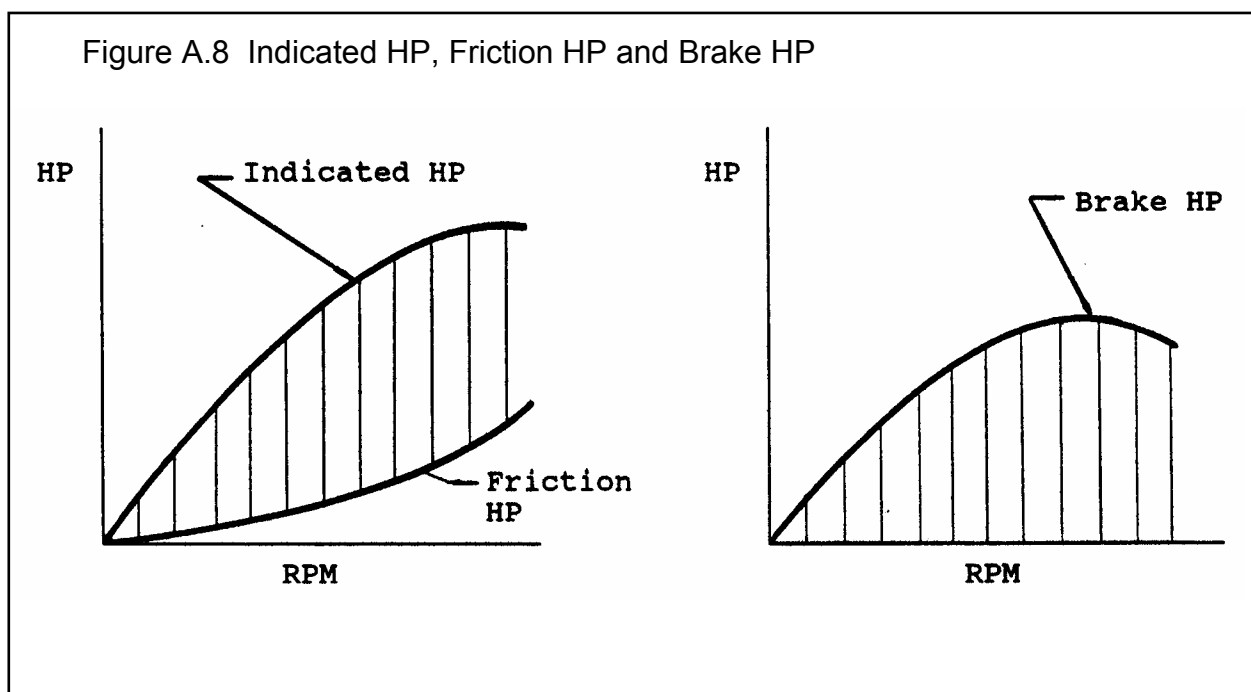

The HP lost to friction can also be expressed as an efficiency:

$$\text{Mechanical Efficiency} = \frac{\text{Brake HP}}{\text{Indicated HP}}$$

Mechanical Efficiencies can be in the range of .00 (0%) up to .90 (90%) or higher. A good illustration of Mech Eff % = .00 is when an engine is idling, clutch disengaged or transmission in neutral. All the HP being generated by the fuel and the "explosions" in the cylinders are producing no BRK HP at the crankshaft. This fuel is being completely wasted, just to overcome the engine's own friction and keep it running.

Multiplying the Thermal Efficiency and the Mechanical Efficiency together is a better way of describing the "Eff" term in the previous equations:

$$\text{Eff} = \text{Thermal Eff \%} \times \text{Mech Eff \%}$$

Substituting this relationship into equation (7) we finally get the formula for HP of an engine:

$$(8) \quad \text{HP out} = \frac{\text{CID} \times \text{RPM} \times \text{Vol Eff\%} \times .00001326}{\text{A/F}} \times \frac{\text{C.E.F.} \times \text{TEFF \%} \times \text{MEFF \%}}{2544}$$

Combining all the constants together, (assuming 14.6 A/F and dividing twice by 100 so TEFF % and MEFF % can be in percents) you get:

Detailed Equation for HP of a 4 Cycle, I.C. Engine

$$(9) \quad \text{HP out} = \frac{\text{CID} \times \text{RPM} \times \text{VOLEFF\%} \times \text{C.E.F.} \times \text{TEFF \%} \times \text{MEFF \%}}{28 \text{ E}12}$$

Note: 28 E12 is "scientific notation" for 28,000,000,000,000. Your calculator will probably not let you enter 28,000,000,000,000, so use the "scientific notation" method.

Now, for the important stuff; what is equation (9) telling us. It's telling us that to make more HP (to raise the value of the left side of the equation) you must raise the value of something on the right side of the equation. Listed below are these factors from the right side of the equation with some explanation, and a list of some specifications from the Engine Analyzer Pro which effect that particular factor.

CID: The cubic inch displacement of the engine:

Bore, inches
Stroke, inches
Of cylinders

RPM: The engine speed:

Stroke (the shorter the stroke, the higher the RPM limit)
Rod length (the longer the rod, the lower the piston Gs)
Anything which lightens reciprocating components extends safe RPM limit.
Other short block specs which affect strength of rotating components
Valve Train Specs which allow high revving without valve toss

VOLEFF%: Volumetric efficiency:

- Most cylinder Head(s) Specs
- Most Intake System Specs
- All Exhaust System Specs
- All Cam Specs
- Most Supercharger Specs
- Weather Conditions and Nitrous Oxide under Calculation Conditions

C.E.F.: Chemical Energy of the Fuel:

- Gasoline/Alcohol
- Possibly Nitrous Oxide

[Note: This is where alcohol and nitro-methane burning engines make additional power over gas engines. When burned, these fuels release more energy per pound of air than gasoline. Nitrous oxide, on the other hand, is only a way to get more oxygen into the cylinder so more fuel can be burned. Technically, nitrous oxide is improving VE % by supplying "air" with more oxygen (for example 30%) rather than the 21% oxygen typical of normal air.]

TEFF %: Thermal efficiency:

- Compression Ratio
- Spark Advance Specs
- Piston Coatings
- Combustion Chamber Design and Coating
- Cylinder Head Material

MEFF %: Mechanical efficiency:

- Most Short Block Specs
- Coolant Temp (effects oil temp and therefore oil viscosity)
- Supercharger Specs (for centrifugal or Roots type, belt driven superchargers)

Appendix 3: Intake and Exhaust Tuning

Intake Inertia Tuning

The intake process of a 4-cycle engine is a cyclic process. During the intake stroke, the piston accelerates a column of fresh air from rest to speeds of up to 1000 ft/sec and then back to rest in only a few thousandths of a second. Decelerating the inertia of this column of air at intake valve closing results in high pressures at the intake valve. This high pressure forces additional fresh charge into the cylinder, like a supercharger, resulting in higher volumetric efficiency and torque. This condition is called inertia tuning. See Figure A.9.

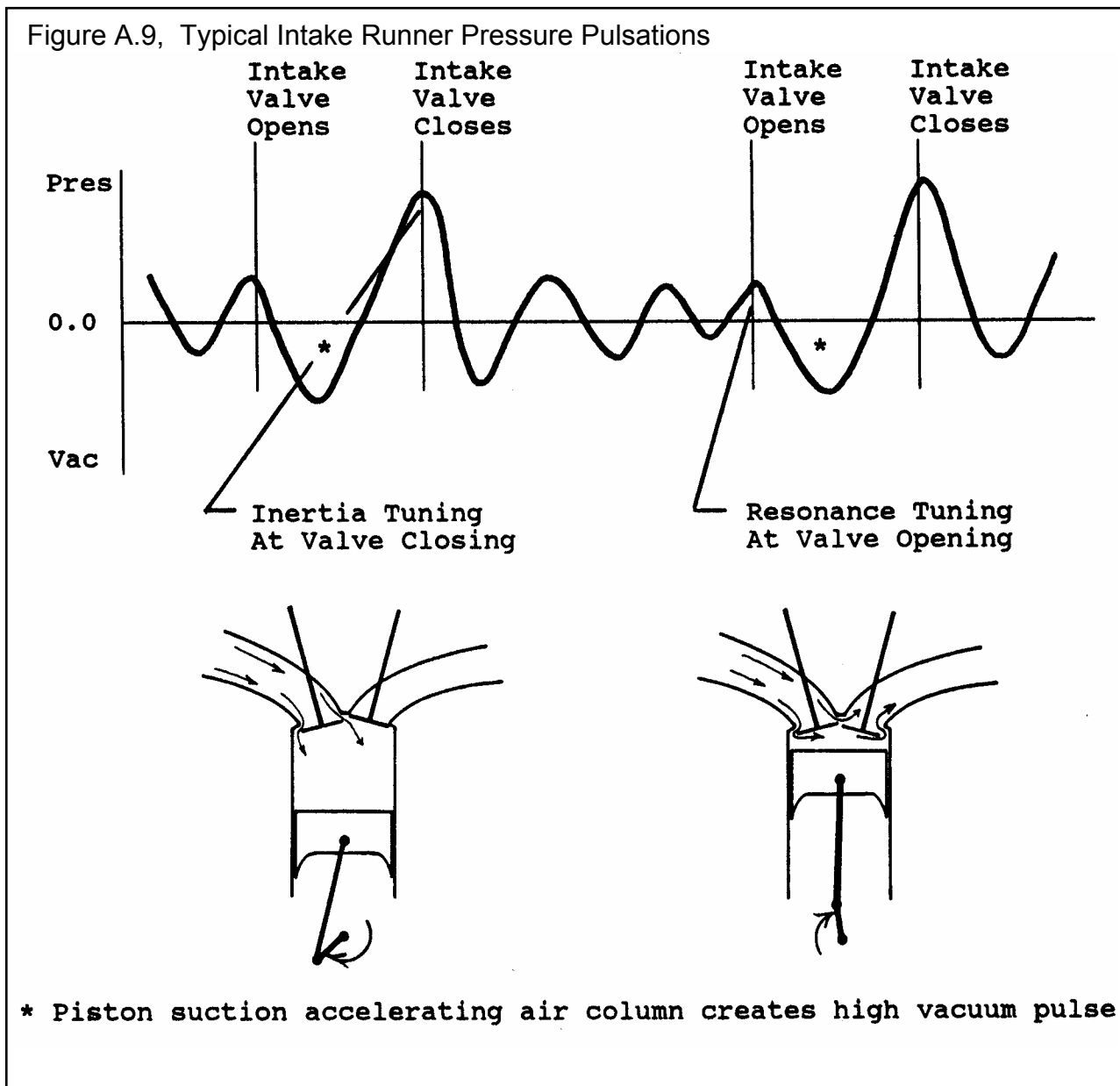

A good analogy of inertia tuning is the "water hammer" effect in old plumbing when you quickly close a running faucet. (New plumbing has "trapped air shock absorbers" to reduce this effect.) Decelerating the column of water in the pipes by closing the valve causes a sharp pressure rise that literally "rattle the pipes". This is the same situation as when the intake valve closes.

Inertia tuning is responsible for an increase in volumetric efficiency and torque over a broad RPM range. See Figure A.10. Inertia tuning is optimum when the rise in intake runner pressure is high over a broad range of the valve opening period, especially around intake valve closing. This usually occurs when In Tune Prs is highest in the RPM data test results. See Example 4.5.

Intake Resonance Tuning

Once the intake valve has closed, this pressure pulsation continues to be reflected back and forth in the intake runner until the intake valve opens and the process starts again. If a high pressure peak of this reflected wave is at the intake valve during valve overlap, it can blow the burnt exhaust gasses out of the clearance volume into the exhaust. This results in additional gains in volumetric efficiency.

However, if a vacuum peak arrives at the intake valve during overlap, additional exhaust gasses will be drawn into the intake runner. This process hurts volumetric efficiency since the cylinder must first draw in that "blown back" exhaust from the intake runner before it starts to induct the fresh, power producing air charge. The timing of this reflected wave to aid scavenging is called resonance tuning.

For typical runner lengths (6-20 inches) and RPMs (3000-10000 RPM), the resonant pressure wave is reflected several times between intake strokes. Therefore, at some RPMs positive intake tuning occurs and negative tuning occurs at other RPMs. Resonance tuning is responsible for the "wiggle" seen in torque curves for engines with high valve overlap. For engines with low overlap, resonant tuning has much less effect. Also, each time this wave is reflected it loses some strength, so at lower RPMs or for shorter runner lengths resonance tuning is negligible. The Engine Analyzer Pro detailed tuning simulations will show these gains or losses in volumetric efficiency and performance for resonance tuning.

Figure A.10, Effect of Inertia and Resonance Tuning On Volumetric Efficiency and Torque.

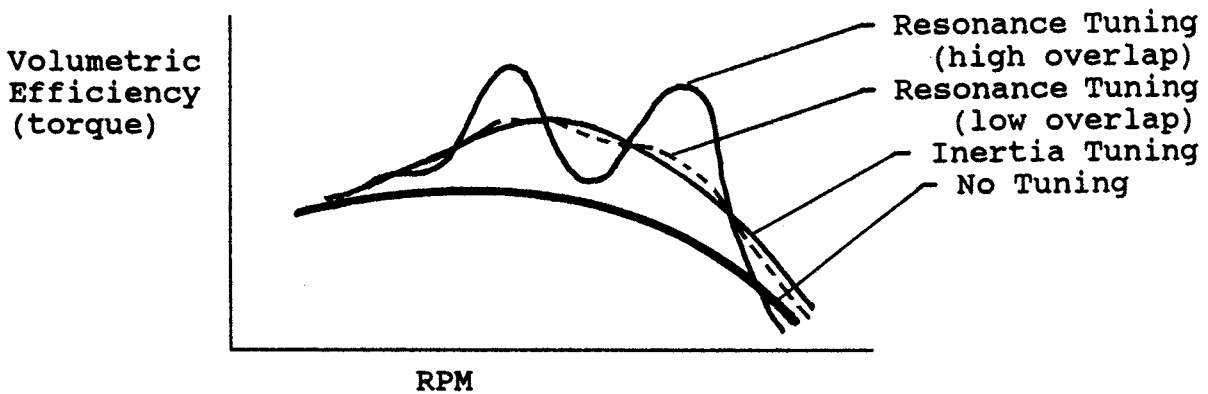

Intake Secondary Tuning

Inertia and Resonance tuning deal with pressure waves present only in the "primary" intake runner. Secondary tuning deals with pressure waves present in a plenum and "secondary" runner ahead of the "primary" intake runner. A good example of secondary intake tuning is the dual plane, V-8 intake manifold. Most engine builders realize that a dual plane will produce good torque at a lower RPM than a single plane. The question is "Why?".

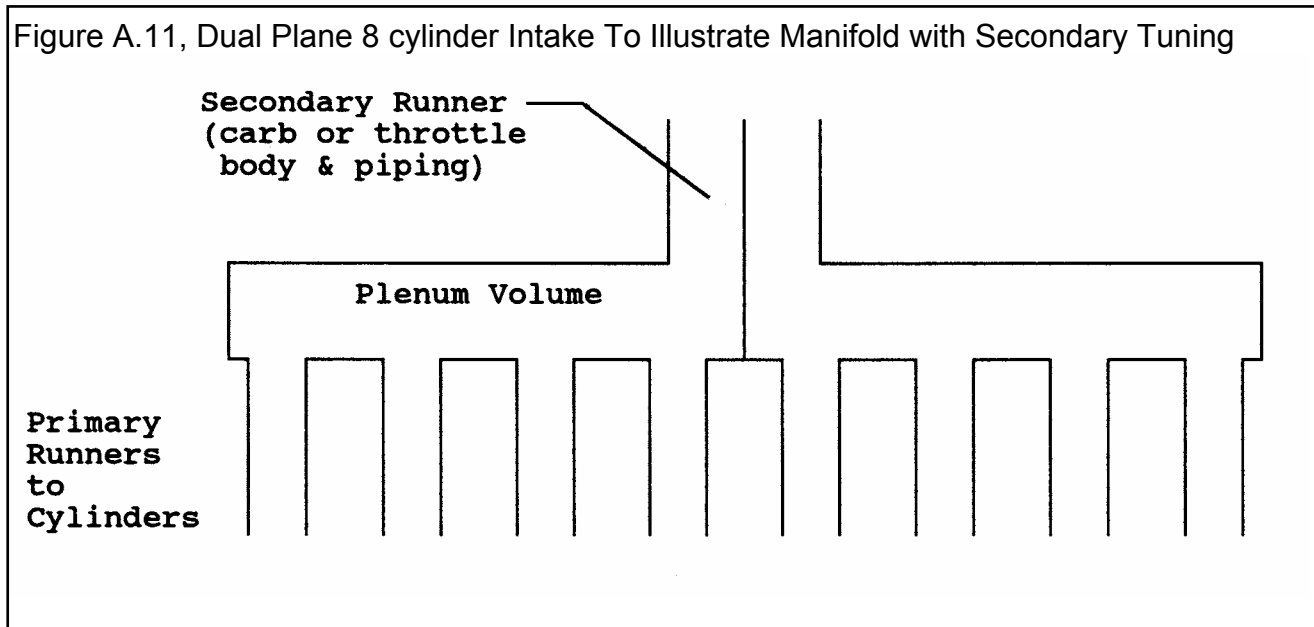

Figure A.11 is a simplified view of a dual plane, 8 cylinder intake manifold. It consists of the primary runners, a plenum, and a secondary runner. In the case of a carburetor, the secondary runner is the carburetor barrel(s) which supply each plane. For fuel injected engines, the secondary runner is the throttle body and any piping before and after the throttle body.

A single plane, 8 cylinder intake also has a plenum and a secondary runner, but it does not display secondary tuning. The reason is that when 8 cylinders all draw on the same plenum, there is much overlap of the pulses. These pulses look more like a constant suction than pulses. With no defined pulses on the plenum or secondary runner, there is no secondary tuning. In general, if more than 4 cylinders are drawing on a plenum, there will be little secondary tuning.

Then why use a single plane intake? This lack of pulses on the carb is one reason the single plane intake is less restrictive at high RPM. A carburetor is less restrictive to a constant flow than pulsing flow. Also, secondary tuning helps at low RPM due to the complex interaction of waves produced in the secondary runners. These complex waves generally "mess up" the simple Inertia and Resonance tuning waves at their tuned RPM (generally high RPM). To summarize, single plane intakes provide better high RPM tuning and are less restrictive.

Secondary tuning is treated in a more simplistic way by the Engine Analyzer Pro than inertia or resonance tuning. The RPM where secondary tuning will be most significant is strongly influenced by the Plenum Specs in the Intake System menu. These specs include the length and area of the secondary runner or carburetor, and plenum volume. Where the # of Cylinders in the Short Block menu is high relative to the Manifold Type chosen, the secondary runner length and area specs will be disabled as there will be no secondary tuning.

Exhaust Resonance Tuning

Things are much more violent in the exhaust runner due to the sudden rush of high pressure exhaust out the exhaust valve when it first opens. In fact most of the exhaust is expelled during this first rush called "blow down". That leaves relatively little for the piston to push out during the exhaust stroke.

Due to this violent "blow down", exhaust tuning is not significantly affected by the previous cycle as in intake resonance tuning. Exhaust resonance tuning is caused by the reflections of the "blow down" pulse in the exhaust runner while the exhaust valve is open. If one of the negative, vacuum pulses arrives at the exhaust valve during overlap, it benefits performance by:

- Clearing out the cylinder of any residual exhaust to reduce "contamination" of the fresh incoming intake charge.
- Preventing reversion by keeping the exhaust flowing *out* of the cylinder and the intake charge flowing *into* the cylinder.
- Letting the intake charge get a "head start" at filling the cylinder, because the exhaust is sucking the intake charge into the cylinder before the piston has moved enough to suck the intake charge into the cylinder.

With high overlap camshafts and good resonance tuning on the intake side, it is possible to completely scavenge the clearance volume of residual exhaust. This provides for very high volumetric efficiencies, and possibly "short circuiting". Short circuiting is when fresh intake charge passes directly through the clearance volume out the exhaust during overlap. Obviously this wastes fuel, but to produce optimum power that may not be important.

As on the intake side, exhaust resonance tuning will produce torque gains when a vacuum pulse arrives at the exhaust valve during overlap. However, a torque loss will be produced when a positive pulse arrives.

As runner velocities increase (smaller pipe diameters), the shape of the exhaust pulses change.

- The primary blowdown pulse gets wider and the arrival of the 1st vacuum pulse gets delayed.
- The amplitude (height) of the blowdown pulse gets higher and generally the suction of the 1st vacuum pulse gets stronger also.

Therefore, the combination of pipe length and diameter are important to determine what pipe should be used for a particular applications. At Performance Trends we are still trying to better understand the details of intake and exhaust tuning. As we improve our understanding and capabilities, we will add these improvements to our software.

Additional Factors Affecting Tuning:

All tuning factors are affected by temperature, since temperature affects the speed of sound. The speed of sound in the runner influences how fast the pulsation's are reflected. Since temperatures are affected by so many factors not simulated by the Engine Analyzer Pro, tuning effects can only be estimates.

The pulsation's produced by other cylinders can affect tuning pulsation's. This is especially true at points where neither the intake or exhaust are at peak tuning, or "off design" points. These influences from other cylinders are simulated only very simply by the Engine Analyzer Pro.

Low restriction runners (high Runner Flow Coef) provide better tuning effects. However, the exact relationship between Runner Flow Coef and tuning strength is not completely developed. Therefore, you are advised to try a range of Runner Flow Coefs for your simulation. For example, if you measure a Runner Flow Coef to be 2.1, also try the calculations at 1.6 and 2.6. If performance changes significantly, you know tuning is critical. However, you are not guaranteed that the estimated performance at Runner Flow Coef = 2.1 is the best estimate of the engine's actual performance. (Exhaust tuning is not significantly affected by changes in exhaust Runner Flow Coef. This a change in the Windows version 2.1.)

Figure A.12, Exhaust Pressure Diagrams Showing Various Types of Tuning

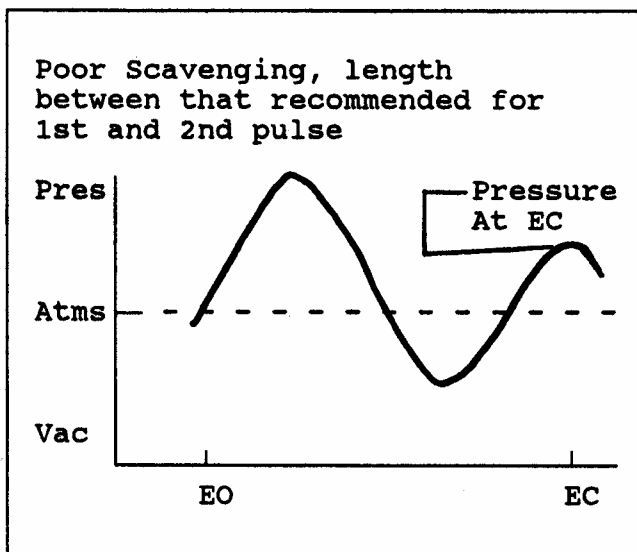
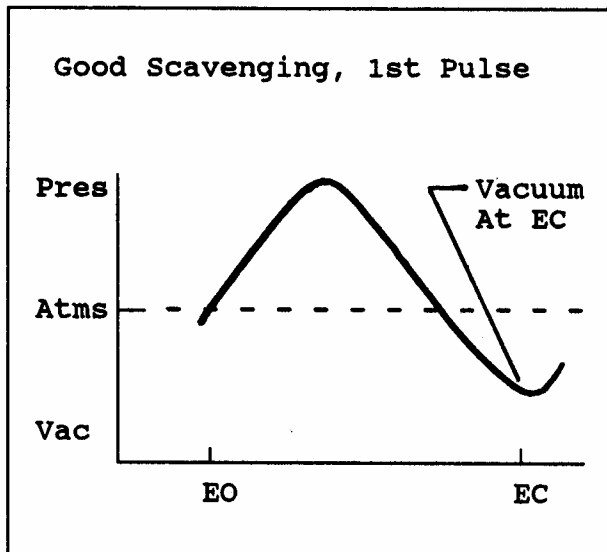
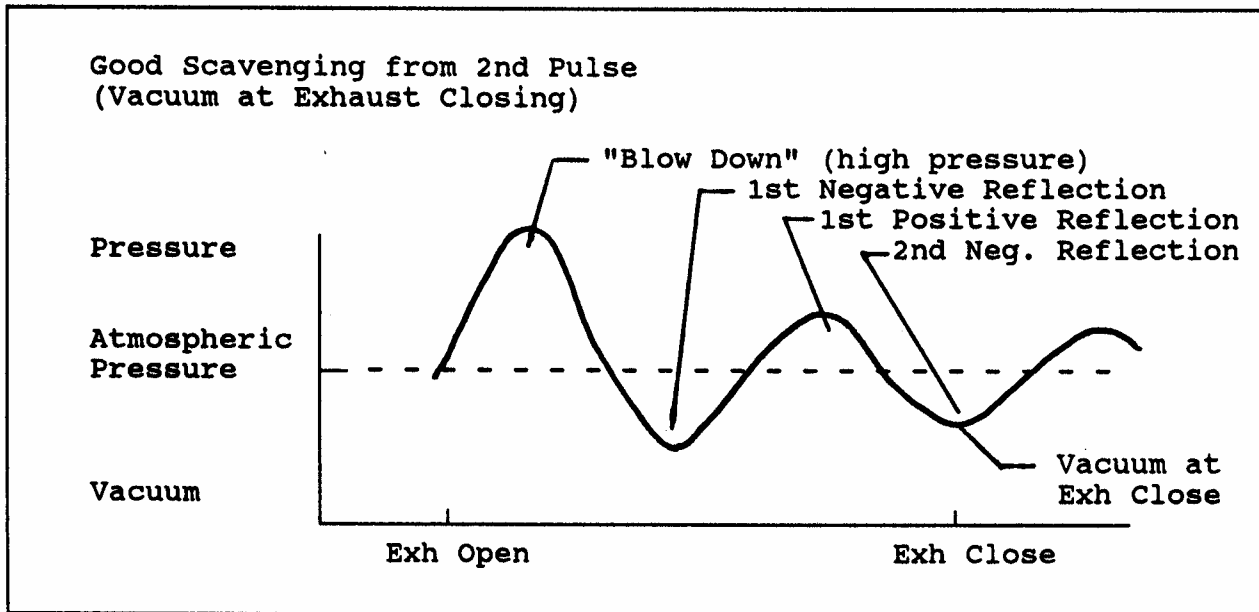

Appendix 4: "Fine Tuning" Torque & HP Curves

The Engine Analyzer Pro was primarily designed to illustrate basic Internal Combustion Engine Theory and give estimates of the "pay back" of certain engine modifications. See Appendix 1. If you are using the Engine Analyzer Pro program to help you make the right decisions for modifying a particular engine and you have dynamometer performance data for that engine, you should first get the Pro calculated results to agree with the dynamometer data.

The suggestions which follow will help "dial in" the engine specifications to match your dynamometer data. These suggestions will also help you tune your engine to give the desired amount of torque or HP at a desired RPM. However, do not assume that just because the Pro's results matches the dyno's results that all the Pro's inputs or predictions are correct. It is always possible you have overestimated some specs and underestimated others.

Also check Example 4.5 and Appendix 3 for how to adjust tuning effects, which can dramatically alter the torque and HP curve.

A new feature in V2.1 for Windows is the Analysis report, where the computer makes several recommendations based on your desired HP peak RPM and general type of engine you are building. See Analysis Report in Section 3.2.

When creating any engine file for a particular engine, it is best to start with an existing file which most closely resembles that engine. Then modify all the specifications to match that engine for the things which you can measure or you know for certain.

For other specifications like Runner Flow Coef, Exhaust System CFM Rating, etc you may not have data to make a calculation. Estimate these values as best you can from the tables or equations provided in Chapter 2. Calculate performance and compare the Engine Analyzer Pros results with your engine's actual dynamometer results (or your desired torque and HP objectives).

First, compare the Pro's *secondary* RPM data results (not torque or HP) to that which has been measured on the dynamometer, i.e. air flow in Actual CFM, Fuel Flow, Motoring HP, Int Vac, Exh Pres and Mach #.

Actual CFM

Actual CFM is the volume of air flowing into the engine. If the dynamometer data has air flow readings, try to match the Actual CFM readings of the Pro's results. Most dynamometer equipment reads out directly in Actual CFM. Actual CFM air flow can be increased by several means, depending on the RPM where the increase is needed.

- To increase CFM at low RPM (with little effect at higher RPM):
 - Reduce Intake Heat to the Manifold in the Intake System menu to allow less heat to be transferred to the intake charge.
 - Reduce coolant temp, deg F to allow less heat to be transferred to the intake charge.
 - Specify a smaller turbo Turbine Nzzl Dia or higher Belt Ratio if supercharged or turbocharged.
- To increase CFM at low RPM (with little effect at higher RPM), cont:
 - Adjust runner lengths to account for temperature and tuning variations.
 - Adjust intake Runner Flow Coefs to alter strength of tuning.

- To increase CFM at high RPM (with little effect at lower RPM):
 - Reduce any intake or exhaust flow restrictions, or increase flow ratings, i.e. Intake System Total CFM Rating, Runner Flow Coef, Exhaust CFM Rating.
 - Adjust runner lengths to account for temperature and tuning variations.
 - Adjust intake Runner Flow Coefs to alter strength of tuning.
 - Increase Roots Supercharger Vol/Rev, Centrifugal Island CFM, Turbocharger Island CFM, higher Belt Ratio, or set a higher Boost Limit if supercharged or turbocharged.
- To increase CFM at low RPM and reduce CFM at high RPM:
 - Increase Cam Advance
 - Decrease any of the cam timing specs, especially the Intake Centerline or Intake Duration.
 - Decrease intake or exhaust Valve Flow Coef or Flow Table readings.
 - Specify longer length and smaller diameter intake and exhaust runners.
 - Adjust runner lengths to account for temperature and tuning variations.
 - Adjust intake Runner Flow Coefs to alter strength of tuning.
 - Specify smaller valve diameters.
- To increase CFM in the mid range:
 - Specify Secondary Throttles as None or Mechanical.
 - Adjust runner lengths to account for temperature and tuning variations.
 - Adjust intake Runner Flow Coefs to alter strength of tuning.
 - Specify short duration or early intake closing cam events, but with high tappet lift or high rocker arm ratios.

Fuel Flow

Fuel flow will generally follow air flow (Actual CFM) if the A/F is constant. If the dynamometer data includes fuel flow in lbs/hr and an actual A/F measurement based on exhaust gas analysis, calculate dynamometer air flow as follows:

$$\text{Actual CFM} = \text{Dyna Fuel Flow (lb/hr)} \times \text{Dyna A/F} \times .218$$

Now you can use the Actual CFM rules to make dynamometer and Engine Analyzer Pro air flows match.

If the dynamometer data does not include a measured A/F, then assume your engine is running at 12.5, just as the Pro assumes. Use the same rules as listed under CFM to get the Pro's fuel flow to match the dynamometer fuel flow. For example, if the Pro's results need more fuel in the midrange to match the dynamometer results, try specifying Secondaries as None or Mechanical as listed under "To increase CFM in the mid range".

Motoring HP

If the dynamometer your engine is tested on can "motor" the engine (spin the engine over at high speed with spark and fuel off), the dynamometer data should include the measured motoring friction HP. This data should be taken with oil and coolant at operating temperature and WOT (wide open throttle). If this data is available, compare it to the Pro's Motoring HP. Motoring HP from the Pro should match relatively well with motoring HP from a dynamometer.

If the measured motoring HP is lower, increase the value of the Short Block specs which increase friction, like Piston Skirt, Bearing Size, Cooling Fan Type, Water Pump & Drive, or Windage.

Int Vac

To the Engine Analyzer Pro, Int Vac is the intake vacuum after the carb or throttle body during the intake stroke. Intake vacuum measurements on a dynamometer are an average over all 4 strokes. Therefore, dynamometer data will (and should) show less vacuum than the Pro's results, especially for individual runner intakes or engines with less than 3 cylinders. However, if the dynamometer data shows more vacuum than the Pro, you may want to increase the Pro's vacuum by reducing Total CFM Rating in the Intake System menu.

Exh Pres

Exh Pres is calculated by the Engine Analyzer Pro so as to correlate well with dynamometer exhaust pressure measurements. If the dynamometer data shows more pressure than the Pro, you may want to increase the Pro's back pressure by reducing Exhaust System CFM Rating.

Mach

Although you can not measure Mach # with a dynamometer test, it can be measured on a flow bench. Accurate flow bench data will give accurate flow coefficients, which are key for accurate Mach #s. Without significant tuning effects, severely restrictive runners, carb or exhaust system, the Mach # primarily dictates torque and HP peaks. The torque peak will occur at a Mach # of approximately .35-.4 and the HP peak at a Mach # of about .45-.55. For example:

Example of Adjusting Torque Peak Using Mach

- The dynamometer data show (or you require) a torque peak at 5500 RPM
- The Engine Analyzer calculates a Mach # of .48 at 5500 RPM
- You should try to lower the Mach # to .4 at 5500 by providing:
 - More intake cam duration or lift
 - Larger intake valve area (increase Valve Diameter or # Valves/Cylinder)
 - Improved intake air flow (increase Valve Flow Coef or Runner Flow Coef)
 - Decrease Bore or Stroke for the same size head

Brk Tq and Brake HP

If you match up the secondary information as shown previously, ideally the torque and HP will automatically match. However, this may not happen or perhaps some secondary information is not available from the dynamometer data. Therefore you are left with matching dynamometer brake torque and HP with Brk Tq and Brake HP from the Engine Analyzer Pro.

Since torque and HP are largely a function of air flow, follow the rules outlined under the Actual CFM category. That is, if the Engine Analyzer Pro needs more torque at low RPM, apply the rules under "To increase CFM at low RPM (with little effect at higher RPM):", for example "Reduce Intake Heat to the Manifold in the Intake System menu".

The other possible avenue which has a large impact on Brk Tq and Brake HP is Motoring HP. If the Pro results show significantly more HP at higher RPM, try increasing Motoring HP as discussed previously.

Differences in Dynamometer Testing Methods:

Variations in dynamometer testing procedures can produce significant difference in measured torque and HP. Some dynamometer tests try to simulate actual vehicle installations, some go for "maximum possible HP". Table A1 shows the differences between typical vehicle installation and dynamometer installation for various Engine Analyzer Pro specifications.

The Calculation Conditions for some engine files reflect vehicle installations using the SAE (Society of Automobile Engineers) standard weather conditions for rating engine power, per SAE Procedure J-1349. However, dynamometer tests going for "maximum possible HP" for racing engines use a different set of standard conditions which result in approximately 4% more power. These "Other Std Conditions" are also typical of the dynamometer conditions used in the 1960s by the automobile manufacturers, which tended to "over rate" an engine's power.

Table A1. Showing the Difference Between Typical Vehicle and Dynamometer Installations

Engine Analyzer Specs	Vehicle	Dynamometer
Engine Specifications		
Cooling Fan Type	Actual	None
Water Pump & Drive	Actual	None
Type of Int Heat	Actual	Actual or Reduced Heat
Exh Header Dia	Actual	(see note 3)
Exh Header Length	Actual	(see note 3)
Exh System CFM Rating	Actual	
Calculation Conditions		
Intake Air Temp, deg F	77	60
Dew Point, Deg F	49	32
Barometric Pressure, "Hg	29.6	29.92
Elevation, ft	0	0
Coolant Temp, Deg F	Actual	Low, i.e. 140-160

Note 1: Typically an electric motor or water pressure is used to circulate coolant, eliminating water pump losses on dynamometer tests.

Note 2: Occasionally the crossover is blocked and the coolant is cooler to obtain optimum torque and HP.

Note 3: Typically headers are installed with no exhaust system to obtain optimum torque and HP.

In general, production engines are dyno tested following the guidelines of the Vehicle column in Table 1A. Race engines are dyno tested following the Dynamometer column.

Appendix 5: Watching Tuning Pressure and Flow

The main way to increase HP is to increase the engine’s volumetric efficiency or ability to breathe air and trap it in the cylinders. One way to allow the engine to breathe more air is to pressurize the intake system like a supercharger does. A pressurized intake system will push more air into the cylinder for every cylinder filling event. Another way is to reduce the pressure on the exhaust side, similar to what open headers do compared to a restrictive, full vehicle exhaust system.

It turns out that you do not have to pressurize the intake system for the whole cycle to get the benefit of a pressurized intake. If you only pressurize the intake, say to 5 PSI for only 30 degrees of rotation right before the intake valve closes you get almost the same benefit as pressurizing to 5 PSI for the entire 720 degrees of the cycle. The same is true on the exhaust side. If you provide low exhaust backpressure only during overlap (when both the intake and exhaust valves are open or right before the exhaust valve closes) you get most of the benefit of running low backpressure.

To increase pressure on the intake system and reduce pressure on the exhaust system, you must first reduce all flow restrictions to a minimum. This includes restrictions like carburetor, muffler, restrictive intake and exhaust runners, and especially restrictive valves and ports.

However, even with *zero* intake and exhaust restriction, volumetric efficiency for a non-supercharged engine could only get as high as 100%. Many race engines have volumetric efficiencies greater than 100%. This is done by taking advantage of the pressure waves which are created in the intake and exhaust runners due to the normal cyclic nature of engine operation. See Appendix 3. The most competitive race engines are developed by maximizing the effect of these pressure waves by proper sizing of the intake and exhaust runners, cam timing and valve flow for the particular engine displacement and RPM operating range. These engines are said to be highly *tuned* and are taking advantage of *tuning* waves in the intake and exhaust.

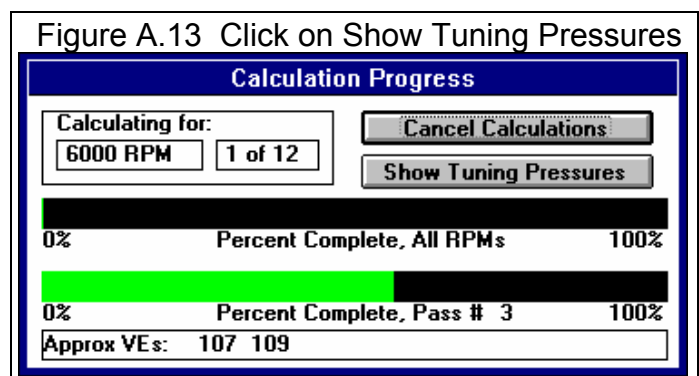

A useful feature in the Pro is the ability to watch these tuning pressures while calculations are being performed. See Section 3.7, See Engine. Click on Show Tuning Pressures button to produce the screen shown in Figure A.14. As said earlier, you only have to have high pressure on the intake side right before the intake valve closes to get a good increase in volumetric efficiency. The example in Figure A.14 shows a wave in the intake port of over 20 PSI absolute, which is over 5 PSI over atmospheric pressure of approximately 14.7 PSI. That is almost as good as running a supercharger with slightly over 5 PSI of boost!

Figures A.15 - A.17 show several examples of Tuning Pressures and Flows screens identifying important points.

Figure A.14 Screen of Tuning Pressures and Flows Showing Good Tuning

Exhaust pressure steadily drops, coming close to exhaust port pressure. After TDC, cylinder pressure follows intake port pressure. Ideally, cylinder and port pressures would match almost exactly, indicating very little flow restriction across the valves.

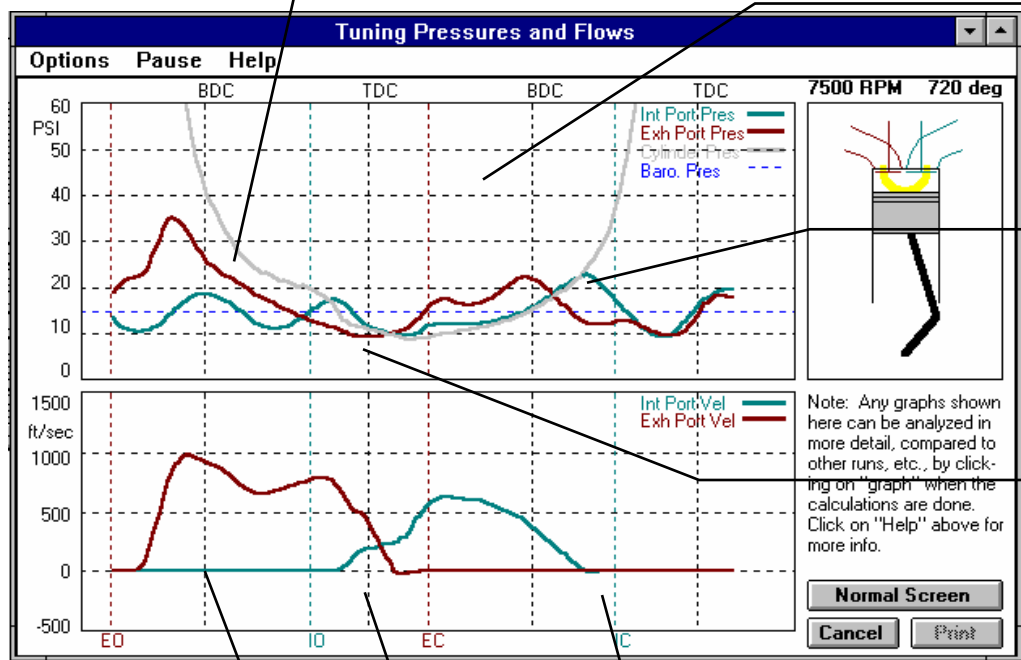

Watch tuning pressures in this graph, where the objective is to maximize intake pressure and minimize exhaust pressure.

Intake pressure close to intake valve closing is very high, over 20 PSI absolute, or over 5 psi higher than normal atmospheric pressure (around 15 PSIA)

Exhaust pressure is low during overlap (between intake opening and exhaust closing) to pull a high portion of exhaust out of the cylinder.

Note: Any graphs shown here can be analyzed in more detail, compared to other runs, etc., by clicking on "graph" when the calculations are done. Click on "Help" above for more info.

A slight amount of reverse flow (velocity goes below 0) is present at intake closing. Too much reverse flow says piston is pushing fresh air & fuel which has entered the cylinder back into the intake port.

Very little reverse flow is seen here for either the intake or exhaust during overlap. This indicates no reversion.

Watch this Velocity graph to watch intake and exhaust flows and which direction the flow is going. Exhaust flow velocities will be higher because the exhaust is much hotter than the intake.

Figure A.15 Runners Too Short for this RPM

Cylinder pressure match exhaust and intake port pressures almost exactly. This indicates very little flow restriction from the port and valve. This is a good thing, and would produce good power if the tuning pressures and/or valve timing were correct.

Reflected vacuum pulse on the exhaust has returned too early, well before overlap. This could be fixed by using a longer exhaust header pipe.

A high pressure exhaust pulse is present during overlap. This causes reversion, or reverse flow. See the velocity graph.

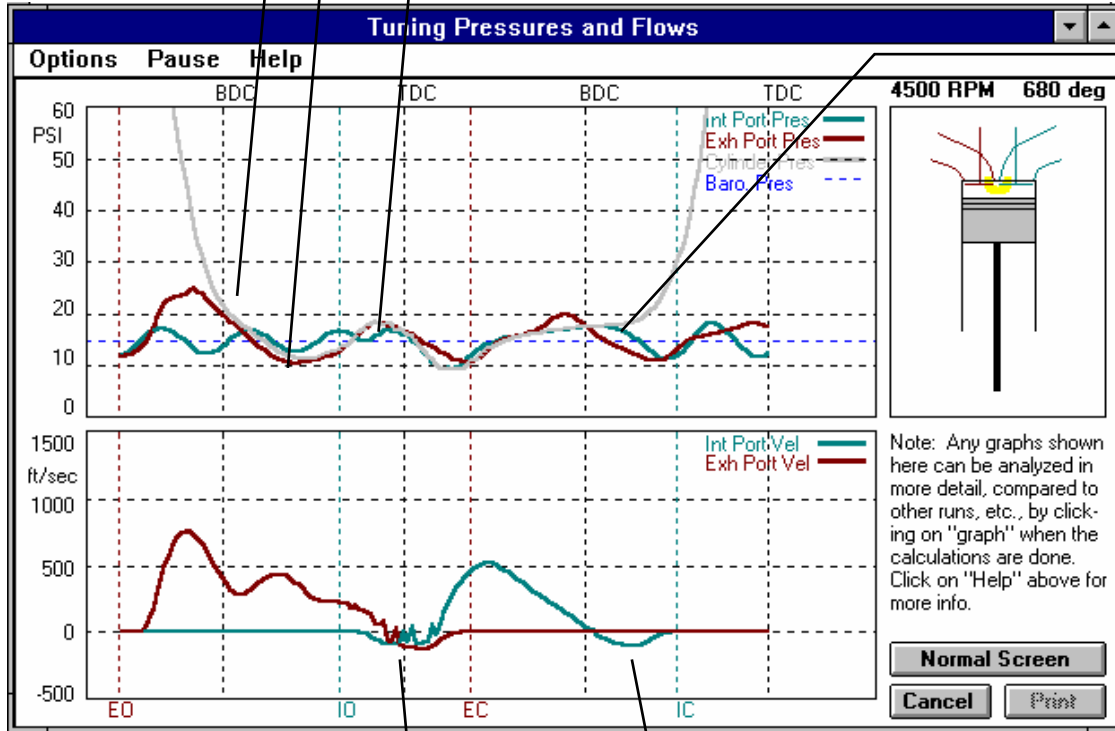

Intake pressure peak is occurring too early, well before intake closing. This is also shown by the reverse flow at intake closing in the velocity graph. The amplitude of this intake wave is also relatively low, indicating a smaller diameter intake runner may be required to produce a high amplitude wave.

Note: Any graphs shown here can be analyzed in more detail, compared to other runs, etc., by clicking on "graph" when the calculations are done. Click on "Help" above for more info.

Normal Screen
Cancel Print

Considerable reverse flow at intake closing because the high pressure intake pulse occurred too early in the cycle, well before the intake valve closed. This could be corrected at this particular RPM with either a longer, and possibly smaller diameter intake runner or by closing the intake valve earlier.

Reverse flow is indicated if velocity goes below 0. Here it goes below 0 for both the intake and exhaust, because there is a high pressure wave in the exhaust port during overlap.

Figure A.16 Runners Too Long for this RPM

Although there is an exhaust suction pulse during overlap, it is not as strong and wide as that shown in Figure A.14. This exhaust header is not necessarily too small a diameter, but too long for this RPM.

Although intake pressure at intake closing is quite high, the low pressure period caused by piston suction is quite long and deep. This intake port is too long for this RPM.

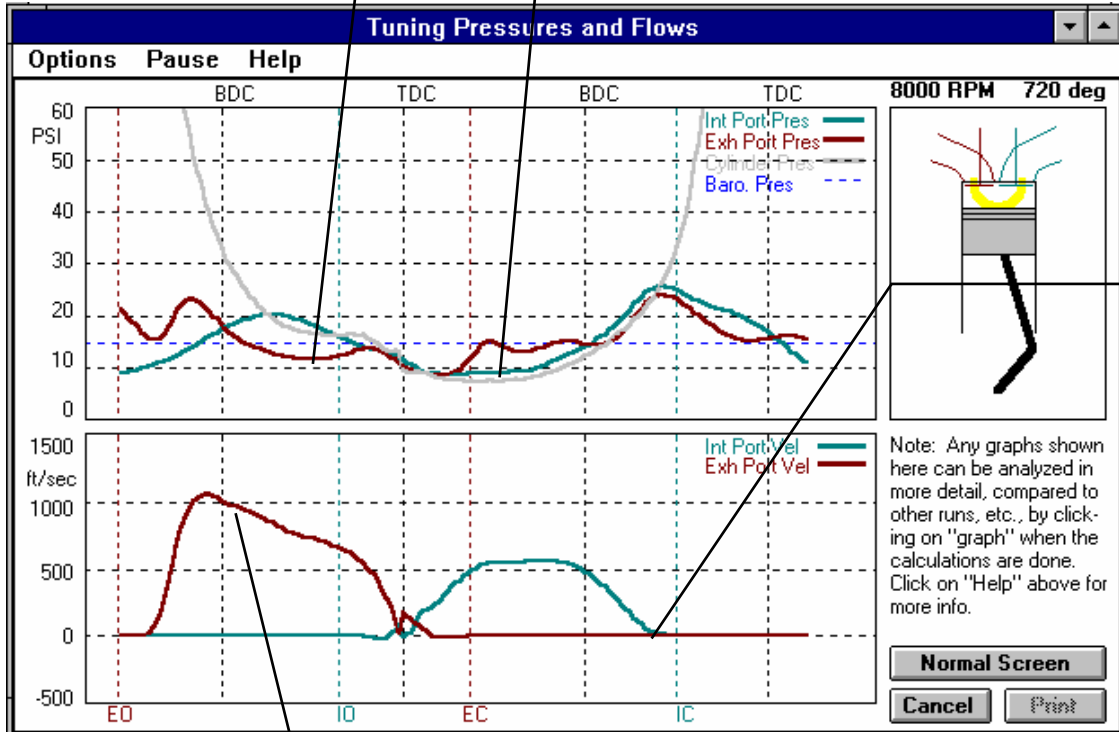

There is no reverse flow at intake closing. Usually best volumetric efficiency is obtained when there is just a little reverse flow at intake closing. See Figure A.14.

Exhaust velocity shows one continuous, large hump. Usually best volumetric efficiency is obtained when there is one hump at blowdown (exhaust opening) and another hump in velocity at TDC (or overlap). See Figure A.14.

Figure A.17 Runners Too Small for this RPM

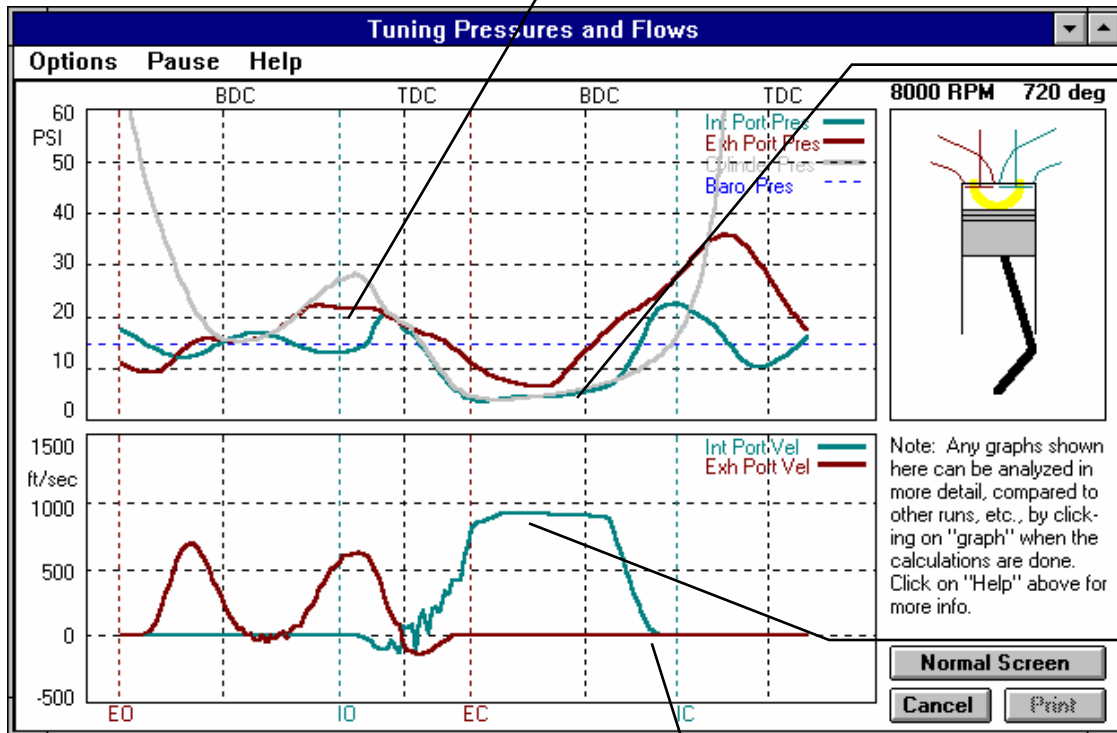

Exhaust pressure during overlap is too high, much higher than the blowdown pulse at intake opening.

Very long and deep suction pulse from piston intake stroke. Pressure never recovers until after BDC. However, cylinder pressure matches intake port pressure quite closely, indicating very little flow restriction from the intake valve

Intake velocity appears limited to a relatively high level, around 1000 ft/sec.

No reverse flow at intake valve closing. A little bit is desirable.

Figure A.18 Valves and Ports Too Restrictive

A restrictive exhaust valve is easy to spot because the the large difference in exhaust port pressure and cylinder pressure.

A restrictive intake valve is less obvious, but is seen here by a relatively large difference in intake port pressure and cylinder pressure at mid stroke, where piston speed is the greatest.

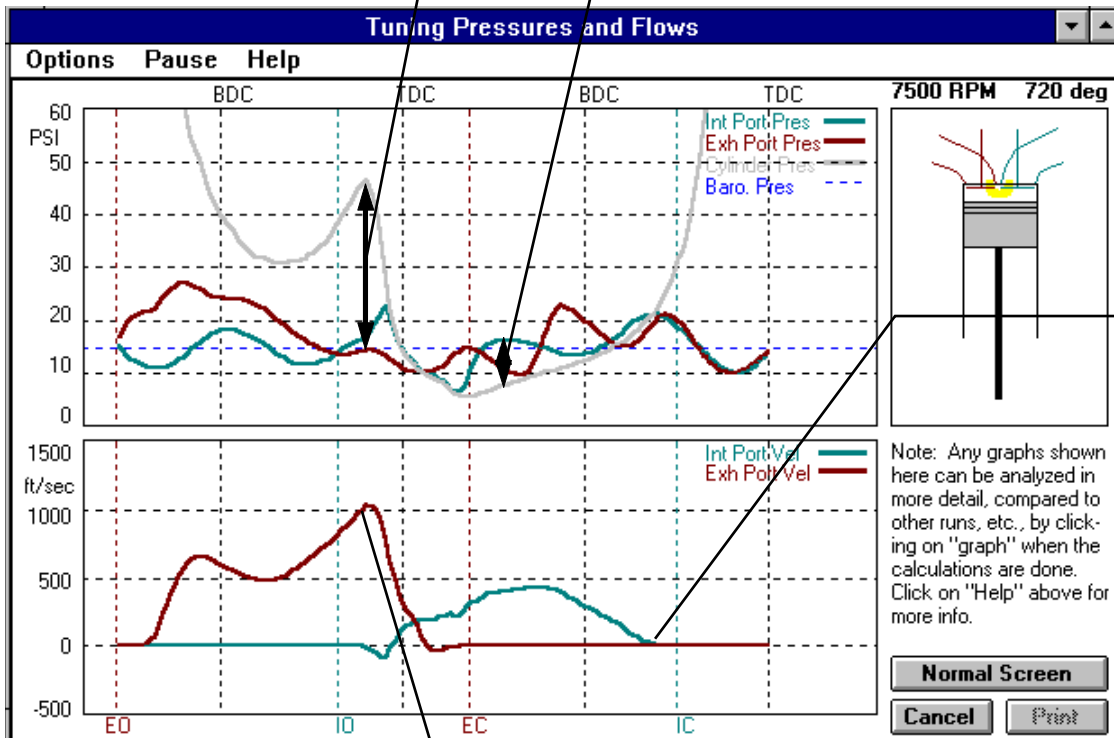

Again you see that there is no reverse flow at intake closing.

Exhaust port pressure is higher at BDC (botton dead center) than at blowdown. This is showing that the piston has to push most of the exhaust out of the cylinder rather than having high exhaust pressure blow the exhaust into the exhaust port at blow down (exhaust valve opening).

Figure A.19 Tuning Pressures when Supercharging

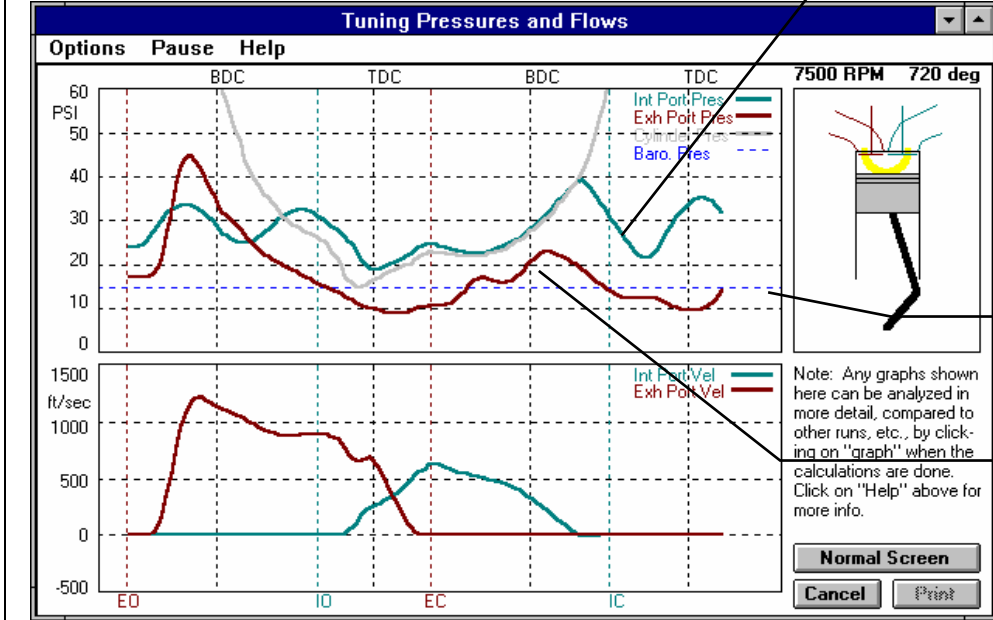

When supercharged the intake pressure graph is shifted up by the amount of boost pressure. Notice that the tuning waves are still present, but intake pressure is always well above the Barometric Pressure line.

Barometric Pressure in PSIA.

If this engine were **turbocharged**, exhaust pressure would also have been raised by the amount of exhaust pressure driving the exhaust turbine.

It is also possible to compare tuning pressures or flows from one condition to another using graphs. For example, Figure A.20 shows a Single Data Graph of ExPort Pres (exhaust port pressure) for 2 diameters of exhaust header. This is the same graph as exhaust port pressure in the upper graph in the Tuning Pressures and Flows screen, except without the barometric pressure line and intake and exhaust opening and closing lines. Here you see the smaller diameter exhaust header produces much more exhaust pressure during overlap, which would hurt performance.

Figure A.20 Comparing Tuning Data

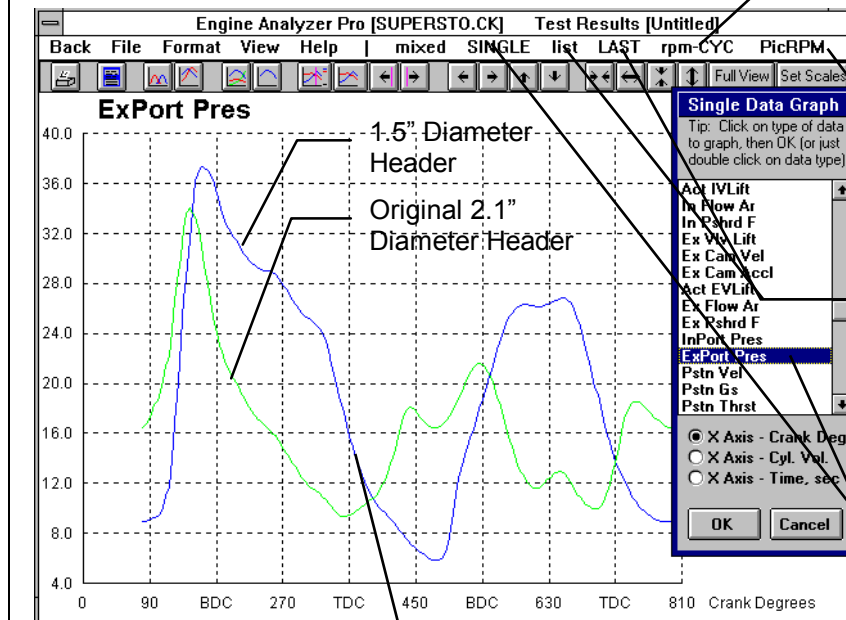

Select Cycle Data type graph

Select the RPMs you want to compare in the graph.

Select what you want to compare to the current test, either the last test, a test from the common list, or a different RPM from the same test (list and last must then be turned off).

Click on Single Tuning pressure or velocity to graph, in this case it was exhaust port pressure.

Smaller diameter header produces higher exhaust pressure during overlap, hurting performance.

Appendix 6: Why So Many Inputs

If you have used other engine simulation software, you will notice that the Engine Analyzer Pro uses many more inputs than other programs. For example, you may wonder why we would ask for "anti-reversion", especially when we say that most heads (ports) have 0 anti-reversion. The Pro does not need to know the anti-reversion of the head to accurately predict the engine's performance potential. It could simply make the assumption that there is 0 anti-reversion and be approximately correct for all current heads.

Performance Trends does not know from where the next major breakthrough in engine technology will come. But, by giving you freedom to simulate numerous unusual engine conditions (so many different inputs), you could possibly discover a breakthrough on the computer. This is the only way to try radically new designs without actually building and dyno testing them.

For example, 40 years ago, no one thought tire growth or clutch slippage was important in drag racing. That was before the development of new technologies like "wrinkle wall" slicks, and "slider" clutches. If computer simulations had been available in the 1950s which let you simulate tire growth and "slider" clutches, racers could have simulated these parts before they were invented. Once they saw that the computer predicted better ETs, they would have developed the parts.

In other words:

Computer simulations should lead the technology breakthroughs by allow you to simulate running conditions which are not yet possible with existing parts.

Simulations which only follow what is already being done can be useful to the novice racer who is content to follow what the innovators are doing. But they will not allow for new designs because there are not enough inputs which consider innovative designs.

Theoretical vs Empirical Models:

This brings up another point, the difference between a "theoretical" model and an "empirical" model. An empirical model is based on past history, like the equations which predict HP per cylinder from intake valve air flow. These are based on experience with flow testing lots of cylinder heads and then dyno testing the engines.

A good analogy to an empirical model is a book with lots of dyno curves with descriptions of the engines. You try to find an engine description in the book close to your engine and then see what power it produced. Sometimes, mathematical "regression" techniques are used fill in the gaps between these dyno curves.

Empirical models can be quite accurate if you are doing things similar to the developer of the model was doing (same fuel, same cam profile, same header design, etc.) However, if you want to simulate something which the developer of the model has not tried, you are basically "on your own".

The Pro is mostly theoretical, which means it is based on numerous laws (equations) of basic physics, like $\text{Force} = \text{Mass} \times \text{Acceleration}$. These equations are then "tuned" to better fit known engine data.

A good analogy to a theoretical model would be cardboard cutouts of a 4 link, rear suspension. The cardboard strips represent the different links and pins locate the pivot points. You can move the cardboard axle up and down and watch pinion angle change.

A good test of a theoretical model is "does the model tell you things that the developer did not know". For example, does it know that you get about a 4% performance improvement by increasing compression ratio 1 point without the developer telling it. If the developer has told it, then it is probably an empirical model. If it gives the correct result without being explicitly told, then it is probably a theoretical model.

Theoretical models can accurately simulate real engines. However, their big advantage is they can also simulate engines which the developer has never tested. This could be a Jaguar V-12 when the developer has never seen a dyno curve for a V-12. Or it could be an engine from the future. For example, it could simulate heads with 100% anti-reversion (which allow no reversion of exhaust back into the intake runner), even though no one has ever built these heads.

Clearly, future breakthroughs in engine building can only come from "cut and try" on the dyno or from "cut and try" with theoretical engine models.

Note: "Anti-reversion" was picked as only 1 example of some to the Pro's detailed inputs. The Pro' has numerous of other inputs which allow the engine builder to try innovative designs.

Appendix 7: Copying Files

There are many times you may want to copy files to or from the Engine Analyzer Pro. Examples would be:

- Copying Cam Dr files from a floppy disk received from a cam grinder.
- Copying engine or component files between Engine Analyzer Pro programs on different computers.
- Copying ASCII files produced by the Engine Analyzer to the directory of a spread sheet program.

Windows 3.1

- Open File Manager (usually in the Main program group)
- Click on Help from the Menu bar, then on Search, then type in the word COPY and click OK. This will give an overview of copy commands.

Here's an example of copying a Cam Dr file from a floppy disk in the A drive to the CAMFILES directory (the directory where the Engine Analyzer Pro first looks for cam profile files) on the C drive.

- Find the Disk Drive and directory you want to copy the file *to* and click on it. In this example that would be the CAMFILES directory under the EAP directory under the PERFTRNS.PTI directory on the C drive.
- If you clicked on CAMFILES, it should be highlighted on the left side of the File Manager window, and the files in that directory should be listed on the right side. This is now the default directory.
- Click on the A disk drive icon in the upper left corner. Find the Cam Dr file you want to copy. Click on it, hold the mouse key down, and drag it to the C disk drive icon. This will copy the file to the default directory on the C drive.

Windows 95

- Click on Start, Programs, Windows Explorer.
- Click on Help from the Menu bar, then on the Index tab, then type in the word COPY and click Yes. This will give an overview of copy commands.

Here's an example of copying a Cam Dr file from a floppy disk in the A drive to the CAMFILES directory (the directory where the Engine Analyzer Pro first looks for cam profile files) on the C drive.

- In Windows Explorer, find the Disk Drive and folder you want to copy the file *to* in the list on the left called All Folders and click on it. In this example that would be the CAMFILES folder under the EAP folder under the PERFTRNS.PTI folder on the C drive.
- Find the Disk Drive, Folder and Cam Dr File on the A drive in the All Folders list on the left. You should see the Cam Dr file on the right side called Contents.
- Click on the Cam Dr file, hold the mouse key down, and drag it to the list on the All Folders list on the left. While holding the mouse button down, find the CAMFILES folder. If it has moved off the screen at the top or bottom, move the mouse icon to the top or bottom. The list of All Folders will scroll by until you see CAMFILES. When you see CAMFILES, move the icon over it and release the mouse button.

Appendix 8: Cam Calculations

The Engine Analyzer Pro's simple cam profiles (not using cam files) requires intake and exhaust cam duration or timing events at .050" lift from Base Circle at the tappet or follower. It also uses Max Lift from Base Circle in Inches Measured At the Tappet or Follower. See Section 2.6.

Many cam grinders give exactly this information. However, some give different specifications. The guidelines below will help you convert other types of cam specs to the units required by the Engine Analyzer Pro.

Notes:

These specifications are also available from measurements of the valve train using a dial indicator and a degree wheel. Performance Trends' Cam Analyzer helps with this process. However, these procedures are beyond the scope of this manual, but are available from cam grinders, engine builders and "speed shops".

The calculations below assume cam profiles are symmetric around the Max Lift or Lobe Centerline point.

"Advertised" duration and events are assumed to indicate the points where the lash is eliminated and the valve just starts to open or close. Occasionally, a cam grinder will call the .050" duration or events the "advertised" duration or events.

Estimate Duration at .050" Given Advertised Duration:

Mechanical, flat tappet

$$\text{Duration @ .050"} = \text{Advertised Duration} - 40$$

Mechanical, roller

$$\text{Duration @ .050"} = \text{Advertised Duration} - 32$$

Hydraulic, flat tappet

$$\text{Duration @ .050"} = \text{Advertised Duration} - 56$$

Hydraulic, roller

$$\text{Duration @ .050"} = \text{Advertised Duration} - 44$$

Estimate Lobe Centerline from Duration and Overlap:

$$\text{Lobe Centerline} = \frac{\text{Advertised Duration} - \text{Advertised Overlap}}{2}$$

$$\text{Lobe Centerline} = \frac{\text{Duration @ .050" lift} - \text{Overlap @ .050" lift}}{2}$$

Calculate Max Lift At Tappet Given Max Lift At Valve and Rocker Arm Ratio:

$$\text{Max Lift at Tappet} = \frac{\text{Max Lift at Valve}}{\text{Rocker Arm Ratio}}$$

Appendix 9: New Features in Version 3.3

Engine Analyzer Pro has had many updates since this user manual was written for the original v2.1 for Windows. These include v2.1 B, v2.1C, v2.1D and now v3.3. Here is a brief listing of some of the features new in these versions, including Version 3.3:

- Program is now a 32 bit version, fully compatible with newer operating systems, starting with Windows, 95, then 98, Me, XP, and 2000. This also allows you to use much longer, more descriptive file names for saving engines, heads, etc. It is also more compatible with newer printers.
- The program is now designed for 600 x 800 or higher resolution screens. Screen colors are also more compatible with Windows XP.
- On the main screen, you now have a "View Comments" button where you can view and modify comments for the Total Engine File and all Component Files.
- There is now a separate "Examples" folder for example engine and component files provided by Performance Trends. New engine and component files which *you* save will be saved to a separate folder.
- File commands to save an engine or component file to a floppy disk or CD, or open a vehicle file from a floppy disk or CD. This allows easy transfer of files from one computer to another.
- You can now choose to list engine and component files alphabetically (as normally done) or by saved date, with the most recently saved files listed first. This should make it easier to find recent files more quickly.
- When Opening Files, the program now lets you list only files with certain letters in their name, like 'Chev' or 'Ford'. This lets you find files faster.
- Hundreds of new example parts have been added, including the entire Crane Cams Catalog, Brodix, AFR, Edelbrock, World Products, Dart and TFS heads, more Import parts, motorcycle parts and kart parts, and more.
- Several new Example Complete Engine Files have been added.
- Program now reads Engine Analyzer v 3.0, 3.2 and 3.2+ files and examples.
- The user's manual is now available from inside the program by clicking on Help at the top of the main screen, then Display User's Manual. The manual is in a high quality PDF format
- The Performance Trends website is now available from inside the program by clicking on Help at the top of the main screen, then Performance Trends on the Web.
- Engine Dimensions can now be entered as either inches or millimeters.
- History Log keeps track of tests you have made, making it easier to recall engine specs or pick tests for making graphs.
- The calculation accuracy has been "tweaked". Most evident changes are:
 - Spark Knock Index has been adjusted to be more realistic.
 - Revised the BSAC calculation to be more consistent with fuel flow (not change so significantly 'with weather conditions as done in earlier v3.0).
 - Very Rich gas as fuel option to help to reduce detonation.
 - Duration at .200" lift is now shown in the Cam/Valve Train screen for the combination of cam specs you have specified.
 - Short Block screen now shows Bore/Stroke and Rod/Stroke calculations.
 - Short Block screen now has Calc menu for finding the Bore or Stroke which will produce a certain desired engine displacement.
 - Several new restrictions have been added for the intake system, including Air Meter, Restrictor and Intercooler.
 - From better information than we previously had, the Coolant HP is now reduced and more accurate.
 - Cheater cam profiles (flat nose with limited lift and aggressive ramps) so you can get most any .200" duration by specifying a varying amount of 'Degree Dwell'.
 - The 'Flow Coefficient' of the ports can now be calculated from up to 3 flow/lift points. Using a full Flow Table is still the most accurate way of defining the flow of the port.
 - Alternate fuels like Propane, CNG (compressed natural gas, methane) and various types of diesel.
 - Program now allows for Chassis Dyno torque, where torque and HP are reduced by a certain percentage to simulate results from a chassis dyno. This input is in the Calculate Performance Conditions screen and must be activated via a Preference in the Preferences menu.
 - Added Ring Land specs for the Compression Ratio Calculation screen.
 - Intercooler effectiveness can now be picked in 5% steps (previously it was 25% steps).

- Program now allows a wider array of Bearing Size Coefficients, more typical of 6 and 4 cylinder engines and other small engines.
- The Calculation Menu for Bearing Size Coefficient now allows for estimates for roller bearings (typical of small, motorcycle or Kart engines).
- A Preference allows you to have the program more closely match the results from the old v2.1D, rather than giving what we believe are the slightly more accurate results of v3.3. This can be handy for users who have a great deal of experience with v2.1 D.
- A Preference allows you to display either a Heat Release curve or Carb Metering Signal in the Cycle Data results. The heat release curve is new to v3.3.
- Two new Preferences allow for Valve Toss or Lifter PumpUp to either always show a power loss (typically a good setting if you are not studying Valve Train Dynamics), or to allow the engine to breath better if the valves are open significantly more. This is the setting to use if you are trying to simulate “controlled valve toss” as done with some small Kart engine cams.
- User defined Spark Curve now allows for 4 break points, increased from just 2 in v2.1.
- A header Primary pipe can now have 2 steps and you can specify exactly the lengths of each step.
- New Turbo “Turbine Eff, %” options for ball bearings, allowing boost to come on sooner.
- Revised some turbo performance calculations after the wastegate comes on (show less performance).
- Dyno Inertia in the Short Block specs is now more accurate when you do an accelerating dyno test.
- Burn Rating replaces Swirl as an input in the Head Specs menu, and has several more choices for better fine tuning.
- Several features have been added to the graphs, including:
 - The graph screen is now larger, and generally fills the entire screen.
 - The Graph cursor now interpolates between points. This means that if one power curve has results at 2000, 2400 and 2800 RPM, and another has results at 2000, 2500 and 3000, the cursor will read both curves at all RPM points you ran, 2000, 2400, 2500, 2800 and 3000.
 - TDC and BDC labels are now displayed on the Cycle Data graphs. If you are using a cursor, the cursor value is also given as, say “24 deg ABDC”.
 - A Preference lets you turn off the Graph always AutoScaling a new graph. This means that if you have found a set of scales you like, the program will maintain them.
 - You can right click on the graph line labels to hide that particular Graph Line to reduce clutter on the screen. Right clicking again will have the graph line reappear. There is also a menu item under "View" on the Graph Screen so you can Hide or Restore hidden graph lines.
 - You can now save combinations of scale settings, like max and min RPM (X axis) and max and min torque and HP (Y axis) for easy retrieval in the future. This makes comparisons of printed graphs much easier if they are always printed to the same scales. This is done by clicking on the Set Scales button (right side of Graph Screen), and using the "Open Saved Settings", "Save Current Settings" or "Delete Saved Settings" menu options. Note that you must turn AutoScaling Off for these features to work.
 - You can click on the graph line labels (left, normal button) and that line will flash so you can identify it easily.
 - New Printing options for graphs, including “Dot Matrix Printer Adjustment”, Width adjustments and more (in Preferences).
- New Printing options for reports, including different Font Sizes and omitting the “Starting Point Suggestions” for cam and runner dimensions (in Preferences). The “Starting Point Suggestions” often misled users into think they were more accurate than what their name implied, that they were just a suggested Starting Point from which you should start optimizing using the program.
- Version 2.1 let you send a power curve to a vehicle program to be loaded and run in that vehicle. Version 3.3 lets you do that also. However, that process requires several key strokes and time. Version 3.3 lets you “Auto-Link” with a vehicle program of your choosing. Auto-Link runs every power curve you produce through a vehicle program, and produces a summary of the results. Now you can instantly see how a cam change, head swap, more nitrous will affect ET or circle track Lap Times. At the time of printing this manual, Auto-Link was only available for the Drag Racing Analyzer v3.2 and Circle Track Analyzer v3.2.
- Added a Factor button to Flow Table screen so you can increase or reduce all flows by a certain percentage.
- You can now enter either Tappet Lift or Valve Lift in the Cam Specs screen and the other input is automatically calculated based on the current Rocker Arm Ratio.
- You can now pause the Tuning Pressures screen at the end of each RPM step, when the final results for that particular RPM have been reached. You can now Maximize the Tuning Pressures screen to fill your entire computer screen for better viewing. Click on the maximize button in the upper right corner for this option.

- Hemi and 4 valve cylinder heads are now drawn more correctly in the "See Engine" screen where you watch piston and valve movement and interaction.
- Valve Angles and other specs concerning Piston-To-Valve clearance in the See-Engine screen are now saved in the Head Specs screen. You can view them by clicking on the Angles button. Note that most example Head files and your old v2.1 files will not have these specs entered correctly or they will be blank.
- The program is now using a more stable computer hardware #, so that minor changes to your computer settings will not require you to get a new unlocking number.
- A new preference lets you customize the Test Results Summary. You can choose either Peak Tq & HP @ RPM with Average Tq & HP (like old v2.1) or you can show a comparison of Peak and Avg Tq & HP (no RPM) for the current test and the previous test you selected to saved.
- A new Preference allows you to change the relative size of the "Special Calculations" section of the output screen, Standard, Small, and Very Small.
- On program shut down, the program now asks if you want your changes saved to the "Library Copy" of the file you are working with.
- The Engine Analyzer Pro can now read several cam file formats, including Cam Dr™, Cam Pro Plus™, S96, Doctor Dr, Competition Cams™, and Andrews™.

Figure A20 List Engine Files by Date Last Changed in Open File Screen

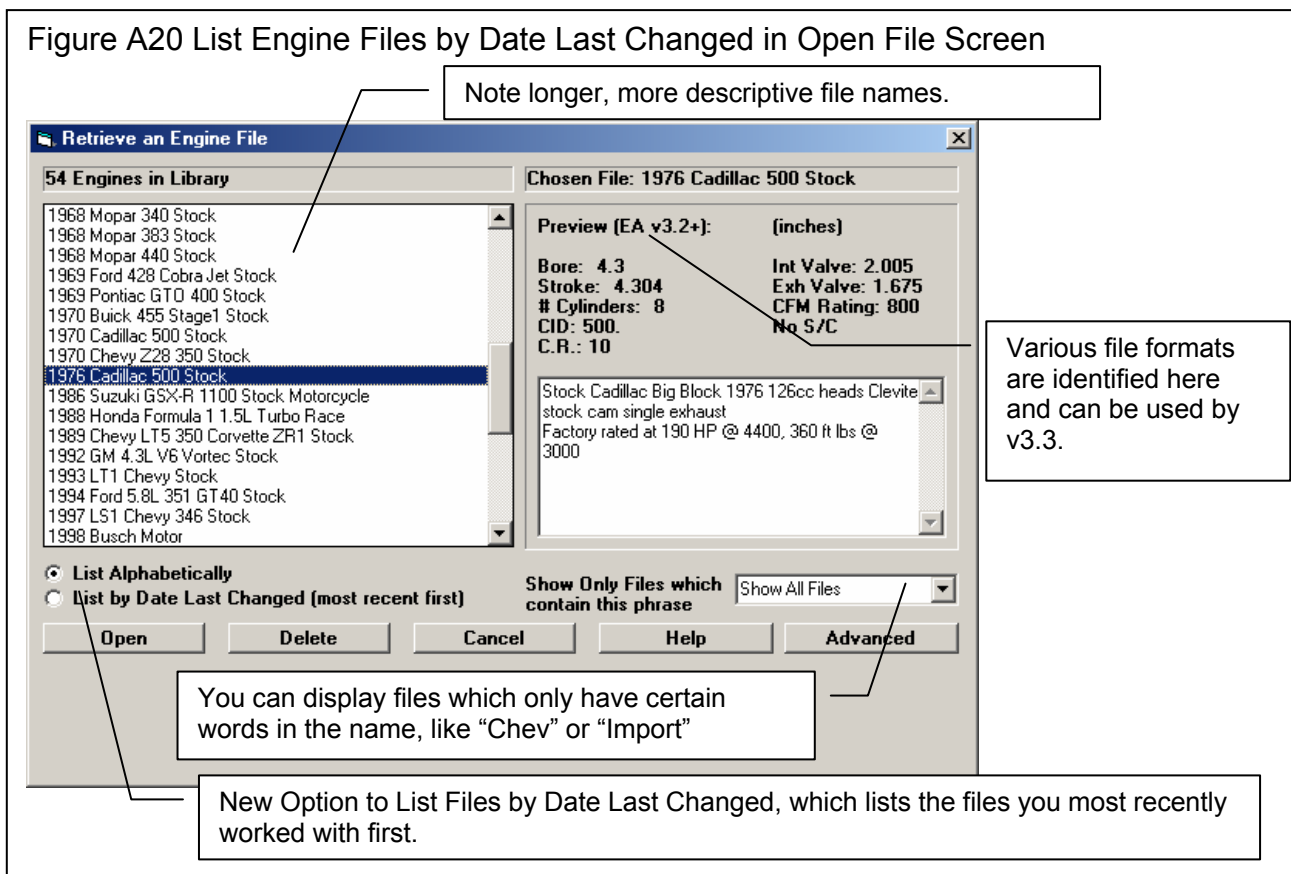
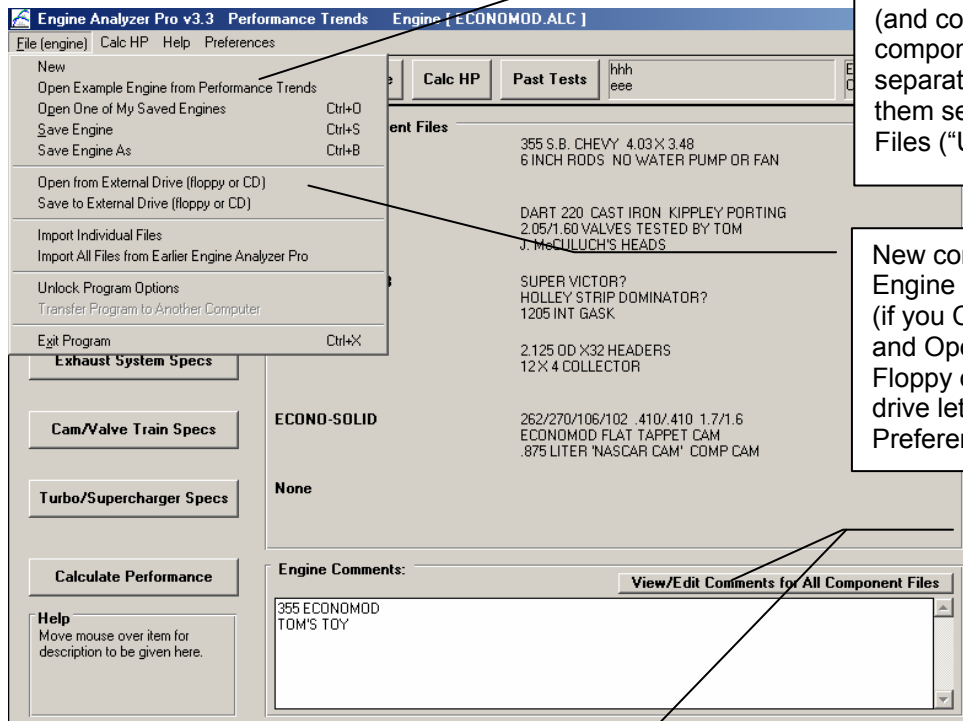

Figure A21 Some New Features on Main Screen



Now the Example Engine Files (and component files in the component screens) are saved to separate "Example" folders to keep them separated from your Saved Files ("User" folders).

New commands let you Save Engine Files to a Floppy or CD drive (if you CD drive is set up for writing), and Open Engine Files from a Floppy or CD drive. The default drive letter can be set in the Preferences menu.

New button to bring up screen to edit comments and names of Total Engine file and all component files shown here.

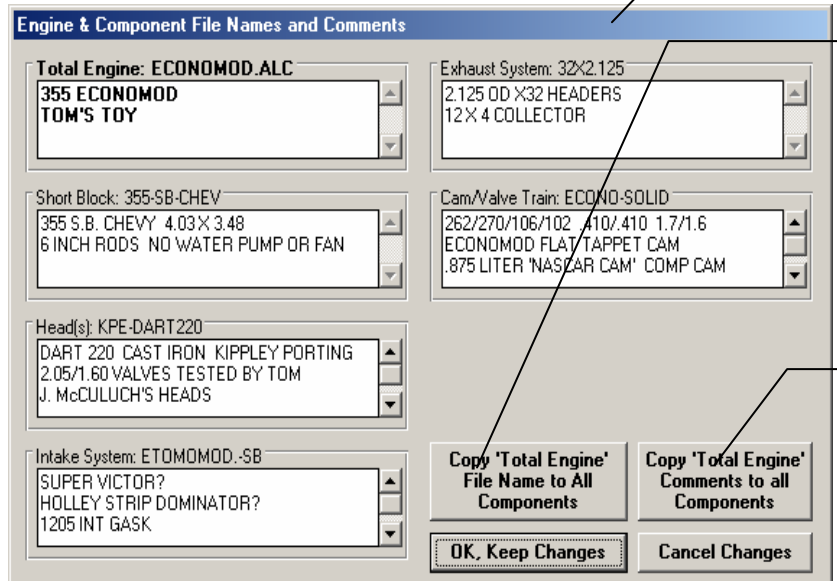

Click here to have the **name** for the Total Engine file (upper left corner) used as the name for each component file name. Note that these component files are NOT saved to their component libraries with these new names at this time. You must go into each component screen and Save them individually.

Click here to have the **comments** for the Total Engine file (upper left corner) used as the comments for each component file name.

Figure A22 Help Options on Main Screen

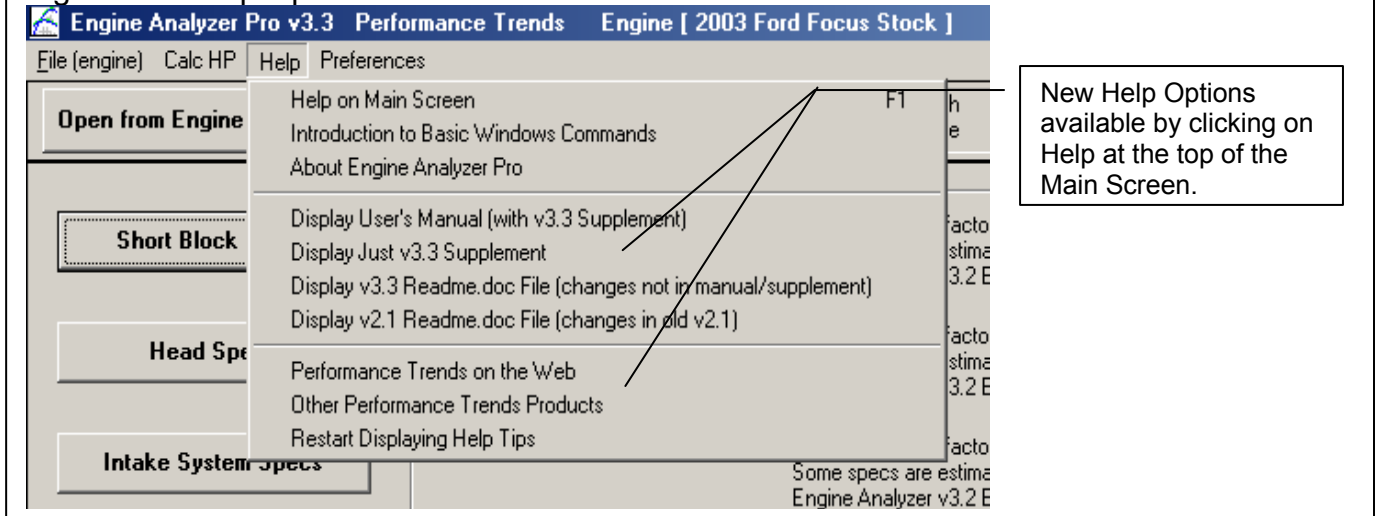

Figure A23 New Items in Short Block Menu

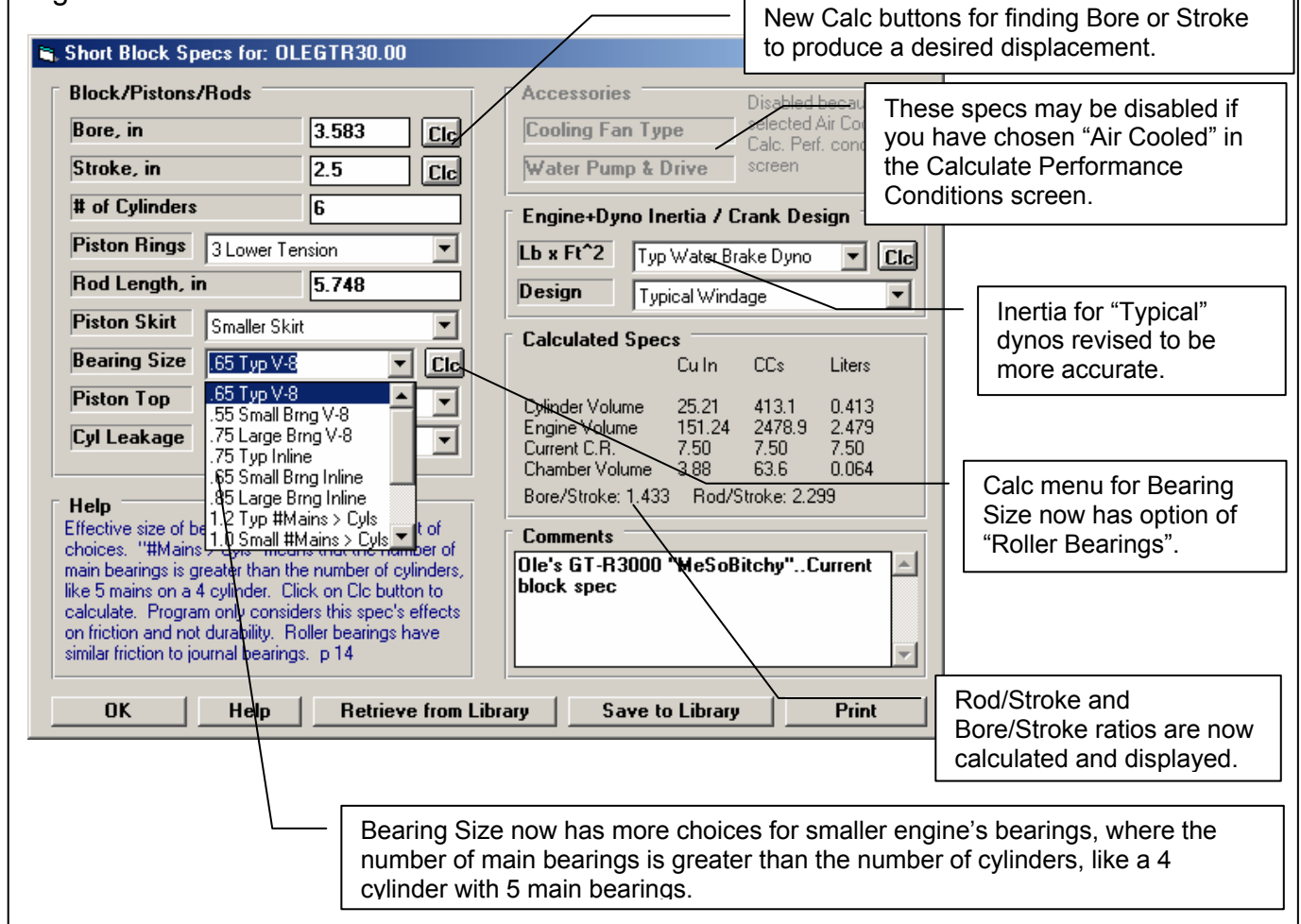
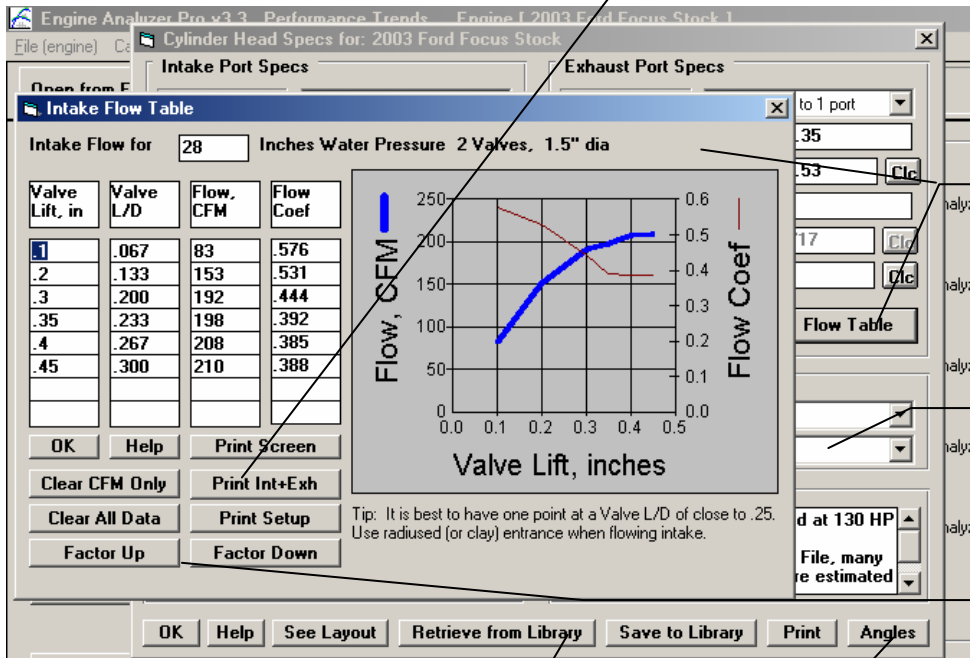

Figure A24 New Features in Head Specs Screen



Several new Print options are available, including "Print Int+Exh" which prints both flow tables to 1 piece of paper.

Click on "Use Flow Table" option (not shown here), then click on Flow Table to bring up the Flow Table screen shown here.

Burn Rating replaces Swirl as an input, and has several more choices for better fine tuning.

Factor Up and Factor Down buttons increase or decrease all flows by a certain percentage that you will be asked to enter.

Click on Retrieve from Library for the options and screens show in the figure on the next page.

Click on Angles button for this screen, where you can enter and save valve angle and other data which is used for the "See-Engine" screen to check piston to valve clearance.,

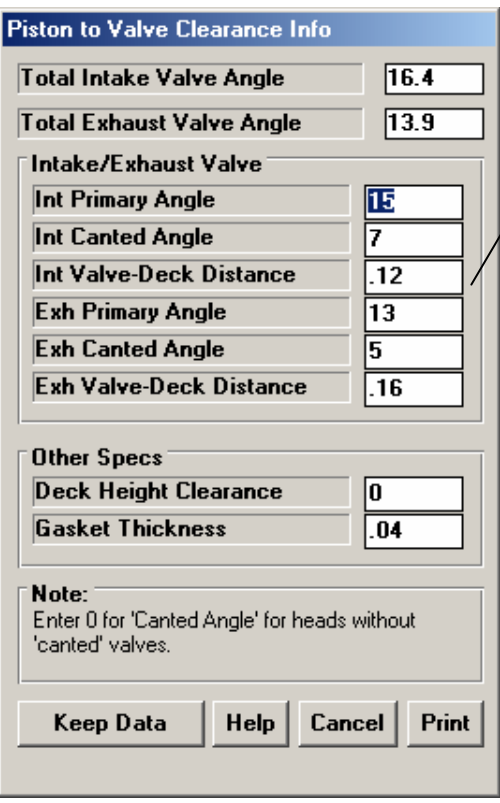

Figure A25 New Features in Head Specs Screen, cont.

Retrieve a Cylinder Head File

338 Cylinder Heads in Library

Chosen File: 1999 Ford Mustang GT 4.6L

Preview (EA Pro v2.1): (inches)

Intake # Valves: 1 Valve Dia: 1.84 Full Flow Table C.R.: 9

Exhaust # Valves: 1 Valve Dia: 1.41 Full Flow Table Mtrl: Aluminum

Production '99 Mustang GT 2 valve.
4.6L Ford Modular Performance
Source: PTI Contact
Chamber CCs:
Intake Port CCs:
Exhaust Port CCs:
Intake Port Dim (gasket):

List Alphabetically
List by Date Last Changed (most recent first)

Show Only Files which contain this phrase: Show All Files

Open Delete Cancel Help Advanced

Std Engine Analyzer Head Examples Load from Port Flow Analyzer

This option loads in simple example specs from our std. Engine Analyzer's Library of Examples.

When you click on the Retrieve from Library button in the Head Specs screen, you can choose either Example Heads from Performance Trends or Heads you have saved. Either will bring up a screen like this.

This section shows Head files saved specifically for Engine Analyzer Pro, with all Engine Analyzer Pro specs entered.

Certain Preferences may have to be turned on or adjusted for these features to be shown or work correctly.

Categories of Cylinder Head Examples for Picking

Categories (groups) of Performance Trends' Examples

- Typ Small 2 Valve Heads
- Typ Small 4 Valve Heads
- Typ Small Flatheads
- Typ Large 2 Valve Heads
- Typ Large 4 Valve Heads
- Typ Large Flatheads
- Small Block Chevrolet
- Big Block Chevrolet
- Mopar (Chrysler)
- Small Block Ford
- Other Ford
- Other Domestic

Categories (groups) of Examples Added by User

New Category Name

Add New Category Name to List

Rename Chosen Category

Delete Chosen Category

See page 118 in manual for details.

Tip: Click on a category in either section to highlight it, then click on the 'Use Category' button, or just Double Click on the category to pick in one step. (Categories are groups of examples, like a group of Chevy heads, not individual examples.)

Open Port Flow Analyzer Test File

31 Tests in Library

Chosen File: CARCUSTO.M

Preview (max CFMs corrected to 10")

Head #:

Intake # Valves:

Valve Dia:

CFM:

1:31 A

40mm EXHA

VW T

Int te

THE

at 10

List All Files by File Name
List by File Name (include Head #)
List by Head # (include File Name)

Open Cancel Help

Tip: Click on a different Folder name to display all the tests saved under that Folder Name

If you own Port Flow Analyzer and have chosen its folder in Preferences, you can pick heads from this screen which is the same as in the Port Flow Analyzer.

Examples

Big Block Chevy HEADS	Layout	Valve Dia	Port Dia	Port CCs	Port Len	Flow Effcy	
AFR BB Chev 305cc Stock	1vlv/1prt	2.25	1.99	306	6	Table	As cast Big Block Chevy PN 3050 Source: 2003 AFR Catalog
(exh)	1vlv/1prt	1.88				Table	Mxln: 364cfm/28" MxEx: 290cfm/28"
AFR BB Chev 315cc CNC Port	1vlv/1prt	2.25	2.02	315	6	Table	CNC Ported '305's Big Block Chevy PN 3150 Source: 2003 AFR Catalog
(exh)	1vlv/1prt	1.88				Table	Mxln: 387cfm/28" MxEx: 315cfm/28"
AFR BB Chev 325cc Stock	1vlv/1prt	2.3	2.05	325	6	Table	As cast Big Block Chevy PN 3250 Source: 2003 AFR Catalog
(exh)	1vlv/1prt	1.88				Table	Mxln: 384cfm/28" MxEx: 290cfm/28"
AFR BB Chev 335cc CNC Port	1vlv/1prt	2.3	2.02	315	6	Table	CNC Ported '325's Big Block Chevy PN 3350 Source: 2003 AFR Catalog
(exh)	1vlv/1prt	1.88				Table	Mxln: 410cfm/28" MxEx: 325cfm/28"
AFR BB Chev 345cc Stock	1vlv/1prt	2.3	2.11	344	6	Table	As Cast Big Block Chevy PN 3450 Source: 2003 AFR Catalog
(exh)	1vlv/1prt	1.88				Table	Mxln: 398cfm/28" MxEx: 290cfm/28"
AFR BB Chev 357cc CNC Port	1vlv/1prt	2.3	2.15	357	6	Table	CNC Ported '345's Big Block Chevy PN 3570 Source: 2003 AFR Catalog
(exh)	1vlv/1prt	1.88				Table	Mxln: 425cfm/28" MxEx: 325cfm/28"

Figure A26 Some New Features in Cam Specs Screen

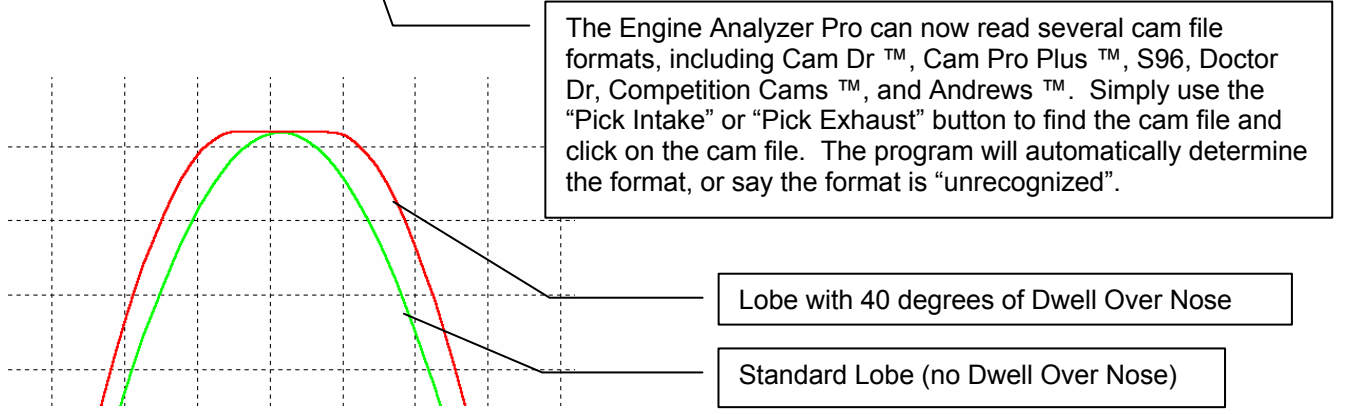

Figure A27 New Features in Calculate Performance Conditions Screen

Calculate Performance Conditions for: 2003 Ford Focus Stock

Test Conditions

Weather: SAE Conds (77 deg, 29.6")

Barometric Pressure, "Hg: 29.9 Clc

Intake Air Temp, deg F: 60

Dew Point, deg F: 32 Clc

Elevation, feet: 0 Clc

Cooling System: Liquid Cooled

Coolant Temp, deg F: 180

Accel Rate, RPM/sec: 0 Steady State

Chassis Dyno Losses: 0

RPMs to Run

Starting RPM: 4000

Number of RPM Steps: 2

RPM Step Size: 500

RPM Preview: 4000, 4500

Fuel Specs

Type: Gasoline

Fuel O: Gasoline, Alcohol, Drag Racing Gasoline, Rich Gasoline, Rich Alcohol, Rich Drag Race Gasoline, Very rich gasoline (for blowers), Very rich alcohol (for blowers)

Spark: Spark Giving Best Power Specs

Do Chain Calculations ?

No See Chain Calculation Specs

Yes

'Starting Point' Recommendations

Tuning Recommendations RPM: 5500

Help

Click on arrow to select type of fuel. Drag Race Gasoline has slightly higher energy content than Gasoline, but has lower vapor pressure (doesn't atomize as well). p 66

OK/Return Help Calculate Performance

Many new fuel choices and fuel richness settings.

Liquid or Air cooling options.

Settings to simulate Chassis Dyno results. These must be turned On in Preferences.

This setting may not be shown if you have turned Off "Recommendations" in Preferences.

Figure A28 New Features in Intake Specs Screen

Intake System Specs for: 2003 Ford Focus Stock

Manifold Specs (1 runner/cyl)

Runner Dia @ Head, in: 1.7 Clc

Design: Straight Runners, merge to head

Runner Length, in: 6.2

Runner Flow Coef: 1.62 Clc

Runner Taper, deg: 0 Clc

Manifold Type: Single Plenum-Racing EFI

Intake Heat: Reduced Heat

Throttle Body(s)

Total CFM Rating: 300 Clc

Secondary Throttles Open @ 4000 RPM

Air Cleaner CFM Rating: 300 Clc

Air Meter CFM Rating: 0 Clc

Restrictor CFM Rating: 0 Clc

Plenum Specs

Estimate Specs Use Specs Below

Plenum Volume, cu in: Clc

New restrictions added. Click the Check Box to enable, then type in a number or click on the Clc button to calculate from various inputs.

New Runner Design input. "Straight Runners, merge to head" enables you to simulate fuel injection runners where the diameter is approximately constant over entire length until it gets close to the head, where it blends into the port in the head. Click on "See Layout" button at bottom of this menu to view Designs.

New Manifold Type choice on "Single Plenum Racing EFI" to simulate racing EFI intakes which look like tunnel rams with electronic injection.

Figure A29 Preference Modifying Output Screen

The screenshot shows the 'Engine Analyzer Pro' interface. At the top, there's a menu bar with options like Back, Graph, Print, Help, File, History, Analyze, See-Engine, and Send. Below the menu bar is a status bar with 'Cmnts' and 'Notes' buttons, and a 'Notes Summary' section. The main area is a data table with columns for various engine parameters and rows for different RPM values (4400, 4800, 5200, 5600, 6000, 6400, 6800, 7200, 7600). Some rows are collapsed. A 'Preferences' dialog box is open on the right, showing the 'General Operation' tab. The 'Choose Data NOT To Display' list includes 'Vol Eff. %', 'Actual CFM', 'Fuel Flow, lb/hr', 'Nitrous, lb/hr', 'Ntrs Fuel, lb/hr', and 'BMEP, PSI'. The 'Allow \'Chassis Dyno Losses\' Factor' is set to 'Yes'.

Engine RPM	4400	4800	5200	5600	6000	6400	6800	7200	7600
Brk Tq, ft lb	472	482	483	471	456	451	408	349	300
Brake HP	396	440	478	502	521	549	528	478	434
Actual CFM	466	524	594	625	639	636	705	672	643
Fuel Flow, lb/hr	170	192	218	229	234	255	258	246	235
A/F Mxtr Qty, %	100.0	100.0	100.0	100.0	100.0	100.0	100.0	100.0	100.0
BSFC, lb/HP-hr	0.431	0.436	0.455	0.456	0.449	0.464	0.489	0.515	0.543
Thermal Eff, %	34.33	34.07	32.78	32.93	33.77	32.94	31.83	31.17	30.58
IMEP, PSI	205	210	211	207	203	202	186	164	146
Frctn Tq, ft lbs	48.29	51.1	53.8	56.7	59.5	62.4	65.3	68.2	71.2
Frctn HP	40.45	46.66	53.3	60.4	68.0	76.0	84.5	93.5	103
FMEP, PSI	19.00	20.09	21.18	22.29	23.41	24.54	25.68	26.84	28.00
Mech Eff, %	90.7	90.4	90.0	89.3	88.5	87.8	86.2	83.6	80.8
Motoring HP	47.34	56.8	71.1	78.9	84.4	101	130	152	173
Pumping Work, HP	-6.88	-10.16	-17.82	-18.50	-16.42	-24.62	-45.50	-58.3	-69.9
Residual Exh, %	8.1	3.7	1.6	1.7	2.4	1.6	1.9	3.2	5.8
Shrt Circuit, %	0.0	0.9	3.0	2.3	0.7	1.6	1.5	0.7	0.1
Exh Temp, deg F	1373	1398	1415	1396	1371	1330	1354	1409	1463
Mx Cyl Pres, PSI	1060	1067	1078	1057	1024	1032	986	892	818
Mx Cyl Temp, deg F	4477	4617	4673	4660	4620	4660	4648	4576	4470
In Port Temp, deg F	84	77	73	73	73	69	64	67	75
Piston Spd, ft/min	2567	2800	3033	3267	3500	3733	3967	4200	4433
Piston Gs @ TDC	1230	1460	1720	1990	2290	2600	2940	3300	3670
Coolant HP	192	214	231	246	260	278	305	323	341
Blow By, CFM	0.0	0.0	0.0	0.0	0.0	0.0	0.0	0.0	0.0

Value Flow & Cam Calculations		--Int--		--Exh--	
Overlap Area, deg*sq-in	31.9	Ulv Area, deg*sq-in	437.4	Ulv Area, deg*sq-in	338.5
Total Exh/Int %	77.4	Total Avg Flow Coef	0.381	Total Avg Flow Coef	0.513
Lobe Separation, deg	106.0	Lobe Area, inch*deg	32.55	Lobe Area, inch*deg	32.93
Overlap, deg	106	Duration, deg	315	Duration, deg	319
Overlap @ .050, deg	48	Opening Events, deg	56	Opening Events, deg	90
		Closing Events, deg	70	Closing Events, deg	50
		Duration @.050, deg	258	Duration @.050, deg	262
		Opp Events @.050, deg	27	Opp Events @.050, deg	61
		Cls Events @.050, deg	51	Cls Events @.050, deg	21
		Lobe CenterIns, deg	102.0	Lobe CenterIns, deg	110.0

Note that certain rows of output are "collapsed" and not shown. These rows have been picked in the Preferences menu as shown below.

The 'Preferences' dialog box is shown with the 'General Operation' tab selected. It contains several sections: 'Auto-Link to Vehicle Program' with a dropdown menu set to 'None, Don't Auto-Link to Any Program' and a 'Find' button; 'Send Power Curve to Vehicle Program' with a dropdown menu set to 'Allow a Choice Each Time'; 'Choose Data NOT To Display' with a list box containing 'Vol Eff. %', 'Actual CFM', 'Fuel Flow, lb/hr', 'Nitrous, lb/hr', 'Ntrs Fuel, lb/hr', and 'BMEP, PSI'; and 'Allow \'Chassis Dyno Losses\' Factor' with a 'Yes' button. On the right side of the dialog, there are buttons for 'OK', 'Cancel', 'Restart Showing Help Tips', 'Turn Off Showing Help Tips', 'Help', and 'Don't Ask About Updating'.

Settings under "General Operation" also let you size and customize the "Special Calculations" section.

New outputs for Duration at .200" lift and lift at TDC

Figure A30 New Features for the "See Engine" Screen

Click on "Options" to bring up the Options screen shown here.

Valves for 4 valve and hemi engines now drawn coming from opposite sides of chamber.

Program now lets you enter a secondary valve angle for "canted" valve engines like hemis. These angles are also saved in the Head Specs screen. Click on the "Angles" button to view.

See Engine' Options

Emphasize
 Intake Valve Exhaust Valve
 Intake and Exhaust Valve Equally

Thickness of Selected Lines
 Thin Lines Thick Lines (sh)

RPM to See (analyze)

Data To Graph

Typical Dimensions of Common Heads

OK Cancel Tabular

Note: This screen is not a substitute for checking clearances with clay! Clearances are based on a flat top piston and NO rod stretch. [Some dimensions not to scale. Click on Help button for more information.]

Click the Tabular Data button for some critical data to be listed in columns in Notepad. From here you can print it, save it to a file or copy and paste it into a spreadsheet program

RPM =	Crank Deg	Piston Depth	Int Lift	Exh Lift	Int PSI	Exh PSI	Cy1 Temp	Cy1 PSI
4500	112	2.609	.000	.001	16.1	16.3	2466	88.7
	116	2.705	.000	.002	16.1	15.9	2414	84.2
	120	2.796	.000	.005	16.0	15.7	2366	80.2
	124	2.882	.000	.010	15.7	15.6	2328	77.2
	128	2.962	.000	.016	15.2	16.4	2279	73.6
	132	3.036	.000	.024	14.7	17.7	2228	70.2
	136	3.104	.000	.033	14.1	19.0	2177	66.8
	140	3.167	.000	.044	13.6	20.7	2127	63.5
	144	3.223	.000	.057	13.2	22.7	2070	59.8
	148	3.274	.000	.071	12.8	24.5	2015	56.2
	152	3.318	.000	.086	12.6	26.2	1959	52.7
	156	3.357	.000	.103	12.5	27.5	1905	49.4
	160	3.390	.000	.119	12.5	28.6	1850	46.1
	164	3.417	.000	.137	12.6	29.5	1788	42.6
	168	3.438	.000	.154	12.8	29.9	1736	39.7
	172	3.453	.000	.171	13.1	29.7	1687	37.1
	176	3.462	.000	.188	13.5	29.1	1634	34.4
	180	3.465	.000	.205	14.0	28.2	1590	32.3
	184	3.462	.000	.220	14.4	26.8	1546	30.3
	188	3.453	.000	.236	14.8	25.1	1500	28.5
	192	3.438	.000	.250	15.0	23.6	1460	26.9
	196	3.417	.000	.263	15.2	22.0	1413	25.2
	200	3.390	.000	.276	15.4	20.5	1366	23.5
	204	3.357	.000	.288	15.4	19.3	1326	22.2
	208	3.318	.000	.299	15.2	18.0	1280	20.7
	212	3.274	.000	.308	15.0	17.0	1242	19.5
	216	3.223	.000	.317	14.7	16.1	1204	18.4

Figure A31 Some New Graph Features

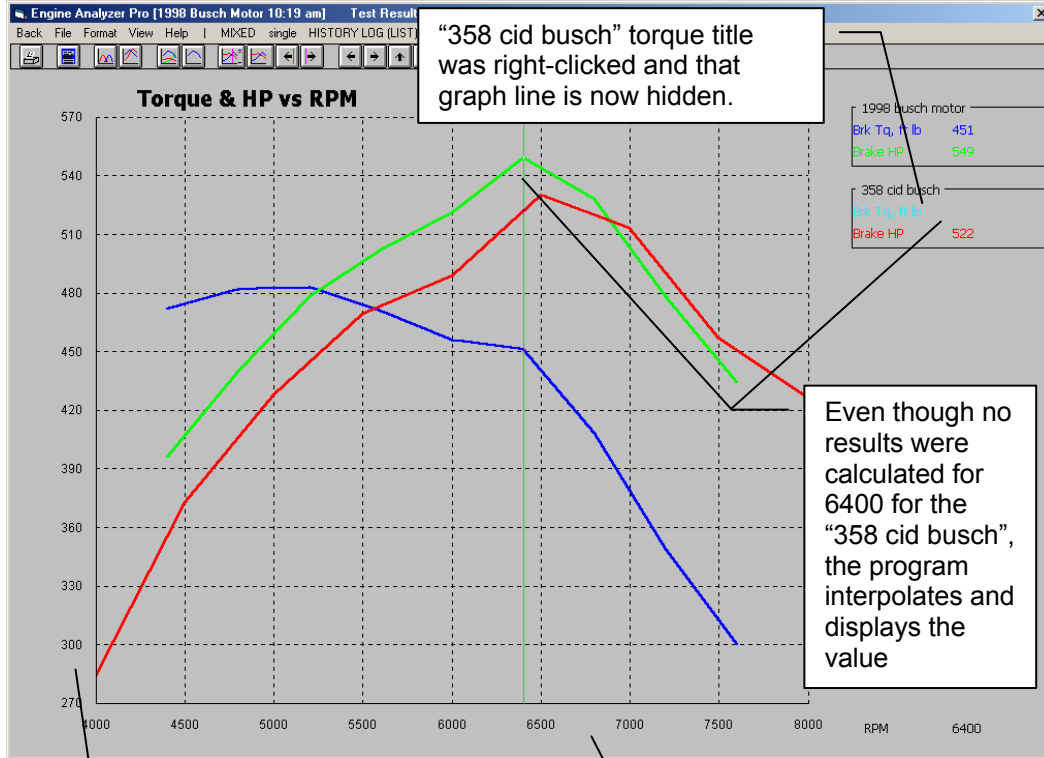

For Cycle Data graphs, the cursor location now includes location before or after TDC or BDC.

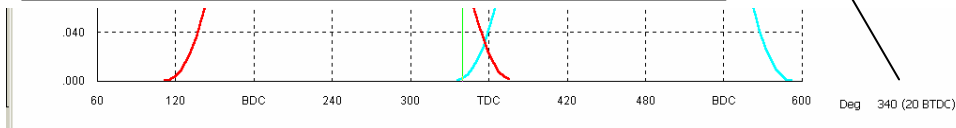

New commands for saving scale settings

Click here for Set Scales screen

The screenshot shows the 'Graph Scales' dialog box. It has tabs for 'RPM Data', 'Cycle Data: Degrees', 'Cycle Data: Cyl Vol', and 'Cycle Data: Time'. The 'RPM Data' tab is active, showing fields for Max RPM (6000), Min RPM (2000), Max Recorded (Y) Data (200), and Min Recorded (Y) Data (100). There are radio buttons for 'AutoScaling ON (computer picks scales)' and 'AutoScaling OFF (use specs given above)'. A callout box points to the 'Set Scales' button in the menu bar, stating: Click here for Set Scales screen. Another callout box points to the 'Open Saved Settings' button, stating: Screen obtained by clicking on Open Saved Settings. A third callout box points to the 'AutoScaling OFF' radio button, stating: AutoScaling must be Off for these settings to be used.

Figure A32 Auto-Linking to a Vehicle Program (Drag Racing Analyzer v3.2 shown here)

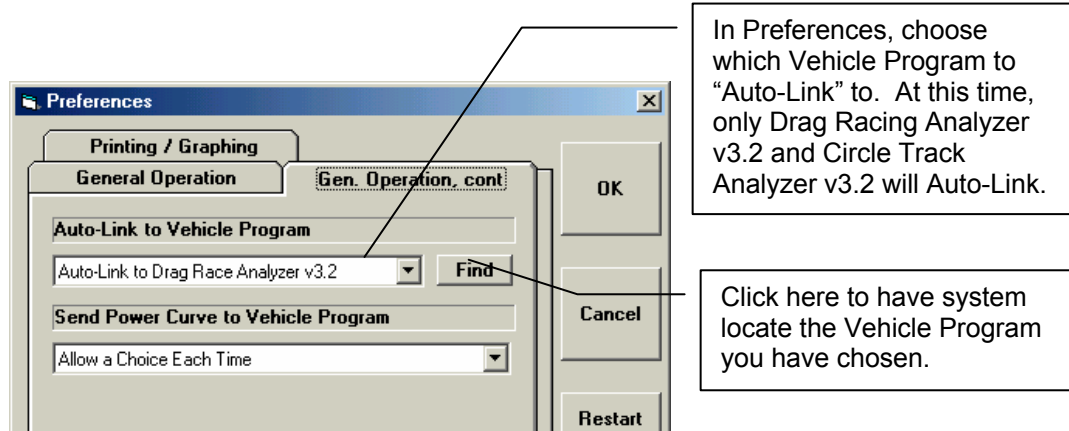

The results of the New (current) Engine Power Curve coupled with the Vehicle File in the Vehicle Program produces these results. The "Last" results are for the previous Engine Power Curve coupled with the same vehicle.

Click on these results to get a summary of the New vehicle results as shown here.

	0.0	0.5	0.8	1.0	1.5	1.75	1.8
Vol Eff %	147.6	148.8	149.8	150.4	149.8	148.1	144.
Actual CFM	391	446	501	555	605	649	683
Fuel Flow	136	155	174	193	210	225	237
A/F Mix Qal	100.0	100.0	100.0	100.0	100.0	100.0	100.
BSFC	.662	.648	.636	.628	.626	.620	.623
BSAC	8.377	8.197	8.048	7.940	7.922	7.837	7.87
Friction HP	65	77	91	105	120	136	151
Mach #	.211	.239	.267	.296	.324	.352	.380
Piston Snd	1772	2008	2244	2480	2716	2953	3189

ton	Pk Tq	Avg	Pk HP	Avg	DRR	ET	Imprv
New	384	358	393	323	New	11.43	.18
Last	365	342	384	310	Last	11.61	

EA Summary of Results from Vehicle Program:

ET: 11.43
 MPH: 114.92
 60 ft: 1.58
 Density Altitude: 155
 Dry Density Altitude: 271
 Distance: 1320
 Vehicle Weight: 3150
 Trans Gear at Finish: 3
 Automatic Transmission
 File: New DRR Link Try
 Errors: None reported.

You do not need to start the vehicle program; the Engine Analyze Pro will do it automatically. The vehicle file being used is the last vehicle you were working with when you shut down the vehicle program (the vehicle that would be opened when you start the vehicle program).

A 2-3 second time delay is built in the Engine Analyzer Pro to ensure reliable communications when doing Auto-Link. You will not be able to click on Back to return to the Main Screen before this delay is over. You may also notice the progress bar from the Vehicle Program momentarily appear on the screen, indicating the vehicle program is running.

History Log

The original Engine Analyzer Pro v2.1 had a method of letting you save important test results for analysis and comparisons in the future in a “Common List”, a list of commonly used test results files. This was done by clicking on File” at the top of the test results screen. Read Section 3.6, page 147 for more information on using this powerful, but somewhat less convenient method of saving test results.

The Engine Analyzer Pro remembers the results and the engine specs which produced those results for up to the last 25 to 100 runs you have made. The number of runs saved is selectable in the Preferences menu. This can be a very handy comparison of one run to another and saves you the trouble of making notes on pieces of paper. It is also handy to be able to go back to some condition which gave very good performance, but you don’t remember why or what the specs were. Figure A33 shows the History Log and options.

This History Log is also the method used to determine which test results will be graphed. You have 3 choices for picking results to graph:

1. Current Run only
2. Current Run plus the “Last” run (where the Last run is the run made immediately before the Current Run)
3. Current Run plus runs picked from the History Log (or “Common List” if you have chosen to “Use Old v2.1’s ‘Common List’ as Method of Picking Which Saved Runs to Graph”, Section 3.6, page 147)

Figure A33 History Log and Options

Click on File to save test results using the older method described in Section 3.6, page 147. This can be more powerful, but less convenient than the History Log.

Click on History for History Log Options discussed in this section.

Click on Test Title to retrieve the specs which produced these results.

History Log is displayed below the columns of test results.

Click and move slide bar to display all 25 to 100 runs in the History Log.

Engine RPM	4000	4500	5000	5500	6000	6500	7000	7500	8000
Brk Tq, ft lb	373	436	450	448	428	428	385	320	280
Brake HP	284	373	428	469	489	530	513	457	426
Actual CFM	339	441	517	586	599	671	692	649	631
Fuel Flow, lb/hr	124	161	189	215	219	246	253	237	231
Nitrous, lb/hr	0.00	0.00	0.00	0.00	0.00	0.00	0.00	0.00	0.00
Ntrs Fuel, lb/hr	0.00	0.00	0.00	0.00	0.00	0.00	0.00	0.00	0.00
BMEP, PSI	158	185	190	190	181	181	163	136	119
A/F Mxtr Qlty, %	100.0	100.0	100.0	100.0	100.0	100.0	100.0	100.0	100.0
BSFC, lb/HP-hr	0.438	0.432	0.442	0.457	0.448	0.464	0.494	0.520	0.542
Thermal Eff, %	34.03	34.18	33.52	32.64	33.67	32.77	31.42	30.95	30.67
IMEP, PSI	175	203	211	211	204	205	188	163	147
Frotn Tq, ft-lbs	41.08	44.20	47.35	50.5	53.7	57.0	60.3	63.6	67.0
Frotn HP	31.29	37.87	45.07	52.9	61.4	70.5	80.4	90.9	102
FMEP, PSI	17.40	18.72	20.06	21.41	22.77	24.15	25.54	26.96	28.39

Test Title	Graph?	Graph Title	Save?	Peak Tq	Incr.	Avg Tq	Incr.	Peak HP	Incr.	Avg HP	Incr.	CycRP
1998 Busch Motor: Wed Mar 24 04 10:19 am		1998 Busch Motor 10:19		450 at 5000	439.9	394	385.51	530 at 6500	522.32	441	434.00	5000
BRIGGS: Tue Mar 23 04 12:25 pm		BRIGGS 12:25 pm		10.1 at 3500	26	8.49	.13	7.68 at 4500	.11	7.00	.11	3500
BRIGGS: Tue Mar 23 04 12:24 pm		BRIGGS 12:24 pm		9.90 at 3500	-170.10	8.36	-170.64	7.57 at 4500	-146.43	6.89	-138.11	3500
lv2.1 ALFA-ROM.-V6: Tue Mar 23 04 12:21 pm	Yes	new fins 250		180 at 4500	-14	179	-12	154 at 4500	-12	145	-9	4500
lv2.1 ALFA-ROM.-V6: Tue Mar 23 04 12:20 pm	Yes	new fan 250		194 at 4500	10194.00	191	18	166 at 4500	10166.00	154	14	4500
lv2.1 ALFA-ROM.-V6: Tue Mar 23 04 11:42 am		lv2.1 ALFA-ROM.-V6		-10000.00 at 0	-10174.0	173	0	-10000.00 at 0	-10148.0	140	0	0
lv2.1 ALFA-ROM.-V6: Tue Mar 23 04 11:39 am	Yes	fins 250		174 at 4000	-19	173	-18	148 at 4500	-18	140	-15	4000
lv2.1 ALFA-ROM.-V6: Tue Mar 23 04 11:38 am	Yes	fan 250		193 at 4500	-12	191	-8	166 at 4500	-10	155	-7	4500
lv2.1 ALFA-ROM.-V6: Tue Mar 23 04 11:37 am	Yes	liq 165		205 at 4500	27	199	21	176 at 4500	24	162	18	4500
lv2.1 ALFA-ROM.-V6: Tue Mar 23 04 11:36 am	Yes	fins 165		178 at 4000	-19	178	-17	152 at 4500	-17	144	-14	4000
lv2.1 ALFA-ROM.-V6: Tue Mar 23 04 10:11 am		lv2.1 ALFA-ROM.-V6		197 at 4500	1	195	3	169 at 4500	1	158	2	4500
lv2.1 ALFA-ROM.-V6: Tue Mar 23 04 10:10 am		lv2.1 ALFA-ROM.-V6		196 at 4500	23	192	20	168 at 4500	22	156	17	4500
lv2.1 ALFA-ROM.-V6: Tue Mar 23 04 10:09 am		lv2.1 ALFA-ROM.-V6		173 at 4000	-210	172	-155	146 at 4500	-185	139	-142	4000
302400LI.FT: Sat Mar 13 04 9:35 am		Crane 444211 +5		383 at 4000	13	327	11	331 at 5200	14	281	12	4000
302400LI.FT: Sat Mar 13 04 9:31 am		Stock +4		370 at 4000	-4	316	-3	317 at 5200	-10	269	12	4000

Click on Test Title (1st column) to change it or to retrieve specs which produced those results. Click in other columns for definitions.

This section discusses the use of the new History Log, and how it can be used to do analysis, retrieve past results and engine specs, and choose saved test results for graphing.

Test Title

Click on Test Title and you are asked if you want to retrieve the specs which produced these results. The program will first ask if you want these specs retrieve, answer Yes and the specs are retrieved.

Graph?

You can choose what Test Results to graph by clicking on the Graph column to insert a Yes there. Clicking on a Yes will blank it out (remove the Yes). Tests marked Yes to Graph will be graphed when you click on the 'Graph Tests Marked 'Yes' '. The first test (usually the current Test you are working with) is always graphed even with no Yes marked. The number of tests actually graphed are limited by available space, usually a limit of about 24 graph lines total. The tests marked in the History Log are only graphed if you have clicked on "history log (list)" at the top of the Graph Screen.

Graph Title

Graph Title is the name which will be printed on graphs for this run. The default Graph Title is the engine file's name. Click on Graph Title and you can change the name to most anything you want, 16 characters maximum. This is a useful place to put what this test is, like "Crane 256 Cam", or "Baseline".

Save

Choose to Save certain Test Results by clicking on the Save column to insert a Yes there. Tests marked Yes to Save move to the bottom of the History Log as more runs are made, but will not fall off the History Log.

Pk Tq/Incr, Avg Tq/Incr, Pk HP/Incr, Avg HP/Incr

Are the Peak Torque, Average Torque, Peak HP and Average HP test results for the particular run. The "Incr" results are the increase of a particular run over the previous run.

Print

You can print the History Log on a printer by clicking on the 'Print' menu command. Note that the History Log will be most readable when the Page Orientation is in Landscape setting.

History Log at Graph Screen

At the Graph Screen, several options are available to graph selected tests from the History Log, and change the Graph Titles. You can obtain the History Log by clicking on the menu command History Log at the top of the Graph Screen. The History Log is how you graph different tests together for comparison. From this screen you can:

- Choose to Graph certain Test Results by clicking on the Graph column to insert a Yes there. Tests marked Yes to Graph will be graphed when you click on the 'Graph Tests Marked 'Yes' '. The first test (usually the current Test you are working with) is always graphed even with no Yes marked. The number of tests actually graphed are limited by available space, usually a limit of about 24 graph lines total.
- Graph only the current test results (the test file at the top of the Log) by clicking on 'Graph Current Test Only'.
- Click on 'Graph Title' to change the Standard Title for this test. The program defaults to the Engine File Name, but you can change this to most any name of 24 characters or less. You can also specify 'Alternate' titles and legend names by clicking on 'Format' at the top of the Graph Screen, then 'Edit Titles/Legends'.

Important: The History Log is only used as described here for picking which test results to graph in you have set “Use Old v2.1’s ‘Common List’ as Method of Picking Which Saved Runs to Graph” to No in the Preferences menu.

Figure A34 History Log at Graph Screen

Click on the History Log button or Menu Command to display History Log.

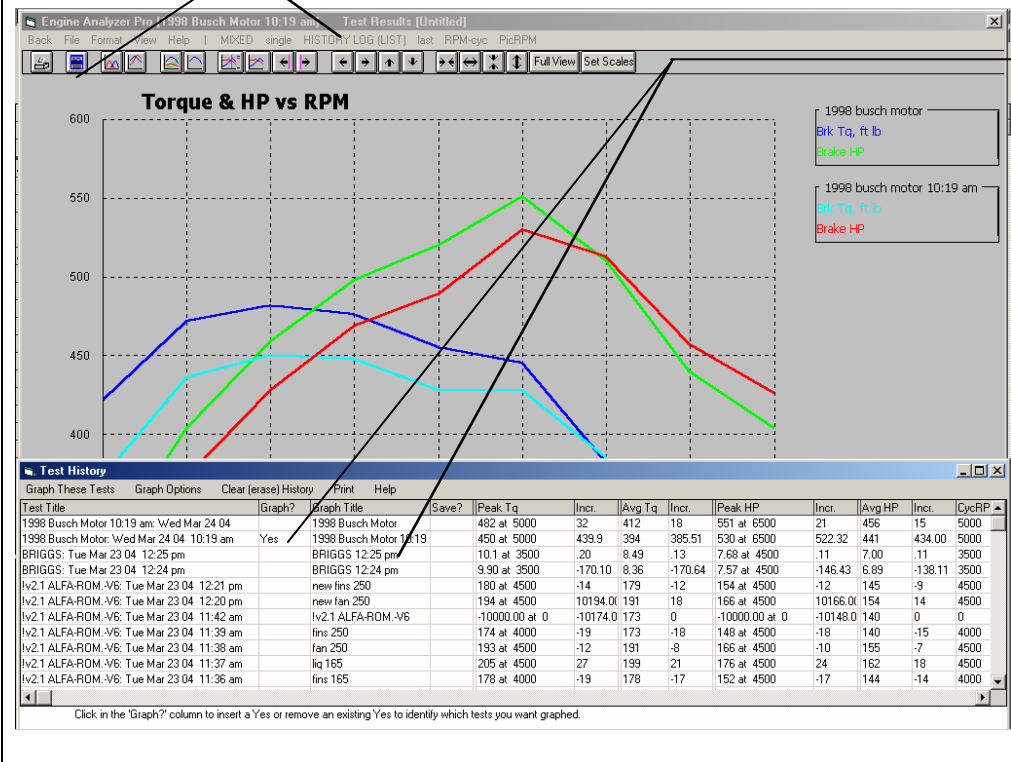

From the Graph Screen, these columns are used for determining which results are graphed:

1. Click in the Graph? column to add a Yes or remove a Yes. Tests marked Yes to graph are graphed if you select Graph Tests Marked 'Yes'.
2. Click in the Std Graph Title column to change the Std Graph Title. Alternate titles are also possible by clicking on Format, then Edit Legend/Titles.

Appendix 10: New Features in v 3.5

Engine Analyzer Pro has had many updates since this user manual was written for the original v2.1 for Windows. These include v2.1 B, v2.1C, v2.1D v3.3 and now v3.5. Here is a brief listing of some of the features new since v3.3 was released, including Version 3.5:

New Features:

- The “Chain Calculation” feature to automatically set up several calculations with various settings has been extensively expanded. Previous to v3.5, you could only set 1 or 2 engine specs to change between calculations. Now you can set up to 6 different engine specs to change, allowing you to make thousands of calculations without requiring any action from you. Since thousands of calculations require lots of time (hours or days), an estimate of the required time is displayed before you start the calculations. Also, because thousands of calculations would require lots of evaluation time, settings are available to only keep combinations and results which meet your requirements. See Fig . There is also a new Preference you can set to keep the best 5 to 35 results, under the General Operation tab called “Chain Results to Display”. However, all results are kept, and if you change the requirements, the 5 to 35 results for the new criteria will be displayed.
- The Engine Analyzer Pro will now Auto-Link to the Fuel Economy Calculator, and let you send power curves to both Fuel Economy and Trans Gear Plus Calculator programs.
- In the See Engine screen (to watch the piston interact with the valves, flows and pressures) an Viewing Speed option has been added. Also, the graph at the top of the "See Engine" screen now will adjust its scales if the results go off scale, unless you've asked for "detailed" graphs, where then the scales are adjusted to zoom in on certain results.
- A new Graph command to show the line labels (Legend Titles) in larger text has been added. Click on Format, then Legends (graph line labels), then you have 3 choices. Classic is old way, Larger and Largest show the text in larger fonts for easier reading, and let you scroll up and down to show all of them.
- Several options and features for emailing files has been added. At the main screen, you can click on File, and then Email an Engine File. Also, once you have calculated results, you can click on Print, then Print Test Results, and check the “Email as PDF™ file”. This allows you to email an Adobe Acrobat printout of the report to any email address. You must have Adobe Distiller as a printer option to do this, only available if you own the full Adobe Acrobat.
- The Preferences menu now has a new Tab called Emailing, where settings for these new email options are stored. If you are using Outlook, Outlook Express or Eudora, all you need to do is choose one of them. If you choose “Other-use specs below”, you will have to fill in the required fields:
 - IP address can be obtained by clicking on the Find button.
 - SMTP server must be obtained from the settings in your email program.
 - Sender Email Address lets you specify the email address that the recipient of the email can reply back to.
 - Note: In Eudora, to eliminate a MAPI warning, click on tools, options, MAPI, shut off the automatic warning of MAPI.
 - In Preferences, under the General Operation tab, options for having the computer “beep” when calculations are done have been added
- You can right click in the list of Std Engine Analyzer Example Cams and the Valve Lift (tappet lift x rocker arm ratio) is displayed.
- The program now makes metric to English and vice versa conversions of the head angle and clearance dimensions, part of the Head Specs.
- Click on File at the top of the main screen, and either Backup or Restore to backup or restore some or all data files with only a couple of key strokes. This makes it much easier to backup and restore files, and transfer the program from one computer to another.
- In the Head, Intake and Exhaust screens, there is a button to “Show Layout”, a drawing of the intake and exhaust runners and valves. Version 3.5 now more accurately resizes these drawings if you resize this screen, and shows the labels in Inches or MM.
- The program now shows pictures of typical Manifold Types in Intake Specs screen to better clarify what is meant by the various types.
- A Calculation Menu (Clc button) option for Intercooler Restriction based on intercooler dimensions has been added. Also, if you calculate Intercooler Restriction from dimensions, an optimistic estimate of Intercooler Effectiveness is also calculated, which you can use if you choose to.
- A new Preference to have program remember the last type of graph you were making when you restart the program has been added. It is under the Printing/Graphing tab and is called 'Always Remember Last Graph Setup'.

- The program now remembers any 'search phrase' you were using in the various "Open" screens for the engine and component libraries. It also now has a 'Show All Files' button to simply restore all files to the list.
- The program now warns if the intake or exhaust lobe max lift is zero, typically caused from a problem in a cam profile file.
- The program now asks to save changes to the engine file you are working on (to the permanent copy in the Engine Library) when quitting the program.
- The program no longer checks for valid cam specs that are not needed, like if you are using a Cam File.
- Program now has some enhancements in the Preview when opening Metric files.
- Now if you click on Cancel at point where program asks for a Report Comment, you will cancel printing also, in addition to canceling just entering a comment.
- An 'Open from Cam Analyzer' button in the Retrieve form for Cam/Valve Train screen has been added. It explains how to go about using a Cam Dr file.
- A Preference to 'Choose Data NOT to Display' in the Test Results screen has been added.
- A Preference to allow NOT printing the Special Calculations section has been added.
- A more detailed help for Valve Angles, Comp Ratio calculation menus and History Log has been added.

New Inputs:

- Added new Cam Profile Option of Specified Ramp which would then enable Ramp Rating, a rating from 0-100% with 100% being the most aggressive ramp. There is also now a new 'Clc' button for Ramp Rating to determine which rating best matches your profile specs.
- Added 4 more input lifts for the flow table, so it now has 12 total. Added a check for unusual flow coefficients (less than .3 or greater than .9) when leaving the Flow Table, and program asks if you want to keep current entries.
- A new Turbo Input of "Maximum Flow, CFM", has been added. It is estimated on a compressor map as the point on the right side of the map where the efficiency has dropped to 40% at a pressure ratio (PR) of 2. The program assumes that flows much higher than this will produce very poor efficiency and the turbo has met its flow limit.
- A new Turbo Input of "Wastegate Is..." has been added, so boost can be controlled to either the pressure Before or After the Intercooler.
- Increased the Turbo A/R ratio allowed in the Calculation Menu.
- Added both Single and Dual Ball Bearing Types to the Turbo Exhaust Turbine Efficiency choices.
- Many more choices for Turbo Exhaust Turbine Efficiency have been added, 55, 65, 70, 80 and 90%. It was previously 55, 70 and 80%
- The "Throttle Location" in the Roots Supercharger specs was changed to 'Type', a combination of Throttle Location and Basic design. The Design choices are Standard (like in prior versions of EA Pro) and a new "Modern" design, new for v3.5. The Modern Choice assumes that tight seals do not increase the friction as much as prior versions and that the volumetric efficiency is slightly better also.
- A 'Use MM Inputs' in the Calc Menu for Carb/Throttle Body CFM Rating when using Inches for measurement inputs has been added. Most throttle bodies, even in the US are measured in mm.
- An additional method of calculating Rocker Arm Stiffness for Valve Train Dynamics has been. It is based on the amount of 'Lost Lift' of the valve because of the valve spring force at max valve lift.
- The program now allows collector exits to be as small as 60% of the Exh Runner Diameter.
- The program now allows for negative taper angles on the Detailed Exh Collector.
- The program now allows for slowing down the burn rate by up to 50%. Previously, the program only allowed for speeding up the burn rate.
- The minimum Eff Rocker Arm Stiffness has been dropped down to 1000. Some small engines do have numbers this low.
- The minimum dimension required for some critical specs has been lowered so VERY small engines can be simulated.
- The Air Meter and Intake Racing Venturi Restrictor inputs, and their calculation menus, have been finalized and updated.
- An Air Cleaner restriction CFM can now be calculated from Flow Data.

New Outputs:

- As discussed above, the Chain Calculation allows for many new types of output, including average and peak torque and HP.
- A 'Spring Table' option to the Valve Train Dynamics screen has been added. It allows you to print out tables of spring force at various lifts, with option for forces as seated height and valve open height also.
- Several features to deal with Valve "Clash" for Hemi and 4 Valve heads in the See-Engine screen (which also evaluates piston-to-valve clearance) have been added. Clash occurs when a valve enters into the valve 'curtain area' of the other valve, for example if the intake enters into the 'curtain area' of the exhaust valve during overlap.
- A new Preference for Desired 'Clash' clearance has been added. If Clash is less than this amount, the Clash value is displayed in Red in the See-Engine screen.
- An option has been added to the See-Engine screen, to print tabular data for piston clearance, piston position, pressures, valve opening, and new 'Clash' in either 1 or 4 degree increments. This option can be accessed by either clicking on the Options at the top of the See Engine screen, then clicking on the Tabular Data buttons, or clicking on Print, then one of the Print Options.
- A Preference to graph either Carb Metering Signal or Heat Release has been added.
- The turbo output for Pressure Ratio to better describe the ratio across the compressor by itself has been refined. Previously, the PR more closely equaled the PR across the compressor and intercooler together.

Accuracy Improvements:

The new inputs discussed above have allowed for improved accuracy. In addition to these changes, the calculations themselves have been refined for better accuracy. These include the following:

- Several refinements to the exhaust tuning for better accuracy have been made. This includes how the flows and pressure waves change at the junctions and steps, and how the runner and collector is divided up into sections for calculations. . In general, these more accurate exhaust tuning features tend to show slightly more performance than found in v3.3. Highly tuned engines show more improvement in v3.5 than stock engines, which show almost no difference. These improvements make the "Detailed Collector" option more accurate than in previous versions.
- There is a Preference to have the program estimate either valve toss or hydraulic lifter pump up even with Valve Train Dynamics turned Off. In v3.3, the program could be showing a power loss, but not be showing valve toss or hydraulic lifter pump up. In v3.5, if there is a power loss from valve toss or hydraulic lifter pump up, the program also shows that valve toss or hydraulic lifter pump up are present.
- The program now increases the stiffness at the cam/lifter stiffness for rocker arm OHC and direct acting OHC valve trains.
- The program has several refinements for estimating valve train friction, valve toss or hydraulic lifter pump up, and exhaust tuning when using mm measurements.
- The seat timing events in the Special Calculations section when using .000" as the event are more accurate because program previously used .0005" as the cut off point, not .000".
- The Turbo Nozzle Area is now being estimated more accurately when specifying twin turbos.
- The program now estimates the effect of intake boost pressure and/or exhaust back pressure on valve opening forces and dynamics more accurately. The program now also shows warnings in the results and the Valve Train Dynamics input screen if these pressure forces are significant compared to valve seated force.

Figure A35 New Chain Calculation Features

Chain Calculation Specs for: Iv2.1 98-WNSTN.CUP

Chain Spec #1
 Spec Type and Name: Intake Port Diameter (2 2)
 Starting Spec Value: 1.8
 # Chain: 4 Chain Step: 2
 Preview: Intake Port Diameter 1.8, 2, 2.2, 2.4
 Current Value: 2.01

Chain Spec #2
 Spec Type and Name: Int Manifold Runner Diameter (3 0)
 Starting Spec Value: 1.8
 # Chain: 3 Chain Step: 2
 Preview: Int Manifold Runner Diameter 1.8, 2, 2.2
 Current Value: 2.06

Chain Spec #3
 Spec Type and Name: Int Manifold Runner Length (3 2)
 Starting Spec Value: 3.5
 # Chain: 3 Chain Step: 2
 Preview: Int Manifold Runner Length 3.5, 5.5, 7.5
 Current Value: 5.5

Chain Spec #4
 Spec Type and Name: Exh Header Primary Diameter (5 1)
 Starting Spec Value: 1.7
 # Chain: 3 Chain Step: 2
 Preview: Exh Header Primary Diameter 1.7, 1.9, 2.1
 Current Value: 1.9

Chain Spec #5
 Spec Type and Name: Exh Header Primary Length (5 2)
 Starting Spec Value: 1.7
 # Chain: 3 Chain Step: 2
 Preview: Exh Header Primary Length 1.7, 1.9, 2.1
 Current Value: 1.9

Specs to Chain: 1 2 3 4 5 6

Options:
 Maintain at least: 8" idle vacuum
 Rank Results: Average Tq
 324 total Chains Calcs (9 RPMS each)
 Est Time: 184 min or 3.07 hrs

Callouts:
 - Another change in v3.5 is that the program will rank all the results based on average or peak torque or HP (4 choices). It will then only display the top 5 to 35 (selectable in Preferences) based on this ranking. See results below.
 - Version 3.5 lets you omit results where the idle vacuum is not high enough. This is useful if you need to keep an engine driveable for the street.
 - A time estimate is shown here, which can be well over 100 hours if you specify too many chain settings or RPMS.

Chain Calculations work much like in v2.1 and v3.3 (as shown on page 72 of this book), except in v3.3 you can set 6 different specs to chain, not just 2.

Engine Analyzer Pro Engine [Iv2.1 98-WNSTN.CUP] Test Results [1ckexh\big chain]

Chain Results Options
 Maintain at least: 3" idle vacuum Rank Results: Average Tq
 Refresh

Engine RPM	4000	4500	5000	5500	6000	6500	7000	7500	Average Tq	Average HP	Peak Tq	Peak HP
Chain # 49 (3.0" Hg Idle Vac)												
InPtDia=1.8 InRnDia=1.8 InRnLen=5.5 Tq	429	489	555	578	563	570	551	511				
ExPtDia=1.9 ExPtLen=25 HP	327	419	528	605	643	706	734	741	711	602		
Chain # 169 (3.0" Hg Idle Vac)												
InPtDia=1.8 InRnDia=1.8 InRnLen=7.5 Tq	493	557	561	570	578	566	527	467	419	526		
ExPtDia=1.9 ExPtLen=35 HP	376	477	534	597	660	700	702	666	638	594		
Chain # 85 (3.0" Hg Idle Vac)												
InPtDia=1.8 InRnDia=1.8 InRnLen=5.5 Tq	430	488	542	577	554	562	544	512	473	520		
ExPtDia=2.1 ExPtLen=25 HP	328	419	516	605	633	696	725	731	720	597		
Chain # 157 (3.0" Hg Idle Vac)												
InPtDia=1.8 InRnDia=1.8 InRnLen=5.5 Tq	475	536	559	572	569	577	542	500	441	530	*	*
ExPtDia=1.9 ExPtLen=35 HP	362	459	532	599	650	714	722	714	671	603	*	*
Chain # 61 (3.0" Hg Idle Vac)												
InPtDia=1.8 InRnDia=1.8 InRnLen=7.5 Tq	452	535	557	575	567	558	535	477	428	520		
ExPtDia=1.9 ExPtLen=25 HP	344	459	530	602	648	691	713	682	652	591		
Chain # 193 (3.0" Hg Idle Vac)												
InPtDia=1.8 InRnDia=1.8 InRnLen=5.5 Tq	464	520	559	575	566	570	547	504	453	529		
ExPtDia=2.1 ExPtLen=35 HP	353	446	532	602	646	706	729	719	690	603		
Chain # 97 (3.0" Hg Idle Vac)												
InPtDia=1.8 InRnDia=1.8 InRnLen=7.5 Tq	452	539	547	574	563	540	525	474	437	517		
ExPtDia=2.1 ExPtLen=25 HP	344	462	521	601	644	668	699	677	665	587		
Chain # 313 (3.0" Hg Idle Vac)												
InPtDia=1.8 InRnDia=1.8 InRnLen=7.5 Tq	492	550	561	572	574	548	490	437	388	512		
ExPtDia=2.1 ExPtLen=45 HP	375	471	534	599	655	678	653	624	591	576		
Chain # 241 (3.0" Hg Idle Vac)												
InPtDia=1.8 InRnDia=1.8 InRnLen=7.5 Tq	500	548	553	574	585	512	456	392	349	494		
ExPtDia=1.7 ExPtLen=45 HP	380	469	527	601	645	633	600	569	531	549		
Chain # 277 (3.0" Hg Idle Vac)												
InPtDia=1.8 InRnDia=1.8 InRnLen=7.5 Tq	452	549	559	572	573	543	480	422	375	507		
ExPtDia=1.9 ExPtLen=45 HP	375	471	532	599	654	672	640	602	571	568		
Chain # 205 (3.0" Hg Idle Vac)												
InPtDia=1.8 InRnDia=1.8 InRnLen=7.5 Tq	482	555	565	573	573	563	533	473	425	527		
ExPtDia=2.1 ExPtLen=25 HP	367	476	539	609	654	696	711	676	647	596		

Callouts:
 - Once chain calculations are done, you can change the ranking and idle vacuum criteria, and click on the Refresh button to have the results change, without redoing the calculations.
 - The asterisk indicate the highest Average Tq and HP.
 - Chain results consist of 3 rows of data, with the labels showing Idle Vacuum, a Tq row and HP row. The settings/modifications of the particular chain is also shown here in the labels.

Figure A36 New See-Engine Features

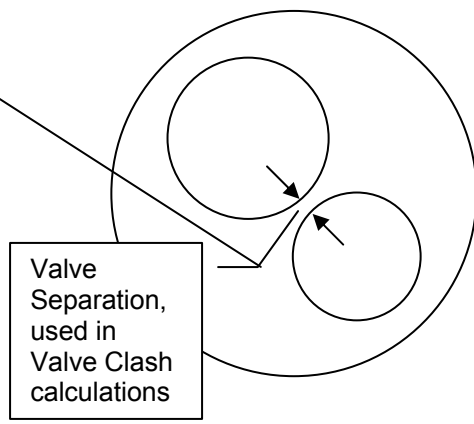
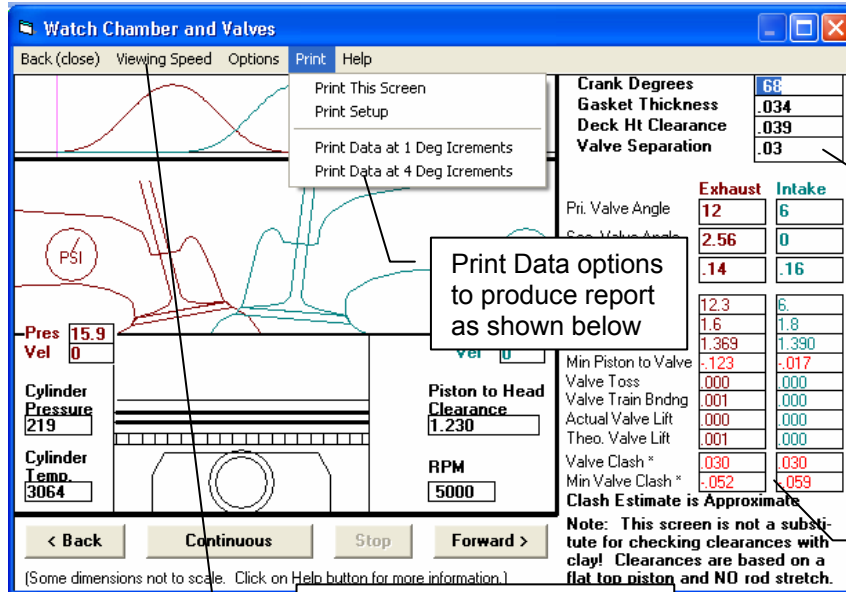

The screenshot shows a Notepad window titled 'WATCHDAT.TMP - Notepad' containing a data report. A callout box points to the 'Viewing speed to speed up or slow down animation' controls. The data report includes columns for RPM, Crank Deg, Piston Depth, Int Lift, Exh Lift, Int PSI, Exh PSI, Cy1 Temp, Cy1 PSI, Int CClear, Exh CClear, Int CClash, and Exh CClash.

RPM = 5000	(data in inches)										
Crank Deg	Piston Depth	Int Lift	Exh Lift	Int PSI	Exh PSI	Cy1 Temp	Cy1 PSI	Int CClear	Exh CClear	Int CClash	Exh CClash
64	1.047	.000	.001	21.5	15.9	3163	244.2	1.280	1.259	0.030	0.030
68	1.157	.000	.001	21.8	15.9	3064	219.2	1.390	1.369	0.030	0.030
72	1.269	.000	.002	21.9	15.9	2973	197.9	1.502	1.480	0.030	0.030
76	1.381	.000	.003	21.9	15.9	2888	179.9	1.614	1.591	0.030	0.029
80	1.494	.000	.005	21.7	15.9	2809	164.4	1.727	1.702	0.030	0.029
84	1.605	.000	.008	21.4	16.0	2736	151.1	1.838	1.811	0.030	0.028
88	1.715	.000	.011	20.9	16.0	2668	139.5	1.948	1.918	0.030	0.028
92	1.824	.000	.015	20.2	16.6	2600	129.2	2.057	2.022	0.030	0.027
96	1.930	.000	.020	19.7	17.3	2555	122.9	2.163	2.123	0.030	0.026
100	2.033	.000	.025	18.9	18.7	2488	114.0	2.266	2.221	0.030	0.025
104	2.132	.000	.032	18.0	20.2	2420	105.9	2.365	2.314	0.030	0.023
108	2.228	.000	.040	17.1	21.5	2353	98.2	2.461	2.402	0.030	0.022
112	2.320	.000	.049	16.2	22.7	2286	91.1	2.553	2.485	0.030	0.020
116	2.408	.000	.059	15.4	23.6	2221	84.5	2.641	2.563	0.030	0.017
120	2.490	.000	.070	14.6	24.5	2158	78.5	2.723	2.635	0.030	0.015
124	2.569	.000	.083	13.9	25.3	2097	73.0	2.802	2.700	0.030	0.012
128	2.642	.000	.098	13.3	25.9	2037	67.9	2.875	2.759	0.030	0.009
132	2.710	.000	.114	12.7	26.4	1979	63.1	2.943	2.812	0.030	0.006
136	2.772	.000	.131	12.2	26.9	1922	58.5	3.005	2.857	0.003	0.030
140	2.830	.000	.150	11.8	27.1	1864	54.2	3.063	2.896	0.003	0.030
144	2.882	.000	.171	11.4	27.1	1807	50.2	3.115	2.928	0.003	0.030
148	2.929	.000	.193	11.0	27.1	1751	46.3	3.162	2.953	0.003	0.030
152	2.970	.000	.217	10.7	27.0	1697	42.7	3.203	2.971	0.003	0.030
156	3.006	.000	.242	10.5	26.7	1646	39.4	3.239	2.983	0.003	0.030
160	3.036	.000	.268	10.3	26.3	1597	36.4	3.269	2.988	0.003	0.030
164	3.061	.000	.295	10.3	25.6	1553	33.6	3.294	2.986	0.003	0.030
168	3.080	.000	.323	10.3	24.9	1512	31.2	3.313	2.978	0.003	0.030
172	3.094	.000	.352	10.4	24.1	1475	29.1	3.327	2.964	0.003	0.030
176	3.103	.000	.381	10.6	23.3	1441	27.2	3.336	2.943	0.003	0.030
180	3.106	.000	.411	11.0	22.5	1412	25.7	3.339	2.918	0.003	0.030

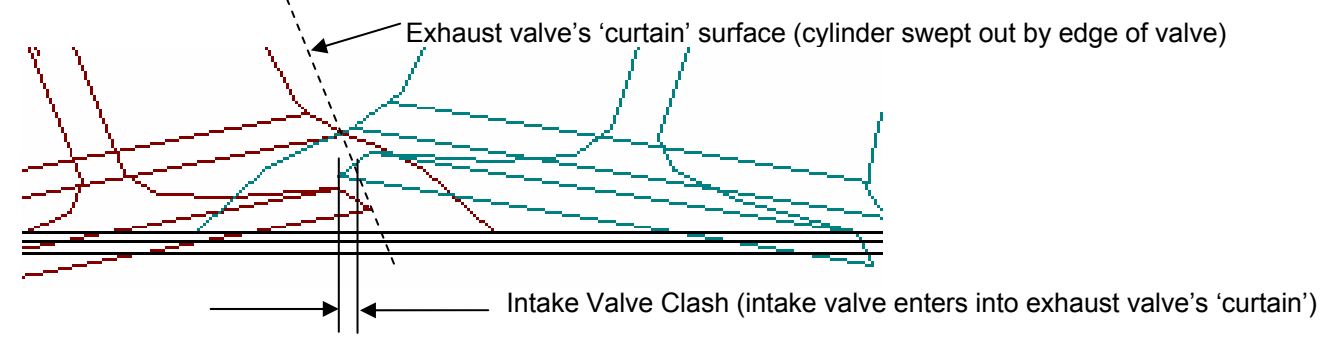
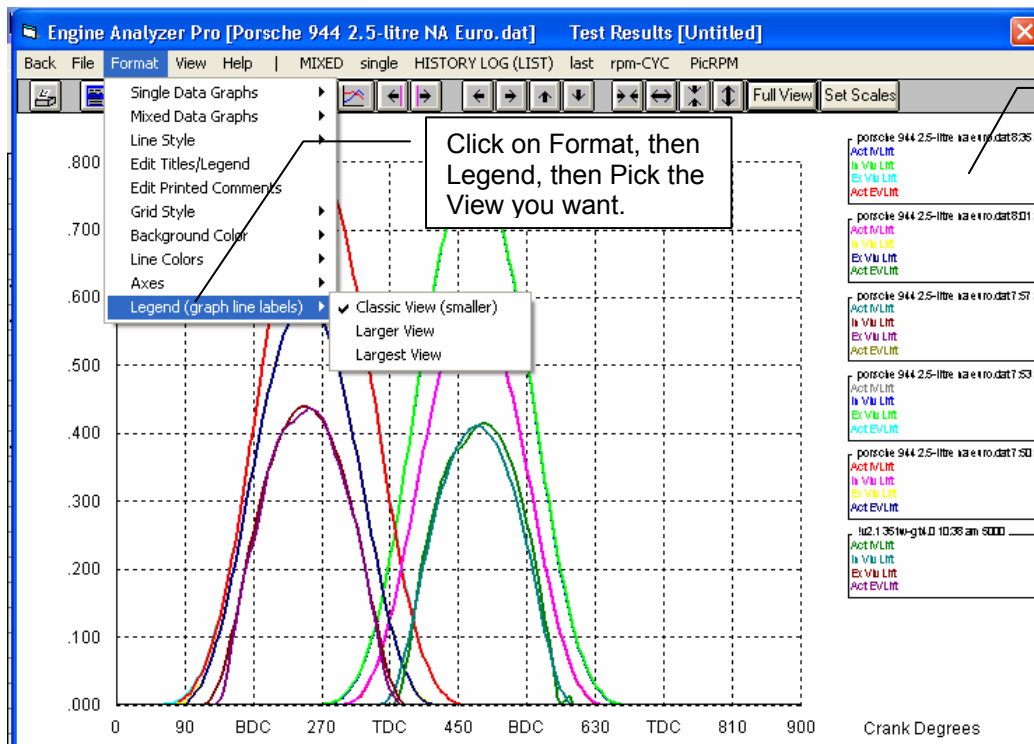

Figure A37 New Options to Format the Graph Legend (labels)



Classic View can be quite small and difficult to read if you have lots of graph lines.

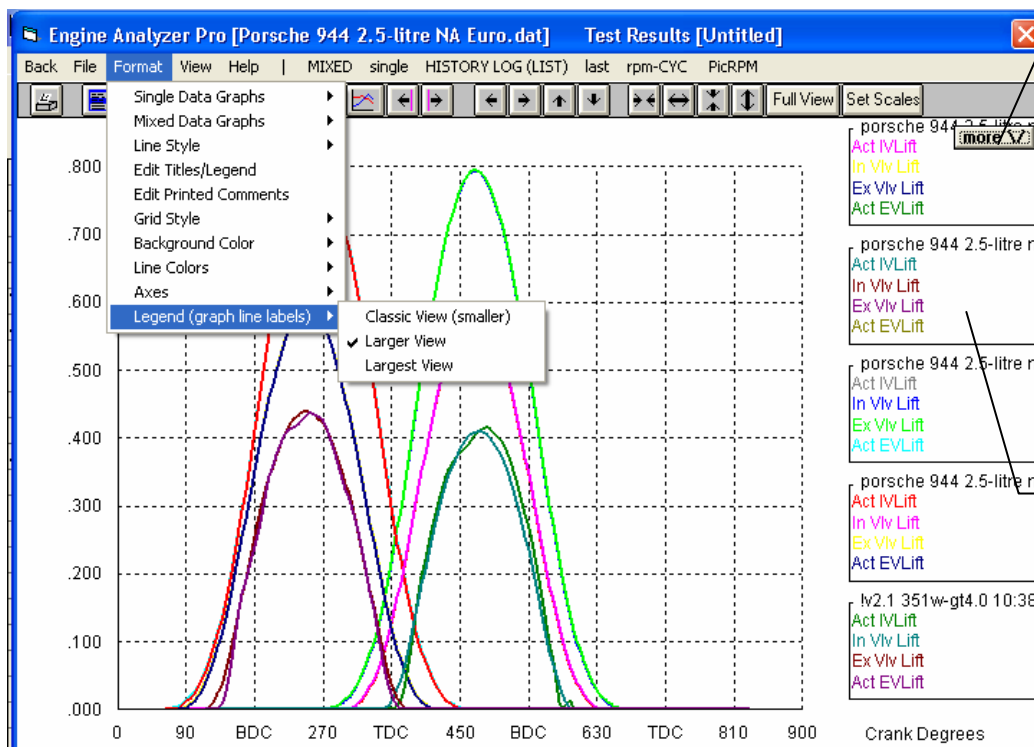

Figure A38 New Ramp Rating for Describing Cam Profiles in More Detail

Select one of the 'Spec' Lifter (profile) Types to get the Ramp Rating inputs to display.

Intake Profile	Exhaust Profile
110	106
220	224
0	38
40	6
.32	.33
.022	.024
.01	.01
1	1
Aggr Solid Flat	Aggr Solid Flat
.33	0 Deg-Std Profil
0	133.3

Enter a Ramp Rating from 0 (very mild) to 100 (very aggressive). Click on the "Clc" button to calculate a rating from other inputs.

Cam Profile	Intake Profile	Exhaust Profile
Centerline, deg ATDC	110	106
Duration @ .040 "	220	224
Open @ .040 ", BTDC	0	38
Close @ .040 ", ABDC	40	6
Max Lobe Lift, in	.32	.33
Actual Valve Lash, in	.022	.024
Designed Valve Lash, in	.01	.01
Rocker Arm Ratio	1	1
Lifter (profile) Type	Spec Solid Flat	Aggr Solid Flat
Ramp Rating, %	0	Clc
Gross Valve Lift, in	.32	.33
Dwell Over Nose	0 Deg-Std Profile	0 Deg-Std Profile
Duration @ .200"	107.0	133.3
Use a Cam File	<input type="checkbox"/> Yes	<input type="checkbox"/> Yes

Calculated Ramp Rating: 44.4

Other info for these results: Duration @ Seat Timing: 216, Minimum Tappet Dia, in: .559

Select what specs you want to calculate a Ramp Rating From: Based On: Duration @ .050" & .200"

Enter your specs here, some are preloaded with specs from the Cam Screen: Max Tappet Lift, in: .4, Designed Valve Lash, in: .028, Rocker Ratio: 1, Duration @ .050": 240, Duration @ .200": 160

Click on Help for more up to date info.

Graph of different Ramp Ratings: 50%, 25%, 0%

Fig A39 New Calculation Menus

Calc Intercooler CFM Rating

Calc Intercooler Rating: 174

Est Intercooler Effectiveness: 64.7

Flow Data / Measurements

Do you have Flow Data? No

Flow Bench Flow, CFM: []

Bench Test Pres, " water: []

Length of Tubes, in: 15

Width of Intercooler, in: 10

Thickness of Intercooler, in: 2

Notes: Intercooler manufacturers should provide this information, but seldom do. Flow the intercooler on a tunical flow bench used for flowinn heads.

Calc Maximum Flow, CFM

Calc Maximum Flow, CFM: 385

Turbo Data

Rating Type: Mass Flow, Kg/min

Maximum Flow Rating: 12

Notes: This calculation will convert various Max Turbo Ratings (for a single turbo) to a Maximum Flow in CFM.

Calc R.A. Stiffness

Calculated R.A. Stiffness: 28945

Calculated Lost Lift: .022

Test Results

Method: Find Lost Lift from Spring

Force on R.A. Tip, lbs: []

Deflection of Tip, in: []

Spring Rate, lbs/in: 700

Seated Spring Force, lbs: 200

Expected Max Valve Lift, in: .624

Measured Max Valve Lift, in: .602

Note: See Figure 2.50, p 118 in manual for description of first test method 'Apply Force to Rocker Arm

Fig A40 New Turbo Inputs

Turbocharger Specs for: TWN-ICTU.RBO

1st Stage Turbocharger Specs

- Island CFM: 300
- Island Pressure Ratio: 1.8
- Surge CFM: 74
- Exh Turbine Eff. %: 65% Typical
- Turbine Nozzle Dia, in: 1.38
- Maximum Flow, CFM: 450

General Turbocharger Specs

- Throttle Location: Blow Through
- Max Boost Limit, PSI: 15
- # Turbos/Stages: 2 Twin Turbos
- Intercooler Eff. %: 50% Quick Accel Air-to-
- Intercooler CFM Rating: 100000
- Wastegate Is...: Before Intercooler

Comments

Typical "medium sized" twin turbos with wastegate set to 15 psi (30" Hg) With intercooler

Callouts:

- Many more choices for Turbine Efficiency (pointing to Exh Turbine Eff. %)
- This input lets you define the highest flow the turbo compressor can efficiently flow. (pointing to Maximum Flow, CFM)
- This tells program if wastegate is controlling to a pressure before or after the Intercooler. (pointing to Wastegate Is...)

Buttons: OK, Help, Retrieve from Library, Save to Library, Print

Figure A41 Features and Settings for Emailing Files

Preferences - Emailing

- My Email Program: Other-use specs below
- IP Address: 65.29.127.192
- SMTP Server: smtp-SERVER.twini.com
- Sender Email Address: kevin@performancetrends.com
- Path to MSPaint: c:\windows\system32

File (engine) Menu

- Email Engine File
- Import Individual Files
- Import All Files from Earlier Engine Analyzer Pro
- Unlock Program Options
- Transfer Program to Another Computer
- Exit Program

Printout Options

- Include Engine Specs
- Include Engine Comments
- Request Report Comment
- Dot Matrix Printer Adjustment
- Include Special Calcs
- Email as PDF (tm) File

Email To: Dialog

Email to: marksmith@aol.com

Message to Send: Here's that Porsche file I've been talking about

File to Attach and Send: Engine: Porsche 951 turbo Big 4.txt

Engine Analyzer Pro [Porsche 951 turbo Big 4]

- Print Black & White (dashed lines)
- Print Color (solid lines)
- Windows Print Options
- Email 256 Color Graph
- Email 16 Color Graph

Callouts:

- Emailing Preferences. Click on Help button in Preferences for more info. (pointing to Preferences dialog)
- Emailing a Total Engine File from the Main Screen. (pointing to File menu)
- Form used for emailing all types of files. Email addresses you enter are added to the list. (pointing to Email To dialog)
- In tabular Results, click on Print to send an Email of Results. (pointing to Print menu)
- Select this option to email a PDF file. (pointing to 'Email as PDF (tm) File' in Printout Options)
- Click on File, then one of these email options to email a graph as a .bmp file. (pointing to 'Email 256 Color Graph' and 'Email 16 Color Graph')

Figure A42 File Backup and Restore Options

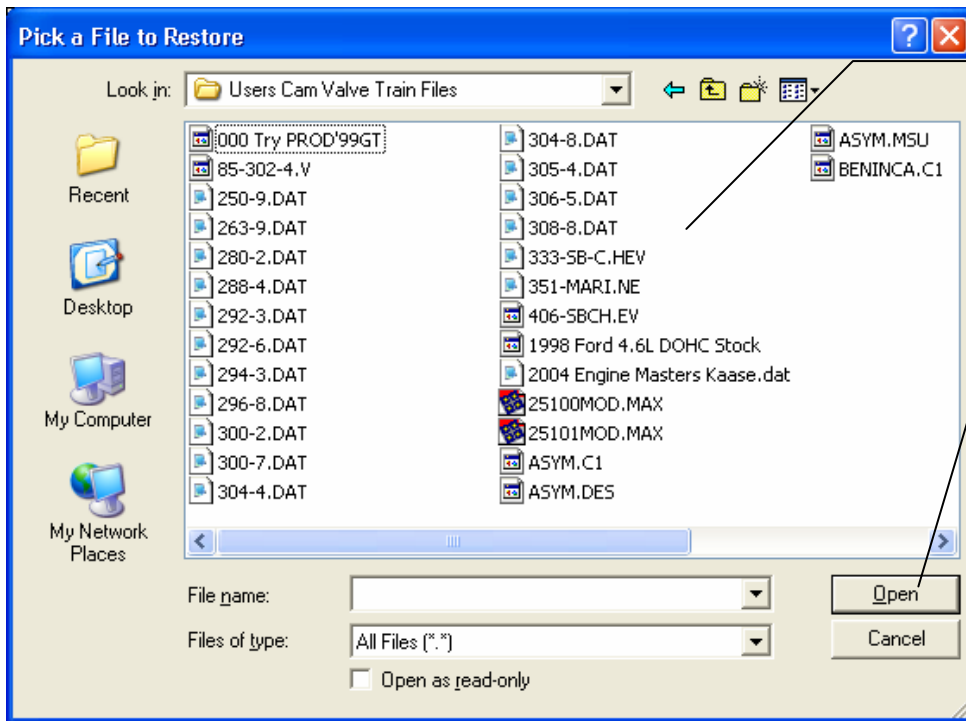
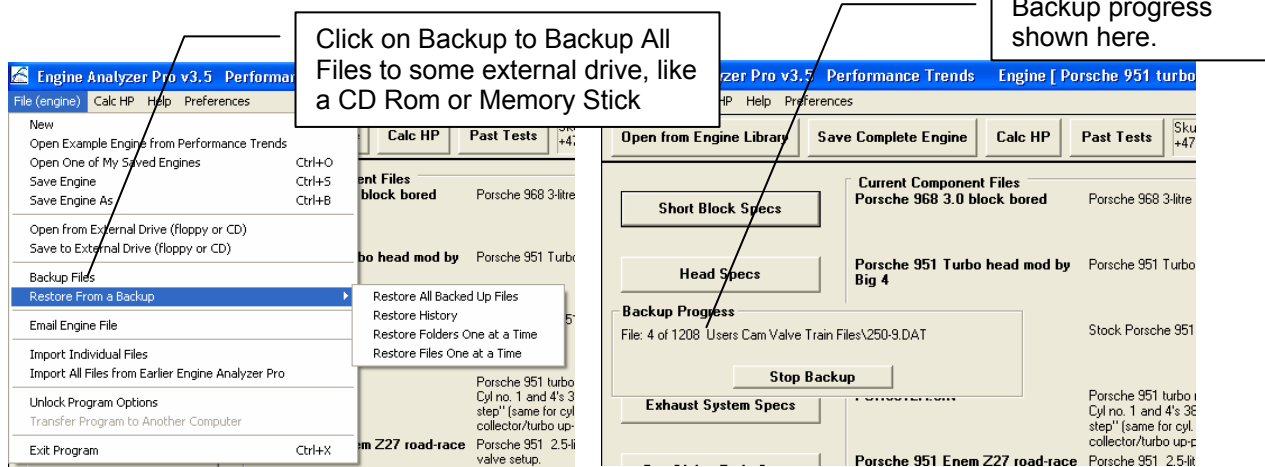

For some of the Restore options, you can pick the file you want to restore. If you have chosen to restore an entire folder, pick one of the files in that

Once you have picked a file, click on the Open button to start the Restore process.

IMPORTANT: Be very careful when restoring files. You can overwrite more recent files with changes you want to keep with older files, if they have the same name. You may want to make a backup of all your files as they currently exist before restoring files. That way if you loose some files, you can restore them.

Appendix 11: New Features in v 3.9

Engine Analyzer Pro has had many updates since this user manual was written for the original v2.1 for Windows. These include v2.1 B, v2.1C, v2.1D, v3.3, v3.5 and now v3.9. Here is a brief listing of some of the features new since v3.5 was released, including Version 3.9:

New Features:

The screen for opening standard Engine Analyzer Example Cams now shows the Gross Valve Lift and Lobe Separation for the cam you selected if you right click on the selected cam. Fig A44.

The screen for opening standard Engine Analyzer Example components now lets you select to only show components which match up to 3 criteria you have selected at the bottom of the screen. For example, you can choose to only show "Crawler" cams with a lobe lift greater than .330 inches. Fig A44.

The screen to pick a Category of standard Engine Analyzer examples is now more intuitively obvious as to how it works, and it also remembers your last choices which will save time when you use this feature often. Fig A43.

We've now added 'Chain Calc These Cams' button when displaying standard Engine Analyzer example cams. This will have the program calculate performance for all cams in the list which meet the criteria of 'Show Examples Only Fitting These Limits'. Fig A44.

You can include a graphics file, which could be your company logo, when printing graphs and reports. This file is loaded in via the Preferences screen. Fig A45 and Fig A49.

You can include add dyno power curves which you have entered manually to a graph. This lets you make comparisons between actual dyno performance and the Engine Analyzer Pro's simulated results. Soon we will be exporting power runs from our Dyno DataMite software to the Engine Analyzer Pro. The default location for these files is the "engine" folder in the Engine Analyzer Pro v3.9 folder. Fig A48.

You can now import Cam Analyzer files almost seamlessly. The Pro will now install the cam nearly exactly as measured, even if the lobe is asymmetric. Fig A56.

You can now email results as a simple text file now in Print Options, which does not require a PDF writer program like Adobe Acrobat.

Program now remembers the ASCII file name and path, and which data channels have been selected to be output in an ASCII file.

Program now better accommodates the first column in printouts if the title in the left column is very long, like for a chain calculation. Fig A44.

A new Preference has been added under "General Operation, cont" tab to let you hide the Progress Bar during calculations. This lets you minimize the program during calculations to work with other programs, which can be very handy when doing long chain calculations. Fig A45.

We've now added Delete Row and Insert Row buttons to the Flow Table screens in Head Specs. Fig A47.

You can now select to include the torque and HP data when you print out RPM data graphs as long as there are torque and/or HP data on the graph. Click on the Tq / HP Data option. Fig A49.

The program now has a separate ASCII File command in the Output Screen to make it more obvious you can export the data as ASCII data.

Now program can now better find newer versions of Acrobat or Acrobat Reader to display the user's manual, supplements, and more. You can also 'browse' to find Adobe Acrobat in the Preferences screen. Also, the program now allows other "PDF Writing" programs produce PDF files for emailing, other than just Adobe programs.

Program now better remembers the printer you have selected and landscape vs portrait when you click on Windows Printer Setup in various screens.

Some printouts now use a proportional font for better printouts.

Program now remembers its screen position and window size and restores it when it is opened again.

Now program should require you to 'Allow' it to run in Vista (same as right click on desktop icon, then select Run As Administrator'). This should make the program more Vista compatible.

New Inputs:

The program now lets you enter various types of ethanol fuels, like E85, and other percents of ethanol and gasoline. It now also has a Richness factor input which makes it easier to pick different types of fuels and richness factors. Fig A50.

You can now specify a variable cam timing, or Variable Valve Timing (VVT). This lets you specify a particular RPM where the program switches from the base cam timing to a modified cam timing and lift. This can be for the intake and/or cam profiles. Fig A53.

You can now specify an amount of Asymmetry to a cam profile being created in the program. Fig A52.

You can now specify up to 6 break points in spark curve. It was previously limited to just 4.

We've added a "Clc" button for Lobe Lift being calculated from Gross Valve Lift and Rocker Arm Ratio in the Cam Specs.

We've added several general intake manifold types. These choices let you pick a manifold type and the program will estimate various measurements based on the engine size and intake port size in the Head Specs screen. You can see what the program has estimated for these specs. Then if you change the type to "Use Specs Below", you can modify these to your liking. Fig A51.

The Centrifugal Superchargers now have a Max Airflow input. This allows the program to better fine tune the supercharger performance map within its calculations.

We've added hundreds of new standard Engine Analyzer Example cams, including Comp Cams, Crower, Isky, Lunati, Harley Davidson, and production cams. Hundreds of these are for stock engines courtesy of John Holm. Many thanks John. Many of the Harley Davidson cams are courtesy of Stephen Mullen of S&P Mullen Enterprises, Inc www.Nightrider.com or www.tuneyourharley.com. Many thanks Stephen.

We've added several new standard Engine Analyzer Example cam categories, especially Imports. Fig A43.

You can now specify .053" lift for rating cam events (like Harley Davidson cams).

We've added an option to import Other Format Files for Head files, like .flw and .dfw files from Desktop Dyno (tm) and DynoSim (tm). Hundreds of compatible head files with flow data, valve sizes, and some with port volume (not available with typical Desktop Dyno or DynoSim files) are available via Stan Weiss at <http://users.erols.com/srweiss/tablehdc.htm> You can purchase a CD from Stan with all the files or just visit his site for free info for your particular heads. I believe if you purchase the CD, everything will be in the correct format and you may have additional data not free on the website, like port volume. Note: Not all head files have port volume, material, etc. Fig A54.

We've added an option to import Other Format Files for Cam files, like .cam and .scm files from Desktop Dyno (tm) and DynoSim (tm). Fig A55.

Program now has section for storing comments about the valve train dynamics specs.

We've added several new Chevy LSx and LTx example files of both Components and Total Engines courtesy of Aaron Anderson. Many thanks Aaron.

We've added many example Garrett turbocharger files, courtesy of Bjørn Deildok of SWR Performance, Norway. Many thanks Bjorn.

We've added the ability to calculate turbo turbine Nozzle Diameter based on exhaust turbine flow data.

The program now asks if you want to use an unrecognized cam file format. This can help if you have a file which is not *exactly* the correct format but still useable.

New Outputs:

We've added Sq In Area and Port Volume to the Head Specs screen.

We've added a new Preference under "Calculations, cont" tab to let you pick the number of decimal places to use to display torque and HP. This does NOT improve the accuracy of the calculations. Fig A46.

We've added 2 new Preferences to allow all or user selected outputs to be displayed in Metric units. Fig A46.

We've modified the Preference setting of 'Include Averages in Chain Results' to 'Chain Results Include' either No Averages, Average Tq and HP, and now Avgs + Engine Masters Challenge. The Chain Calculations now include the engine Displacement in CID with Idle Vacuum to provide the info necessary for this calculation. The calculation is:

$$\text{Engine Masters Challenge Score} = (\text{Avg Tq} + \text{Avg HP}) \times 1000 / \text{cid}$$

The Average torque and HP is calculated over the RPM range you have selected to calculate. The Engine Masters Challenge rules can change from year to year, and will determine the RPM range. You can also rank your chain results based on this EMC Score. See Fig A44 for results and Fig A45 for the Preference Setting.

Accuracy Improvements:

We've improved the accuracy of Roots Supercharger simulation at very low RPMs which would typically produce very low boost levels.

We've made some improvements to the calculation about the amount of boost or exhaust pressure required to blow the valves off their seat.

We've made some improvements to the tables of Spring Force vs Spring Height, available in the Valve Train Dynamics screen.

We've added a Preference for Filter (smooth) Cam Lobe File data. Since Cam File data can come from many different sources, it may be best to set this to Yes, especially if you are doing Valve Train Dynamics. Fig A45.

If you are using a Cam Lobe File for either the intake or exhaust lobe, then the velocity and acceleration data for this lobe will be filtered also.

We've increased the "Number of Cam Bearings" allowed up to 40 (was 20) for calculating Bearing Size Coef. in Short Block Specs.

We've fixed a bug where direct acting OHC buckets would show valve toss at very low RPM (less than 1000) due to math problem.

We've refined the blow-by calculations, so that the amount of leakage also reflects a loss of fuel energy due to lost fuel.

The program now allows for up to 20 degrees cam advance or retard.

We've made refinements to the Estimated Idle Vacuum in the Special Calculations section. Now it is based on the Barometer setting in the Calculation Conditions screen, supercharger type, and some other refinements.

We've added a Preference to have Cranking Compression calculated by cranking RPM, barometric pressure, and cylinder leakage, or just the simpler v3.5 and earlier versions. For a little background, if there is any leakage as specified in the Short Block Specs screen, that bleeds off cranking compression. The faster you spin the engine to recording cranking compression, the less time available to leak and the higher the pressure. Also, the higher the barometric pressure, obviously the higher the cranking compression. Fig A46.

Lifts at TDC are now done with NO lash, to better match what most cam grinders report.

We're now doing a more precise simulation of the difference between aluminum vs cast iron heads for Knock Index difference.

We've increased the Piston Speed limit above which program says is Impossibly High because materials and technology have made huge improvements over the years.

We've made some refinements to the Cam Profiles created by the EA Pro to more precisely time them to the nearest 0.1 deg.

Figure A43 New Features for Using Standard Engine Example Component Files

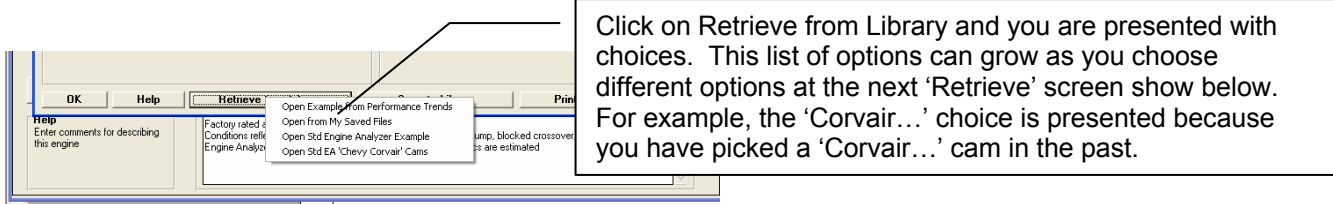

Click on Retrieve from Library and you are presented with choices. This list of options can grow as you choose different options at the next 'Retrieve' screen show below. For example, the 'Corvair...' choice is presented because you have picked a 'Corvair...' cam in the past.

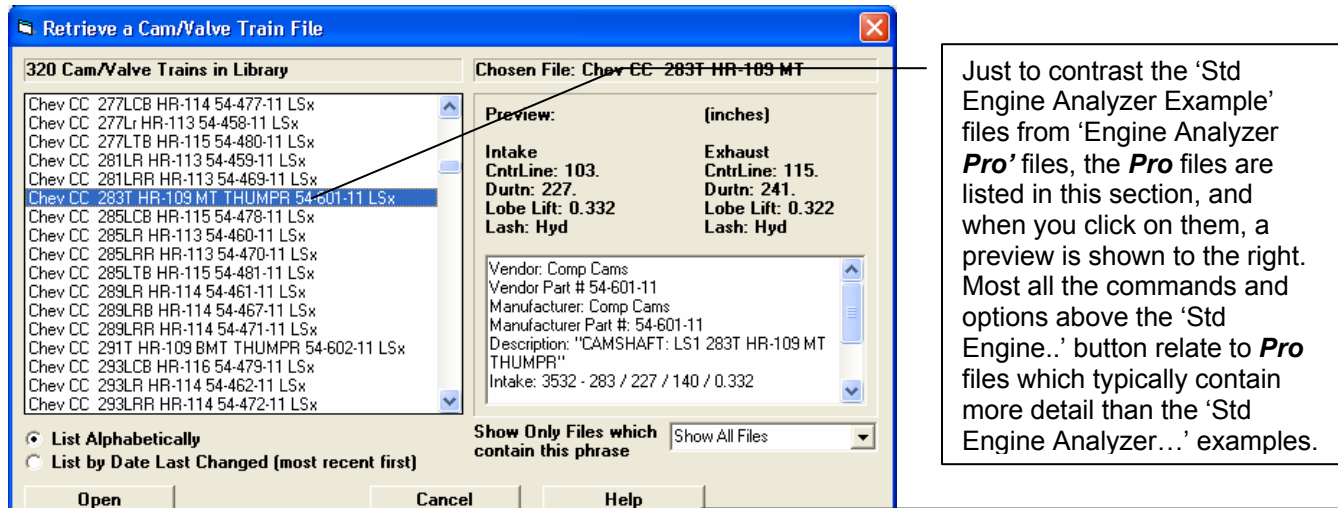

Just to contrast the 'Std Engine Analyzer Example' files from 'Engine Analyzer Pro' files, the Pro files are listed in this section, and when you click on them, a preview is shown to the right. Most all the commands and options above the 'Std Engine..' button relate to Pro files which typically contain more detail than the 'Std Engine Analyzer...' examples.

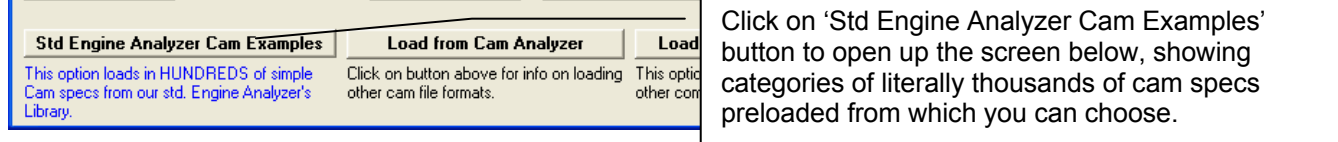

Click on 'Std Engine Analyzer Cam Examples' button to open up the screen below, showing categories of literally thousands of cam specs preloaded from which you can choose.

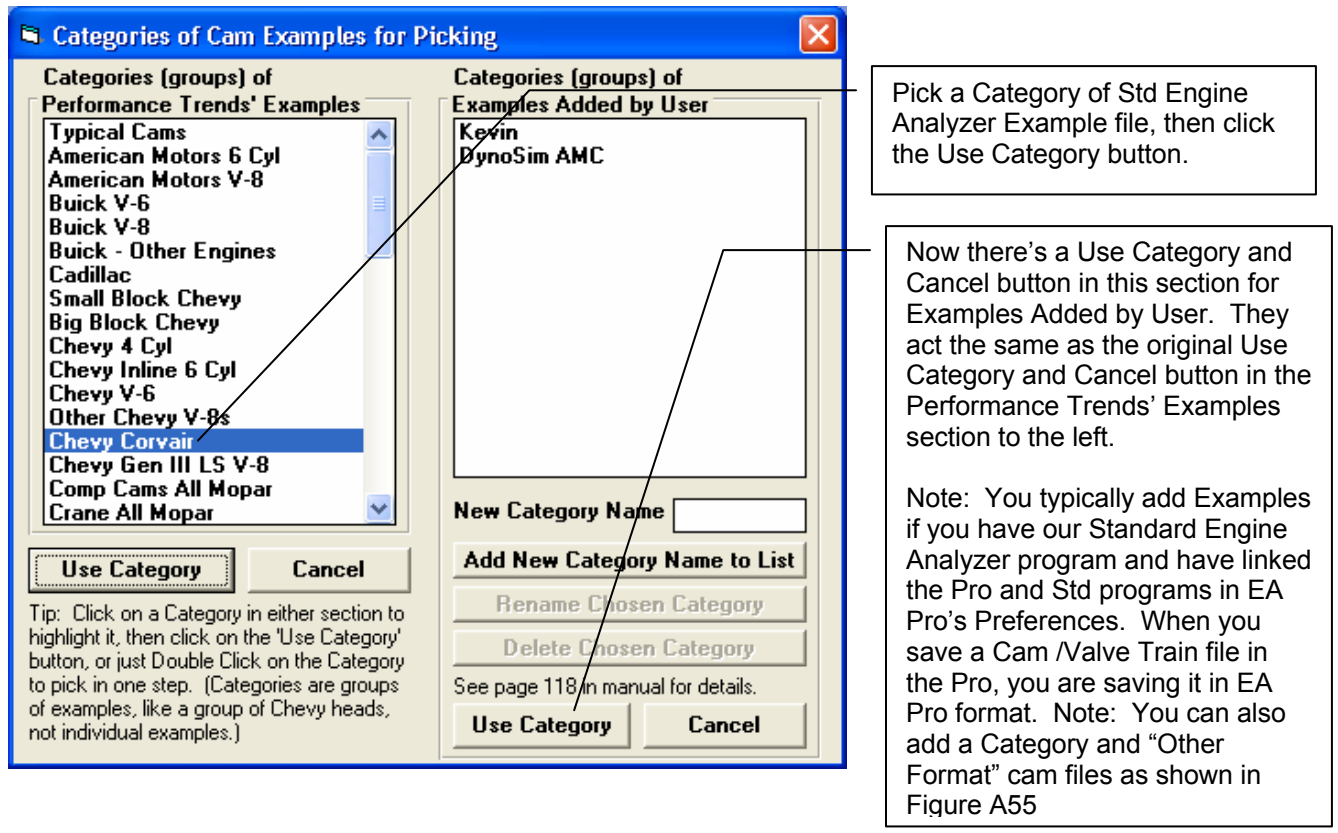

Pick a Category of Std Engine Analyzer Example file, then click the Use Category button.

Now there's a Use Category and Cancel button in this section for Examples Added by User. They act the same as the original Use Category and Cancel button in the Performance Trends' Examples section to the left.

Note: You typically add Examples if you have our Standard Engine Analyzer program and have linked the Pro and Std programs in EA Pro's Preferences. When you save a Cam /Valve Train file in the Pro, you are saving it in EA Pro format. Note: You can also add a Category and "Other Format" cam files as shown in Figure A55

Figure A44 New Features for Using Standard Engine Example Component Files, cont

If you right click on a cam you have picked (which will be highlighted in blue as shown here), several calculated parameters for that cam are shown.

In this section, you can choose to Show... 'All Examples' or 'Only These' as shown. Then you can use the 3 groups of conditions to determine what examples are shown. For example, in this screen, we have picked to only show cams with the phrase 'Hyd' in the Lifter Profile description **and** an Int Lobe Lift greater than .29 inches.

Click on this button (only available for example Cams) and the program will do a chain calculation on all cams listed

Other Chevy Corvair Flat 6 Cams	Rated Lift	Lifter Profile	Valve Train	Center Line	Dur	Lobe Lift	Valve Lash	Rocker Ratio	Ramp Rating	Source/Comments
Isky CORVAIR (exh)	.050	SpecHydFit	P+RA imp	108	202	.3	na	1.5	32.5	PN: 115125 HYDRA
Isky CORVAIR (exh)	.050	SpecHydFit	P+RA imp	104	208	.297	na	1.5	35.1	PN: 115126 HYDRA
Isky CORVAIR (exh)	.050	SpecHydFit	P+RA imp	104	224	.311	na	1.5	35.7	PN: 115128 HYDRA

Gross Valve Lift for Highlighted Cam
 Intake: .311 x 1.5 = .4665
 Exhaust: .311 x 1.5 = .4665
 Lobe Separation: 108.0

Abreviations: B/R=Blue Racer CC=Comp Cams Lun=Lunati M=Motorsports Comy Cams Grinds DEH=Duel-Energy XR/E=Extreme-Energy NX=Nitrous-HP
 Tips: Click on Example to highlight it, then click on 'Pick' or 'Delete' button. Double click to pick Example in 1 step. Right click to show Valve Lift.

Buttons: Pick, Delete, Print, Cancel, Chain Calc These Cams

Show Only Examples Fitting These Limits:
 Show... Lifter Profile: Contains Hyd, Int Lobe Lift: Is more than .29, Other Chevy Corvair Flat 6 Cams (1st): Contains

Engine Analyzer Pro Engine [1969 Pontiac GTO 400 Stock] Test Results [Untitled]

Chain Results Options: Maintain at least 3" idle vacuum, Rank Results: Average Tq, Refresh

Engine RPM	3000	4000	5000	6000	Avg	EMC
Chain # 3 (16.0" Hg Idle Vac, 415.63 cid)						
Isky CORVAIR Tq	464.46	494.77	437.78	310.25	426.82 *	
PN: 115128 HYDRAULIC 2500-6500 RPM	265.30	376.82	416.78	354.44	353.34 *	1877.05
Chain # 2 (18.8" Hg Idle Vac, 415.63 cid)						
Isky CORVAIR Tq	482.63	486.52	397.35	266.52	408.26	
PN: 115126 HYDRAULIC 2000-5500 RPM	275.68	370.54	378.29	304.48	332.25	1781.66
Chain # 1 (21.2" Hg Idle Vac, 415.63 cid)						
Isky CORVAIR Tq	478.83	480.82	380.07	250.14	397.47	
PN: 115125 HYDRAULIC 1500-4800 RPM	273.52	366.20	361.84	285.77	321.83	1730.63

Engine Masters Challenge is now a choice for Ranking if you set the appropriate Preference.

A Preference lets you choose to show the Average Torque and HP, and also include the Engine Masters Challenge column in the Chain Calculation results.

The program now better expands this first column to fit all the descriptive data given.

All these torque and HP results (and Engine Masters Challenge Score) are shown to 2 decimal places because that Preference has been turned. If that Preference was not turned on, these numbers would have been shown to the nearest whole number, that 366.20 would be shown as

Results for the Cam Examples you choose to keep in the screen above. Note that these are ranked by 'Average Tq' by any of the 5 choices in the 'Rank Results' combo list. The 'Eng Masters Challenge Score' is only possible if you've turned it on in Preferences.

Figure A45 New Preference Settings

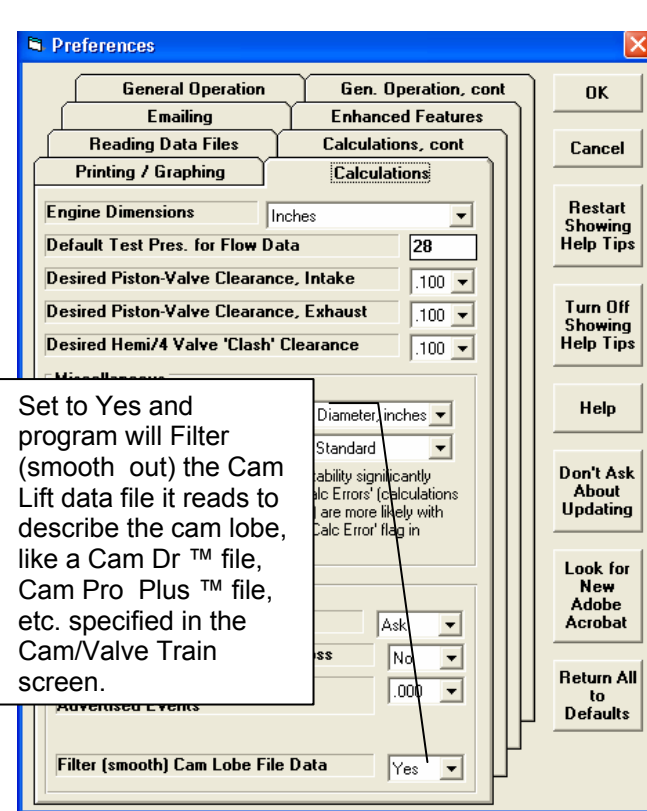
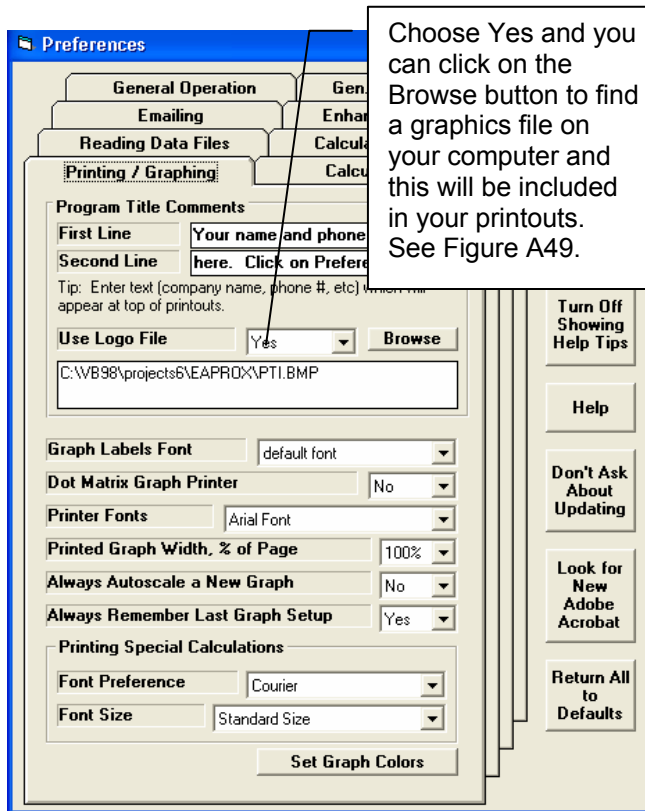
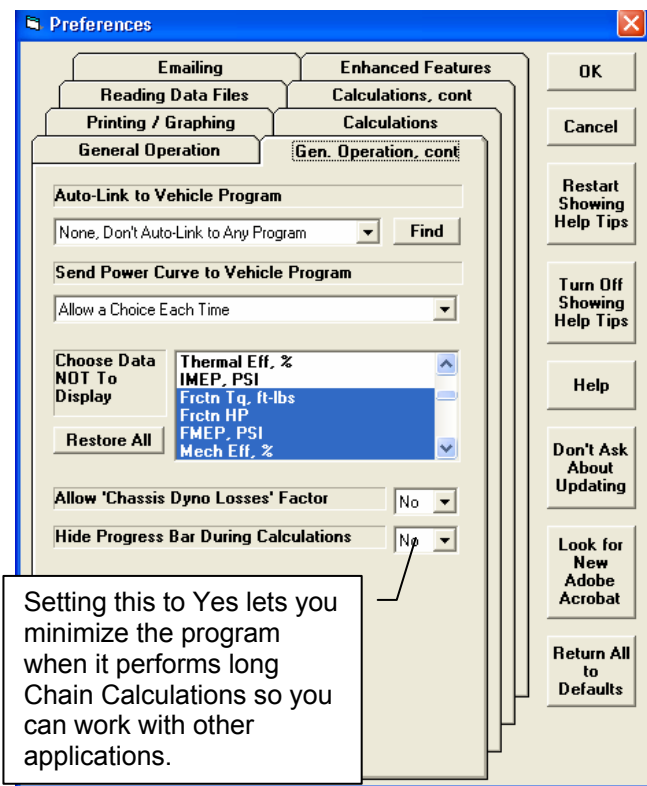
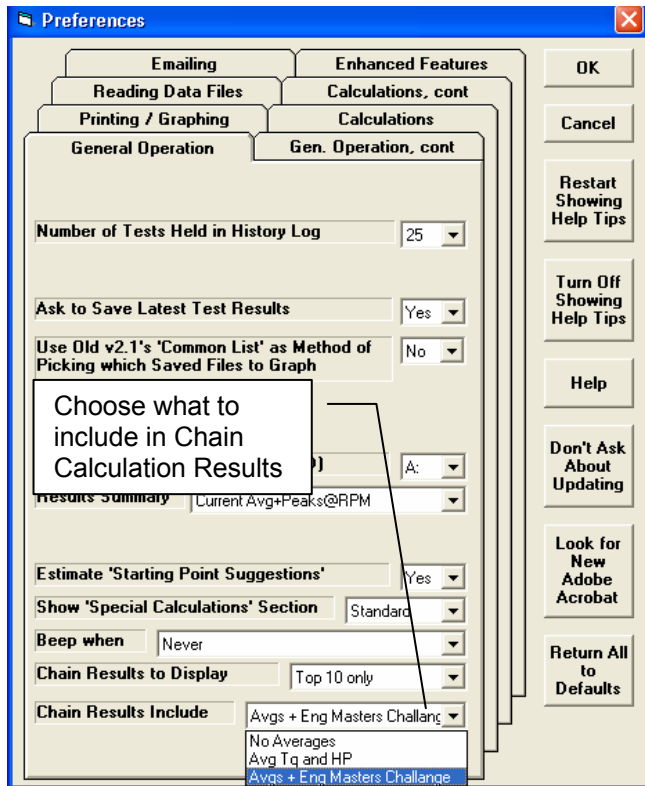

Figure A46 Options in Preferences Under 'Calculations, cont' Tab

Choose if you want more detailed Cranking Compression estimated. If you choose Yes, RPM is enabled for you to

Choose which outputs you want reported in Metric units.

Choose how many decimal places for torque and HP outputs.

If you choose Picked, the Pick from List button is enabled. Click on it to display list of data channels.

Click on the data channels you want reported in Metric units, or click on buttons in this section to Select All or Deselect All. When you have selected the correct channels, click on the Close (keep) button to close this section and keep your Picks.

Perf. Calculations: New v3.5/3.9 Calculations

Cycle Data: Show BTU Heat Release

Write Errors to Error Log File: No

Cranking Compression Estimate: Do More Detailed Estimate: Yes, Cranking RPM for Measurement: 350

Metric Outputs: For RPM Data: None, For Cycle Data: None

Tq/HP Decimal Places: 2 (248.34 HP)

Pick RPM Data list: Secondary Jet, in Calc Error, Compressor Eff. %, Comprsr Pres Ratio, Compressor HP, Compressor RPM, Roots Vol Eff. %, Turbo Wastegt. %, Turbo Surge. %

Buttons: Close (keep), Cancel, Select All, Deselect All, Help, Look for New Adobe Acrobat, Return All to Defaults

Figure A47 Flow Data Table Screen (from Head Specs Screen), New Commands

Intake Flow for 28 Inches Water Pressure 1 Valve, 2.4" dia

Valve Lift, in	Valve L/D	Flow, CFM	Flow Coef
1	.042	77	.668
.2	.083	166	.720
.3	.125	257	.743
.4	.167	338	.733
.5	.208	392	.680
.6	.250	421	.608
.7	.292	410	.592
.8	.333	419	.605

Graph: Flow, CFM vs Valve Lift, inches

Buttons: OK/Save, Help, Print Screen, Clear CFM Only, Print Int+Exh, Clear All Data, Print Setup, Factor Up, Factor Down, Delete Row, Insert Row

Tip: Use

Delete the row where the cursor is positioned, in this case, the 1st row. All rows below this will be moved up 1 row.

Insert a Row at the row where the cursor is positioned, in this case, the 1st row. All rows at this position and below will be moved down a row and the bottom row will be lost.

Figure A48 Including Actual Dyno Curves with Graphs

In Graph screen, click on File, the Actual Dyno Curves, then Enter/Edit Dyno Curve Data to get screen shown to right.

Click here to calculate an approximate power curve. You can then edit those data points.

Click on File for these options to Open or Save this data set.

Type in your RPM, torque and/or HP data points. Once you have entered 2, the 3rd input is calculated and filled in for you.

Click here to include this data on the graph with Engine Analyzer Pro calculated data, as shown below.

RPM	Tq	HP	RPM	Tq	HP
1600	112	34.1			
2000	140	53.3			
2400	166	75.9			
2800	167	89			
3200	169	103			
3600	166	114			
4000	163	124			
4400	159	133			
4800	148	135			
5200	131	130			

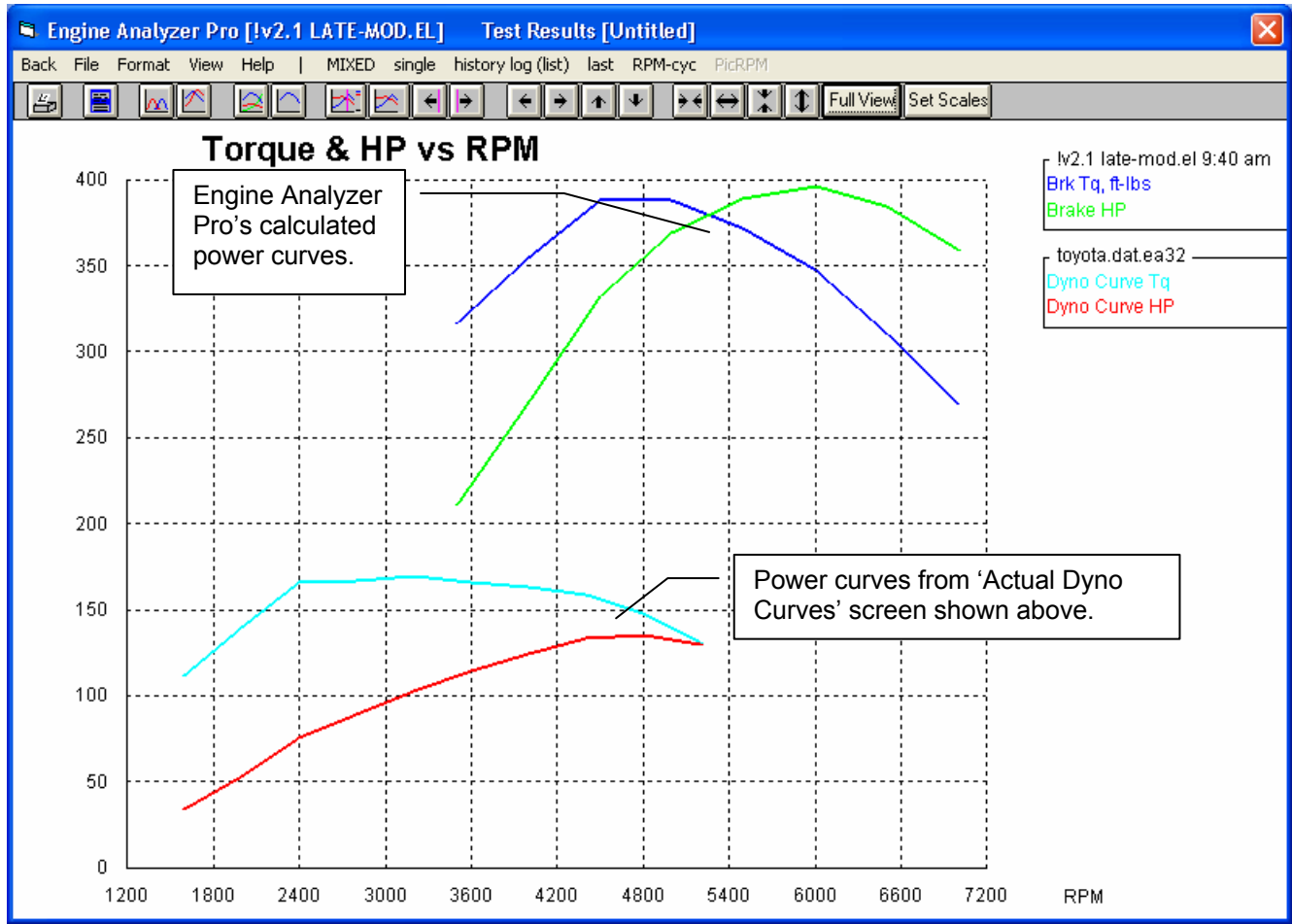

Figure A49 Including a Torque and HP Data Table with the Printed Graph

Click on Format, then Edit Printed Comments to get screen shown to right.

Check Tq/HP Data to include torque and HP data table at the bottom of the printed graph. Note: This data is ONLY printed if the graph includes torque and HP data vs RPM.

Engine Analyzer Pro v3.9
 Eng: lv2.1 LATE-MOD.EL
 Calculated Test Results

Your name and phone # can go here. Click on Preferences.
 Performance Trends (C) 2009

This Graph Printed:
 11:21 am 11-16-09
 Page: 0

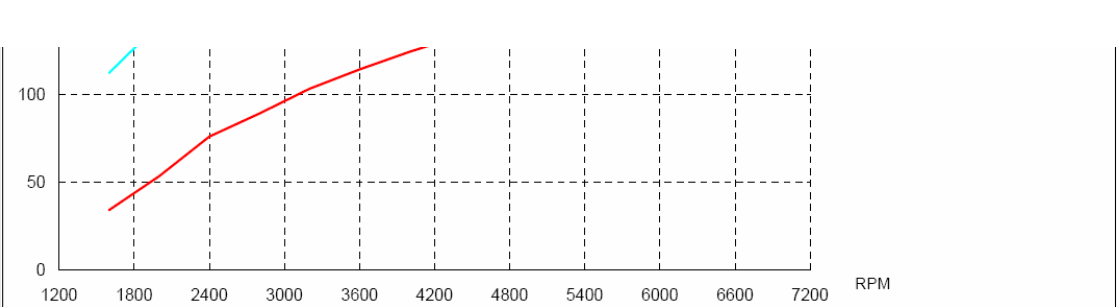
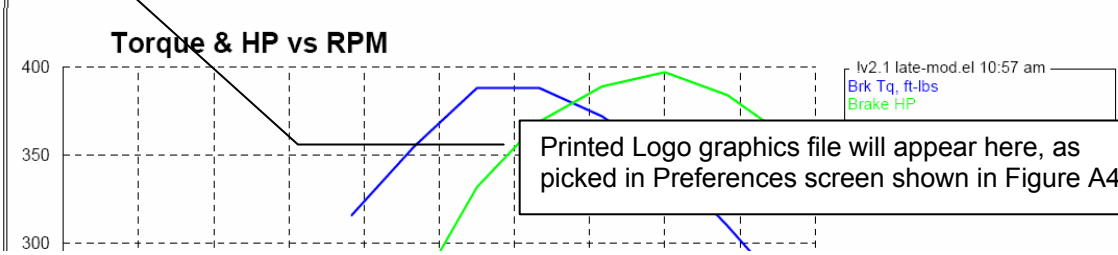

Data Tables appear here, under the graph on printouts.

Data Table for: lv2.1 LATE-MOD.EL 10:57 am							
RPM	3500	4000	4500	5000	5500	6000	6500
Tq	316	355	388	388	372	347	310
HP	211	270	332	369	389	397	384

Data Table for: toyota.dat.EA32									
RPM	1600	2000	2400	2800	3200	3600	4000	4400	4800
Tq	112	140	166	167	169	166	163	159	148
HP	34.1	53.3	75.9	89	103	114	124	133	135

Figure A50 New Ethanol Fuel Choices (like E85) and Separate Richness Setting.

The screenshot shows the 'Calculate Performance Conditions for: 1v2.1 LATE-MOD.EL' dialog box. It is divided into 'Test Conditions' and 'Fuel Specs' sections. The 'Fuel Specs' section includes a 'Type' dropdown set to 'Gasoline', a 'Fuel Richness' dropdown set to 'Typical for best power', and a 'Fuel Octane (R+M)/2' field set to '96'. There are radio buttons for 'No Nitrous Oxide' (selected) and 'With Nitrous Oxide'. A callout box points to the 'Type' dropdown with the text: 'New method of selecting fuel type and Richness factor. The approximate A/F ratio for that fuel is also'. Below the main dialog, two smaller screenshots show the 'Fuel Specs' section with a list of fuel types expanded. The first list includes 'Gasoline', 'Alcohol (methanol)', 'Drag Racing Gasoline', 'E10 (10% ethanol + 90% gasoline)', 'E50 (50% ethanol + 50% gasoline)', 'E85 (85% ethanol + 15% gasoline)', 'E100 (100% ethanol)', and 'Propane (lo-pres. gas)'. A callout box points to this list with the text: 'Here are some of the fuel types, now including ethanol and ethanol blends.' The second smaller screenshot shows the 'Fuel Richness' dropdown expanded with options: 'Typical for best power', '15% Rich of best power', and '30% Rich of best power'. A callout box points to this list with the text: 'These are the available Fuel Richness settings.'

Figure A51 Picking a "Typical" Manifold Type in the Intake Specs Screen.

The screenshot shows two side-by-side views of the 'Intake System Specs for: VCTRJR-2.BRL' dialog box. The left view shows the 'Manifold Specs (1 runner/cyl)' section with a 'Type' dropdown set to 'Use Specs Below'. A list of manifold types is expanded, including 'Typical Production Dual Plane', 'Typical Street Dual Plane', 'Typical Race Dual Plane', 'Typical Production Single Plane', 'Typical Street Single Plane', 'Typical Race Single Plane', and 'Typical Race Tunnel Ram'. A callout box points to the 'Typical Street Dual Plane' option with the text: 'Click on the new input of Type and select either Use Specs Below and you can enter the manifold specs, or choose one of the "Typical" manifolds and the manifold specs will be disabled (as shown to the right) and the program will fill the specs with typical settings for than manifold type based on this engine's size and port size in the Head'. The right view shows the same dialog box with 'Typical Street Dual Plane' selected in the 'Type' dropdown. The 'Manifold Type' dropdown is now set to 'Dual Plane-carb(s)'. The manifold specifications fields (Runner Dia @ Head, Design, Runner Length, Runner Flow Coef, Runner Taper) are now disabled and filled with typical values. A callout box points to the 'Typical Street Dual Plane' option in the dropdown with the text: 'If you choose of of the "Typical" Types, the manifold specs are disabled (displayed in gray and you can not change them) and filled in by the program.'

Figure A52 Asymmetric Cam Profiles

Cam/Valve Train Specs for: LATE-MOD.EL

Cam Profile	Intake Profile	Exhaust Profile
Centerline, deg ATDC	106	106.0
Duration @ .050 "	254.0	262.0
Open @ .050 "	21 BTDC	57 BBDC
Close @ .050 "	53 ABDC	25 ATDC
Max Lobe Lift, in	.3493 Clc	.3573 Clc
Actual Valve Lash, in	.018	.02
Designed Valve Lash, in	.018	.018
Rocker Arm Ratio	1.5	1.5
Lifter (profile) Type	Aggr Solid Flat	Aggr Solid Flat
Asymetry, deg	30	0
Gross Valve Lift, in	.524	.536
Dwell Over Nose	0 Deg-Std Profile	0 Deg-Std Profile
Duration @ .200"	160.6	167.5
Use a Cam File	<input type="checkbox"/> Yes	<input type="checkbox"/> Yes

Overall Cam Specs

Total Cam Advance: 0 Straight Up
Lobe Separation, cam deg: 106.0
Lift for Rating Events: .050 inches

Calculate Valve Train Dynamics
 Yes No See Specs for Dynamics

Variable Valve Timing (VVT)
 On Off

Enter the amount of Asymmetry here. Here, 30 degrees means the actual centerline based on peak lift will occur 30 degrees earlier than the centerline based on the opening and closing points at .050" lift. If the actual peak occurs *later* (which is somewhat unusual), you would enter a negative (-) number

OK Help Retrieve from Library Save to Library Print

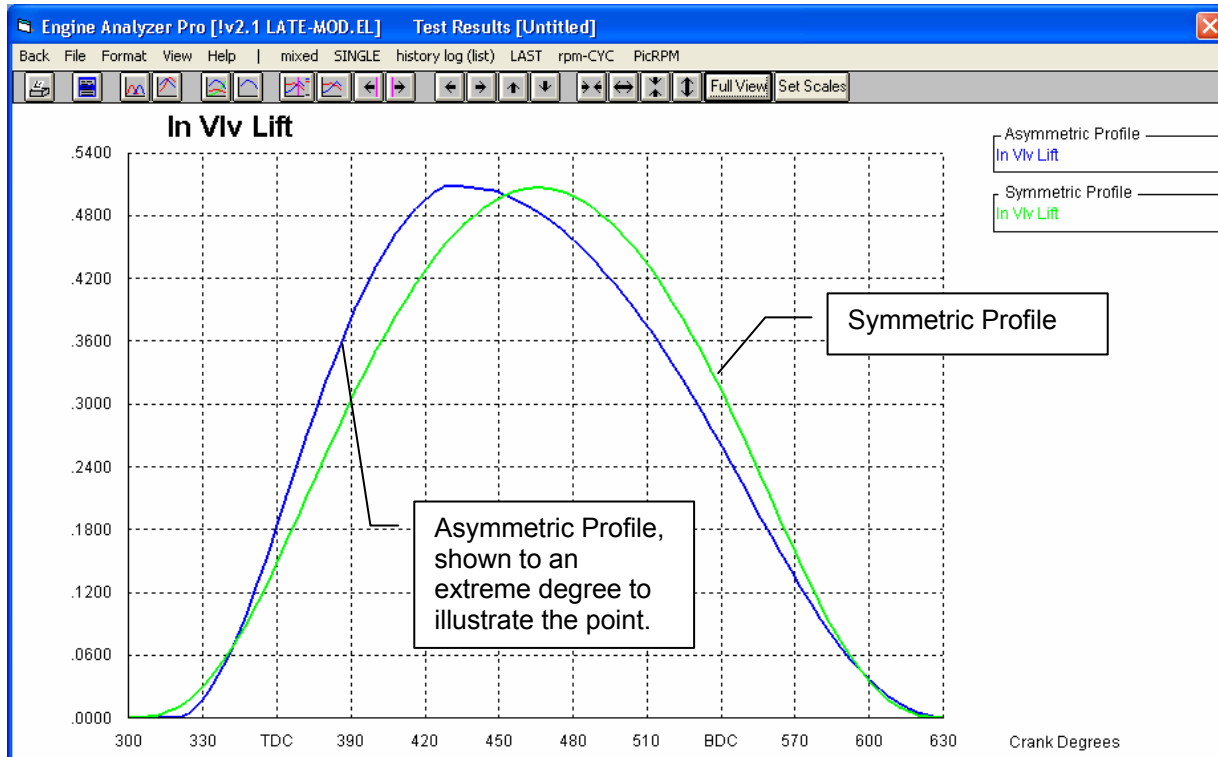
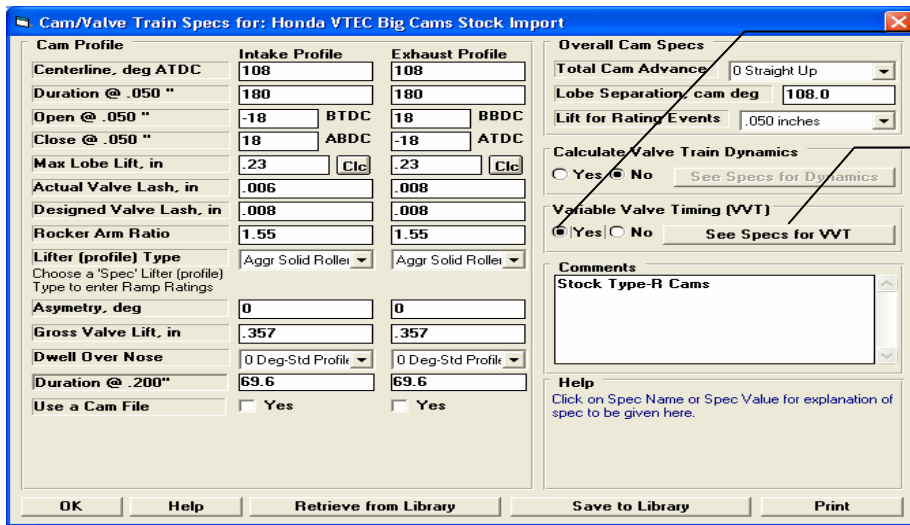
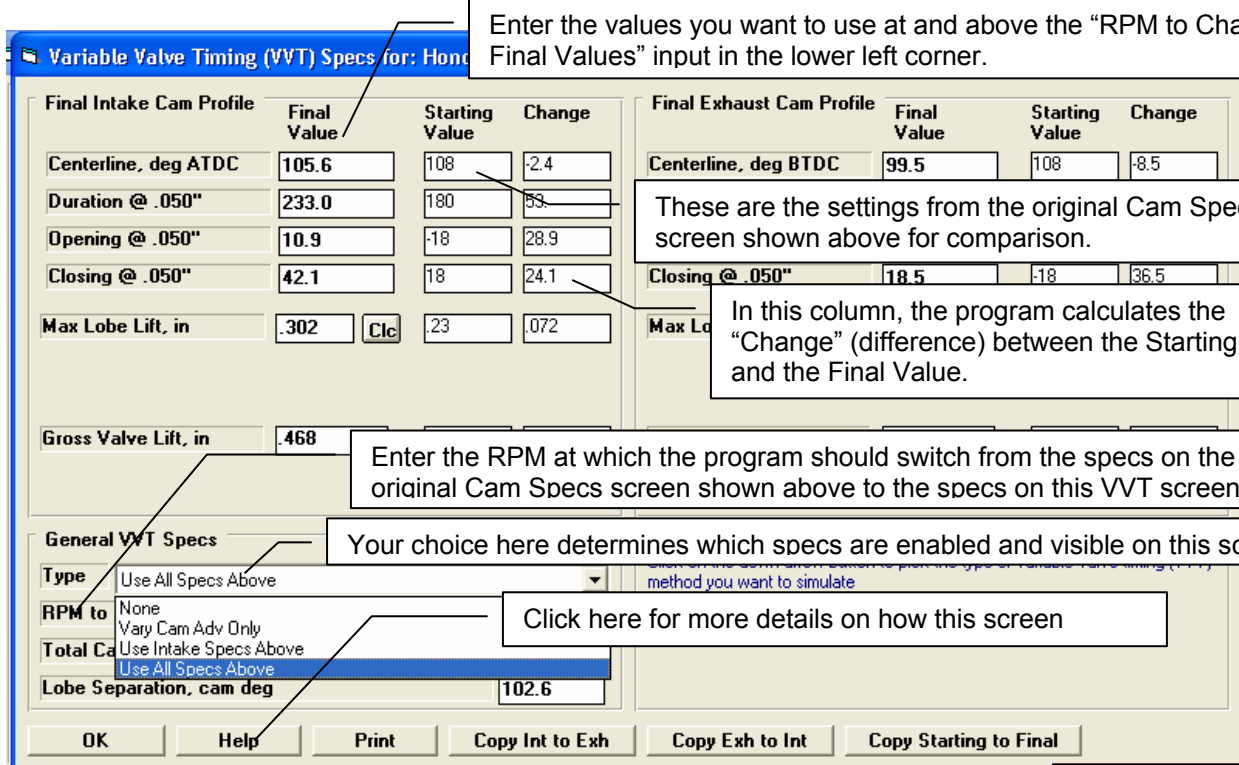

Figure A53 Variable Valve Timing (VVT) Feature



Set to Yes to enable Variable Valve Timing (VVT) specs.

Once enabled, click on the See Specs for VVT button to bring up screen shown below.



Enter the values you want to use at and above the "RPM to Change to Final Values" input in the lower left corner.

These are the settings from the original Cam Specs screen shown above for comparison.

In this column, the program calculates the "Change" (difference) between the Starting Value and the Final Value.

Enter the RPM at which the program should switch from the specs on the original Cam Specs screen shown above to the specs on this VVT screen.

Your choice here determines which specs are enabled and visible on this screen.

Click here for more details on how this screen

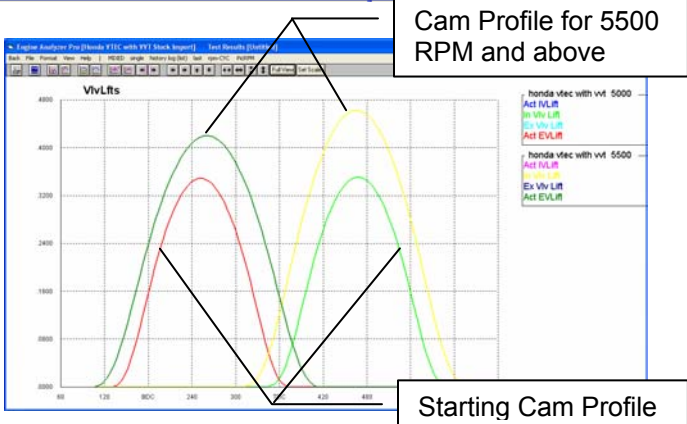
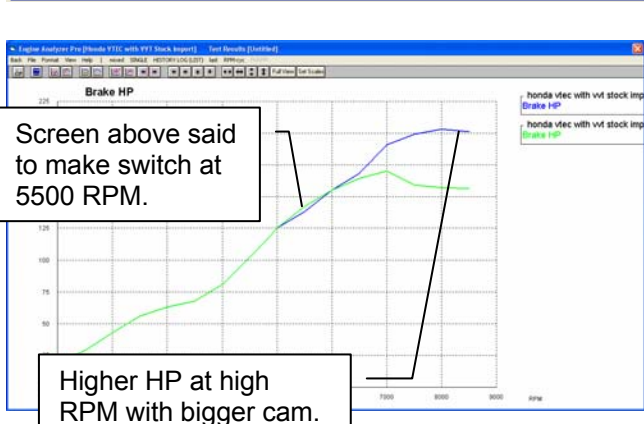

Figure A54 Importing an "Other Format Head File"

Parameter	Current Setting	New Setting
Intake Summary		1.780 dia valve, 223.0 CFM/.600 lift @ 28.0"
Exhaust Summary		1.450 dia valve, 196.0 CFM/.600 lift @ 28.0"
Intake Port Volume	102.0	180.0
Intake Port Diameter	1.78	2.37
Intake Port Length	2.5	2.5
Exhaust Port Volume	77.9	67.0
Exhaust Port Diameter	1.74	1.61
Exhaust Port Length	2	2
Material	Aluminum	Aluminum

Figure A55 Using the "Load Other Format Files" for Cam Files Feature

At bottom of Cam/Valve Train screen, click on Retrieve from Library and select one of the first two "Open.." options to bring up screen to lower left.

1) Find the CamFiles (.CAM) folder on your computer and click on it.

2) Pick the Engine Family of Cams you want to import.

3) Click on the Create button, to add a Category of Example Cams, as shown below.

These cams are full Engine Analyzer Pro format cam files.

Click here to bring up the "Loading Desktop Dyno Cams" screen shown to the right.

1) Find the 'CamFiles (.CAM)' folder containing the Cam Info you want to import.
2) Choose the Engine Family for the Cams.
3) Click on the 'Create...' button. The program will import the data and create a new 'Std Engine Analyzer Example' containing this info.

Std Engine Analyzer Cam Ex
This option loads in HUNDREDS of Cam specs from our std. Engine Analyzer Library.

The program will find all cam files for the particular Engine Family you chose from all the sub folders under the CamFiles (.cam) folder you found on your computer (or most anywhere you can browse to on your computer like a network location, memory stick, etc.)

It will then create a Category in the Std Engine Analyzer examples, where you can compare and pick from all these cams. You can also use all features available to Std Engine Analyzer examples, as outlined in Figure A44.

Highlight this new Category under "Examples Added by User" and click on Use Category to view all these imported cams.

Categories (groups) of Performance Trends' Examples

- Typical Cams
- American Motors 6 Cyl
- American Motors V-8
- Buick V-6
- Buick V-8
- Buick - Other Engines
- Cadillac
- Small Block Chevy
- Big Block Chevy
- Chevy 4 Cyl
- Chevy Inline 6 Cyl
- Chevy V-6
- Other Chevy V-8s
- Chevy Corvair
- Chevy Gen III LS V-8
- Comp Cams All Mopar
- Crane All Mopar

Categories (groups) of Examples Added by User

- Kevin
- DynoSim AMC
- DynoSim Chevy LS V8**

New Category Name

Add New Category Name to List

Rename Chosen Category

Delete Chosen Category

See page 118 in manual for details.

Use Category Cancel

Tip: Click on a Category in either section to highlight it, then click on the 'Use Category' button, or just Double Click on the Category to pick in one step. (Categories are groups of examples, like a group of Chevy heads, not individual examples.)

Figure A56 Importing a Cam File from Cam Analyzer

At bottom of Cam/Valve Train screen, click on Retrieve from Library and select one of the first two "Open.." options to bring up screen to lower left. The Open Cam Analyzer File option will appear once you've opened a Cam Analyzer file via this

- Open Example from Performance Trends
- Open from My Saved Files
- Open Std Engine Analyzer Example
- Open Std EA 'Chevy Corvair' Cams
- Open Cam Analyzer File

At the Retrieve screen click on Load from Cam Analyzer to bring up the screen to the right.

For the Pro to find the Cam Analyzer (and for this button to be visible), you must set up Cam Analyzer in the Preferences screen under the Reading Data Files tab

Tip: Single click on an engine name to 'choose it' for possible Opening or Deleting. A 'preview' of that engine will be given in this frame. Double click on an engine name to immediately Open it without a preview.

Show Only Files which contain this phrase: [reverses] Show All Files

Std Engine Analyzer Cam Examples Load from Cam Analyzer Load Other Format Files

This option loads in HUNDREDS of simple Cam specs from our std. Engine Analyzer's Library. Click on button above for info on loading other cam file formats. This option lets you load files from other company's programs.

12 Tests in Library

- CC8094-S.R04
- Example Circle Track Cam.PTI
- Example Drag Cam.PTI
- Ex-CamPP.cpp
- Ford 427 SOHC/Left
- Honda CRF450
- Quick Check - BB Chevy
- Quick Check - Most Engines
- SAINTY 1.CYL
- SB Chevy on Stand
- SB Ford on Stand
- UD6060-S.R07

List All Files by File Name
 List by File Name (include Head #)
 List by Head # (include File Name)

Open Cancel Help

Folders: examples, Harley Davidson for .053 Lift Point, my-tests, oldfiles

Tip: Click on a different Folder name to display all the tests saved under that Folder Name

Ron Jackson's 350 CID Chevy - Cast Iron Heads
 Int=260 @.050/.435 Exh=260 @.050/.435 are specs

Cam Profile	Intake Profile	Exhaust Profile
Centerline, deg ATDC	101.1	111.4
Actual Valve Lash, in	.02	.022
Rocker Arm Ratio	1.6	1.6
Lifter (profile) Type	Aggr Solid Roller	Aggr Solid Roller
Duration @ .200"	n/a for cam file	n/a for cam file
Use a Cam File	<input checked="" type="checkbox"/> Yes	<input checked="" type="checkbox"/> Yes
Cam File	UD6060-S.R07 Int	UD6060-S.R07 Exh

Pick Intake Pick Exhaust

OK Help Retrieve from Library Save to Library Print

Back at the Cam/Valve Train specs screen, you will see this cam file name (slightly modified with "Int" or "Exh") being used for both lobes. The Cam Analyzer program puts them in the Engine Analyzer Pro's "CamFiles" folder, the default location for the Pro's cam files. Other specs like Lash, Rocker Ratio, Centerline, Comments, etc are also carried over to the Pro, so the Pro should be reading the file exactly as you entered it or measured it in the Cam Analyzer.

What the Cam Analyzer program has done is created 2 files in Comp Cams™ format, adding "Int" and "Exh" to the name and storing them in the CamFiles folder. Raw Cam Analyzer format is too complicated and may not include all modifications you have made (like virtual follower, timing changes, etc) and that is why the Cam Analyzer writes them in the much simpler Comp Cams™ format.

Appendix 12: New Features in v 3.9 B

Engine Analyzer Pro v3.9 B has many updates, new example engine files and component files, and improved features. Here is a listing of the features new since v3.9 A was released.

New Features:

You can now link your engine file to a picture file. This picture appears on main screen and adjusts to fit the available screen. This picture file can also be included in printouts of graphs and reports. Fig A57-A58.

You can now do Chain Calculations on Opening and Closing Cam Events.

Program now has a Graph on the Cam Specs screen to give you an idea of the shape of the valve lift curves, this graph is updated with each change you make to the inputs. You can also click the graph lines in the Cam/Valve Train specs screen and the data at that point are displayed at the bottom of the graph. Fig A59.

The program has several new features for outputting reports as ASCII text files. Fig A60. These files are useful for using results in other programs like Microsoft Excel™. These features include:

- Option for exporting as simple text (.txt) or files more compatible with Excel, like comma separated (.csv).
- There is a new Browse button for creating names locating where the files are written.
- There's a new option for outputting the data as either Rows or Columns.
- There's a new field where you can enter several comments which will appear at the bottom of the ASCII file.

When opening a Total Engine File, there is a new "Compare" button. If you click on a file name (but not open it), you can click this button and see what modifications have been done to a particular file compared to the file you are currently working with. Fig A61.

Printed graphs have a new layout which eliminates the left side border which could appear "broken" on some printers.

When sending files to vehicle programs, there is a new Browse button for looking for files and programs.

The program now sends files you delete to the Recycle Bin instead of permanently deleting them. This allows you to recover them from the Recycle bin if you made a mistake.

The program now works better if you are pressing the <> and >< buttons on graph to change scales or after changing scales you go to print the graph.

There is a new option on the Graph screen under File called "Email Graph Printout as PDF" file.

The program now has many enhancements for Email Preferences for more modern email servers. Fig A62-A63.

The program has a new "Convert" option to be able to modify the CFM entries on the screen for entering detailed turbo map data. This allows the user to enter data in various units, and then convert the flow data to CFM or increase or reduce the data by a particular factor. Enterprise Edition only.

The input grid on the screen for detailed turbo or centrifugal map screen will now enlarge better if the screen is enlarged. This makes it much easier to read the grid. Also, now clicking on the Turbo or Cent SC Map will highlight the cell at the point you clicked on the map. Enterprise Edition only.

You can now load a .jpg image of a compressor map for more efficient and accurate "translating" its data into an Engine Analyzer Pro compressor map file. Enterprise Edition only.

New Inputs:

The Enterprise Edition has a completely new input screen called Valve Spring Dynamics. Here you can describe 1, 2 or 3 valve springs for Intake and Exhaust and the program will evaluate how they will work with a particular valve train. New graph options let you watch how well controlled the coils behave, and if you are likely to have valve spring surge. With valve spring dynamics On, the program will also simulate valve bounce on the seat and how that valve bounce re-opens a valve and could

affect power. Note: For this first version, the units in this screen are always in English units. Files you create in Engine Analyzer Pro are saved in the Users Spring Files folder.

The program now has 2 more types of Roots Supercharger Types to pick from, “Modern” and “Modern 2000+”. The original Roots Supercharger type (now called “Standard”) is for an old style GMC blower, like a “671”. The new types represent superchargers installed on production supercharged cars like modern Mustangs and Corvettes. Fig A64.

The program now allows for a “ramp” (gradual) change in valve duration, timing and lift when simulating VVT (variable valve timing). Fig A68.

The program will now read a “.p” file format of cam file.

Valve Spring “Compression to Bind” is a new input in the Valve *Train* Dynamics screen and the Valve *Spring* Dynamics screen. The program also considers this bind travel when doing valve train dynamics calculations for improved valve train simulation accuracy. There is also a new “Clc” calculation utility screen for calculating this travel. Fig A65.

There are now more Std Engine Analyzer example cams supplied with 'the Pro were available, mostly Comp Cams BB and SB Chevy.

In Head Specs, there is a new choice for Chamber Designs which are for modern Direct Injection. Fig A66.

Program now lets you select which ports to use for importing tests from the Port Flow Analyzer program. Fig A67.

We’ve added several new Example Total Engine Files, component files like Complete Heads, and full compressor maps for both turbos and centrifugal superchargers.

You can now use KG for force for calculating spring force and rate for valve train dynamics in 'Clc' screen.

There’s a new Preference called "Valve Lift at TDC Assumes 0 Lash" under the Calculations tab. The Valve Lift @ TDC is shown in the Special Calculations section of the results. If you choose Yes for this, the program assumes there is NO LASH when checking this lift, like if checking with a light duty test spring. If you choose No, the program assumes there is the lash the program used for performance calculations. For Hydraulic lifters, this is typically assumed to be .006" lash, or compliance.

New Outputs:

When doing Valve Spring Dynamics, the program has new Graph Options for graphing the valve spring motion, and an “animation” screen to visualize the valve spring motion. Enterprise Edition only.

If you choose a Cam File for the cam profile in the Cam/Valve Train specs screen, the program now checks the Max Valve Lift for the cam file, and displays it on the screen.

There is a new Preference to allow you to pick of number of decimal places for RPM data to be reported.

Printouts now show proper units for Engine Input Specs in either Inches or MM, depending on your choice of units in Preferences.

Bind Clearance now displayed in the Special Calculations section of the Report Screen after calculating performance. Bind Clearances is calculated from peak valve lift from the cam specs and the new input Valve Spring “Compression to Bind”.

The Special Calculations section at the bottom of results now are shown in mm instead of inches where appropriate.

Accuracy:

The program considers the new input of Valve Spring “Compression to Bind” when doing valve train dynamics calculations for improved valve train simulation accuracy.

The new Roots Supercharger types will greatly improve accuracy of simulating modern positive displacement (roots type) superchargers. See New Inputs section.

The program has refined its simulation of plenum volume for race EFI and tunnel ram intake manifolds.

There has been some refining of the Knock Index calculation. This does not affect performance calculations.

Figure A57 Picture File Features

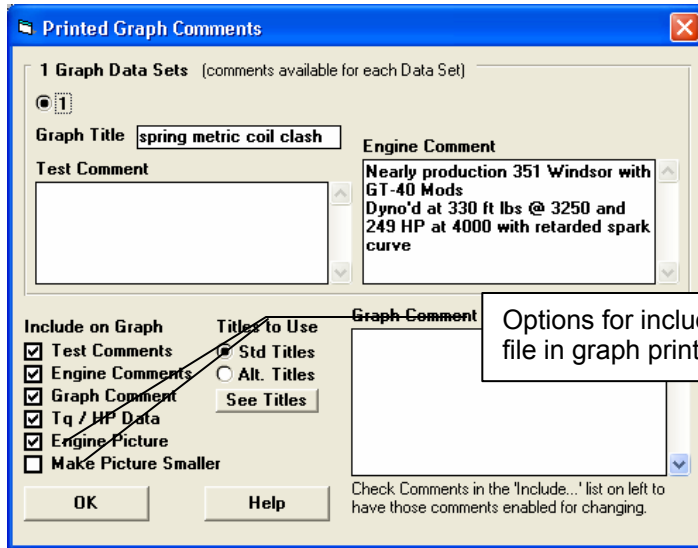
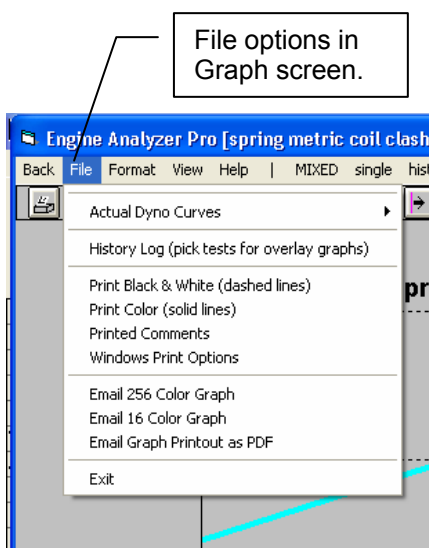
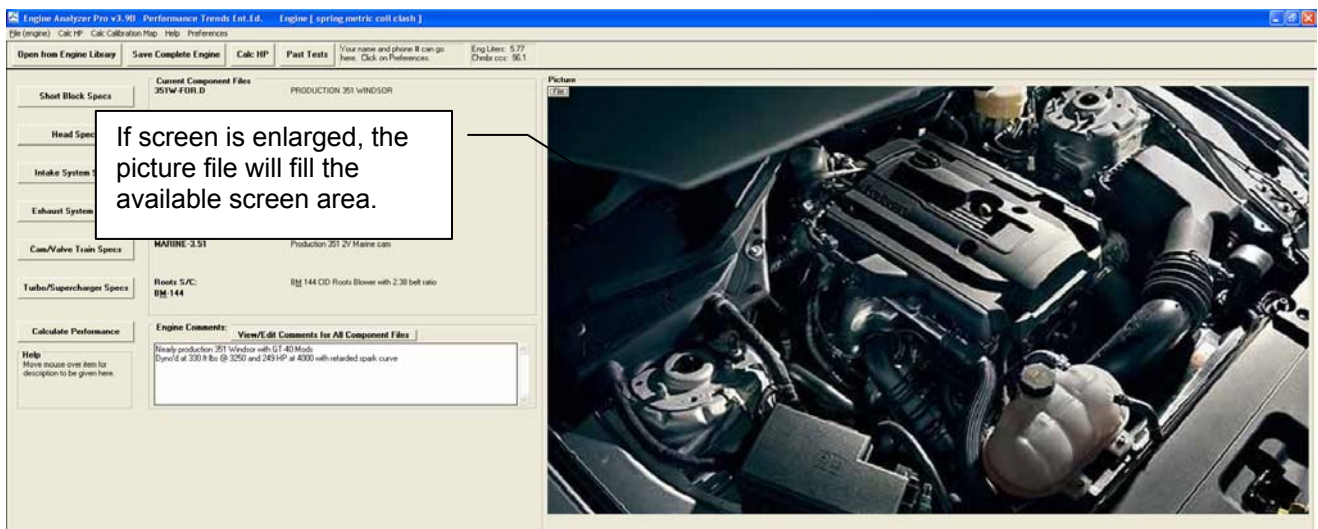
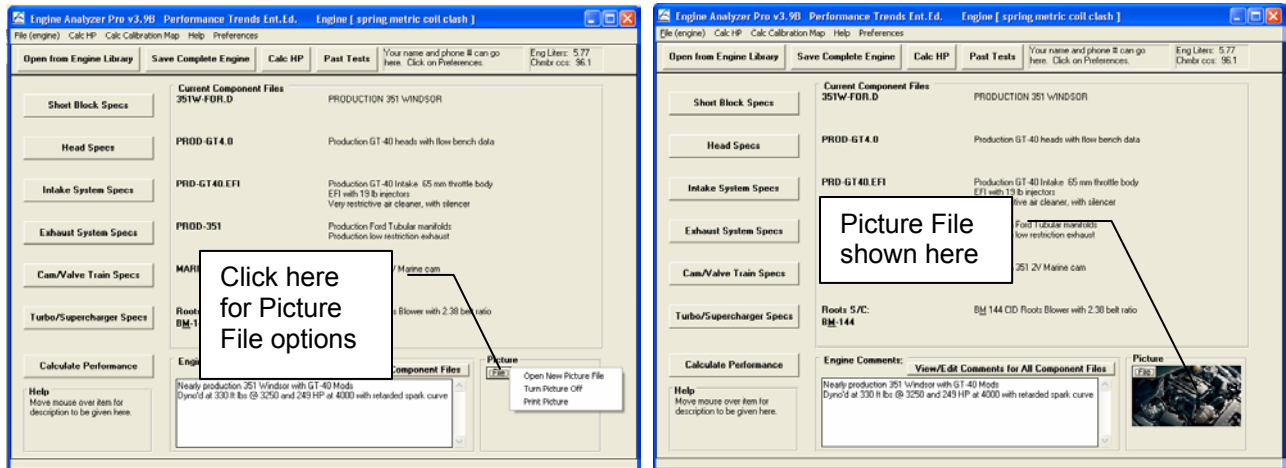

Figure A58 Picture File Features, cont

Engine Analyzer Pro v3.9 B
Eng: spring metric coil clash
Calculated Test Results

Your name and phone # can go here. Click on Preferences.
Performance Trends (C) 2009

This Graph Printed:
10:15 am 08-14-16
Page: 0

Printing picture normal

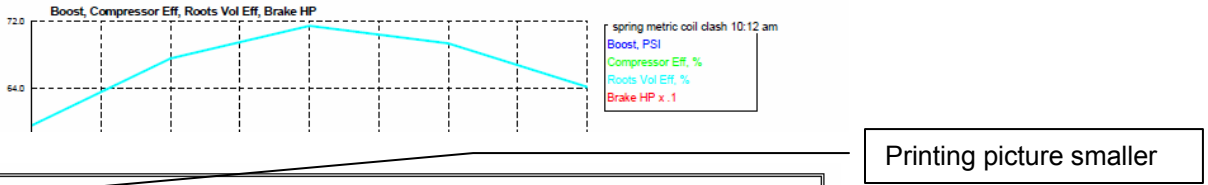

Engine Analyzer Pro v3.9 B
Eng: spring metric coil clash
Calculated Test Results

Your name and phone # can go here. Click on Preferences.
Performance Trends (C) 2009

This Graph Printed:
10:16 am 08-14-16
Page: 0

Printing picture smaller

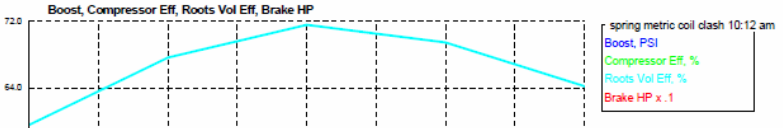

Printout Options

Report Printing Options

- Include Engine Specs
- Include Engine Comments
- Request Report Comment
- Dot Matrix Printer Adjustment
- Include Special Calcs
- Include Engine Picture
- Small Picture (if portrait)
- Email as PDF (tm) File
- Email as Text File

Print Report Using These Specs

Other Printout Types

- Print Blank Worksheet
- Print Definitions of Outputs

Cancel

Tip
See page 145 in manual for more info.

Printing picture file in reports

Printing picture file smaller in Reports

Engine Analyzer Pro v3.9 B
Eng: spring metric coil clash
Calculated Test Results

Your name and phone # can go here. Click on Preferences.
Performance Trends (C) 2009

This Report Printed:
10:17:45 am 08-14-16
Page: 1

Engine Comments:
Nearly production 351 Windsor with GT-40 Mods
Dyno'd at 330 ft lbs @ 3250 and 249 HP at 4000 with retarded spark curve

Projected Performance

Engine RPM	2000	3000	4000	5000	6000
Brk Tq, ft-lbs	415	464	462	398	303
Brake HP	158	265	351	379	346
Exh Pres, PSI	.7	1.9	3.5	4.8	5.7
Boost, PSI	9.76	11.60	12.30	13.73	17.78
Vol Eff, %	112.6	126.1	131.4	125.4	114.7
Actual CFM	229	385	535	638	701
Fuel Flow, lb/hr	80.1	134.5	186.9	222.9	244.7
Nitrous lb/hr	00	00	00	00	00

Figure A59 Graph in Cam Specs Screen

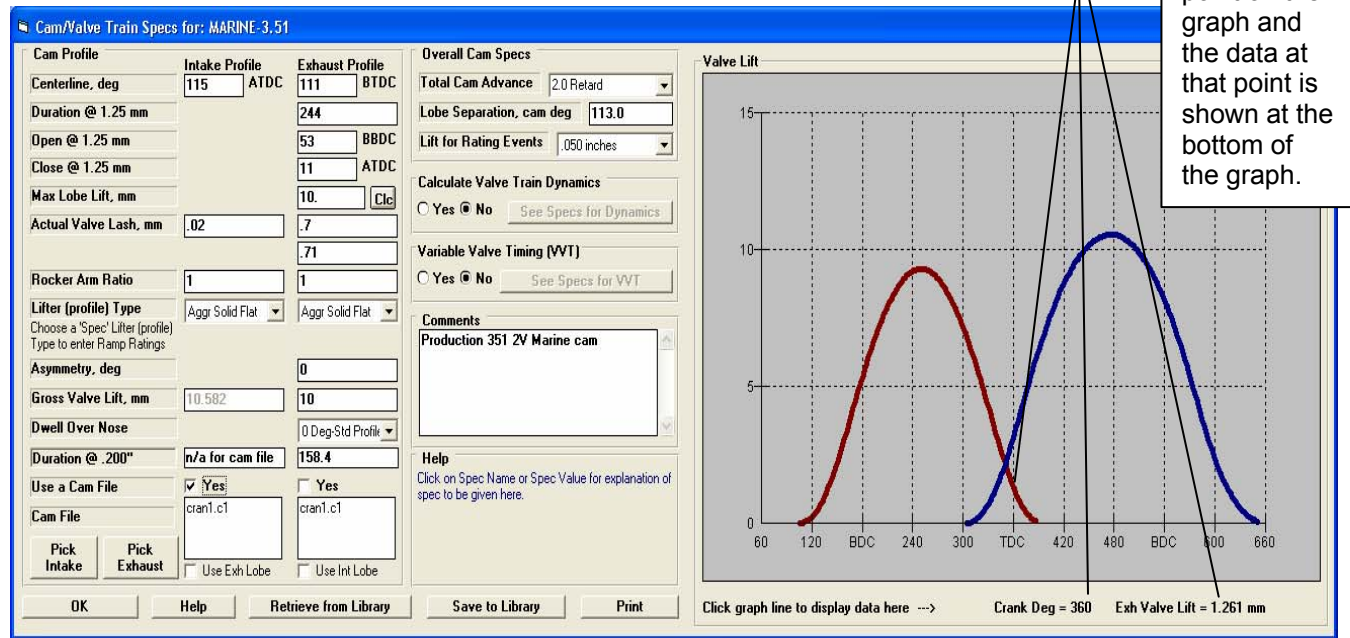

Figure A60 New ASCII File Features

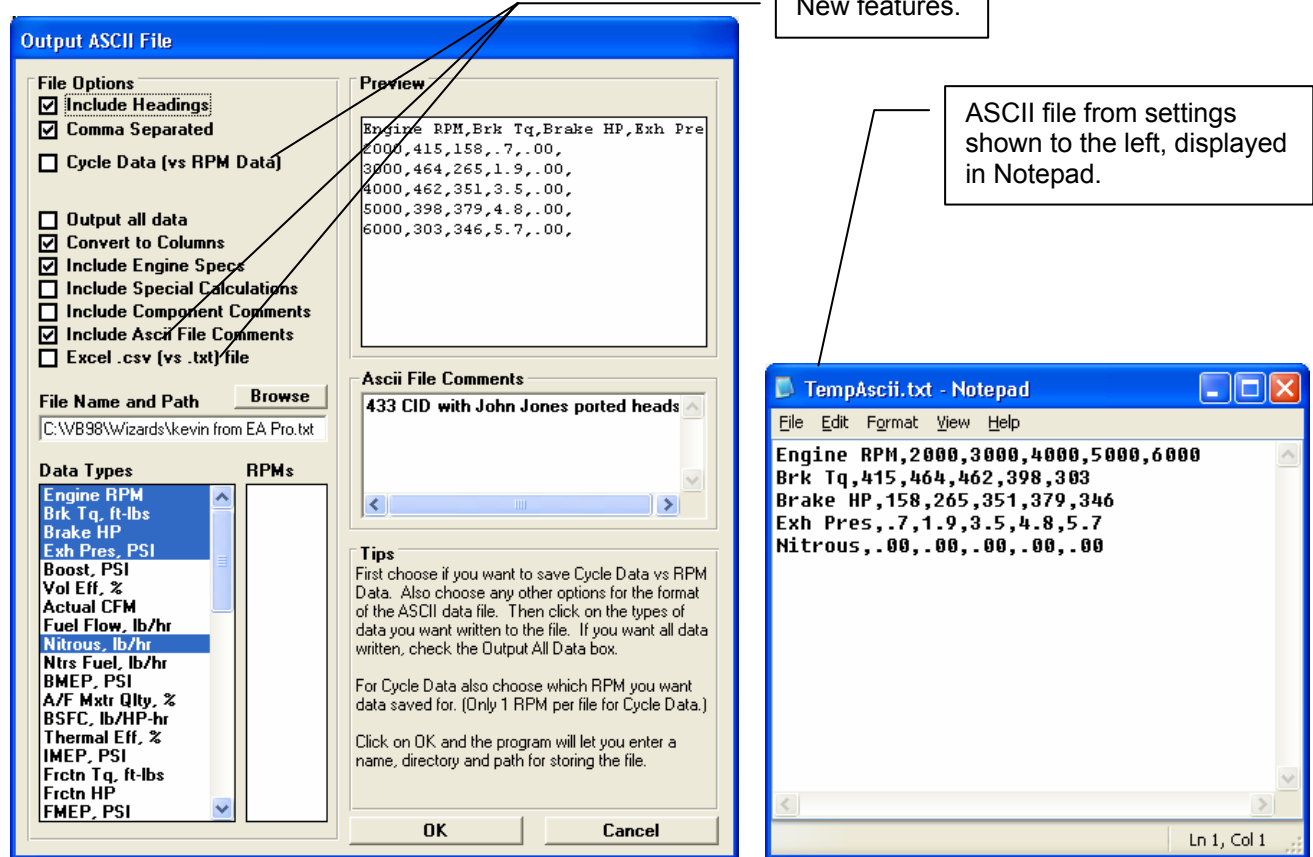
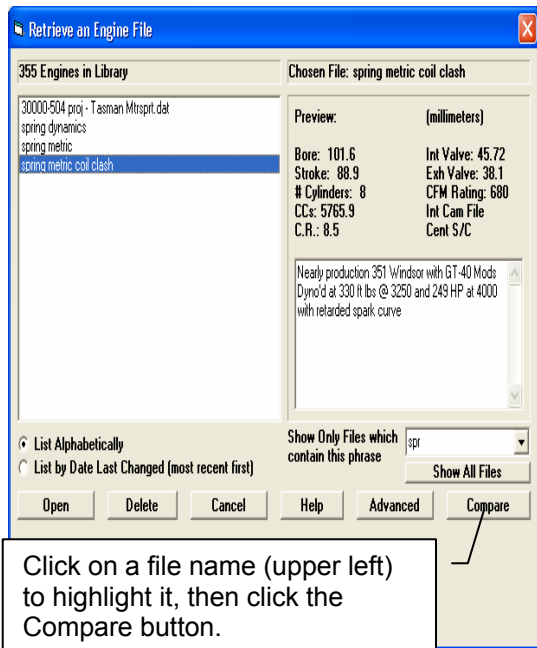
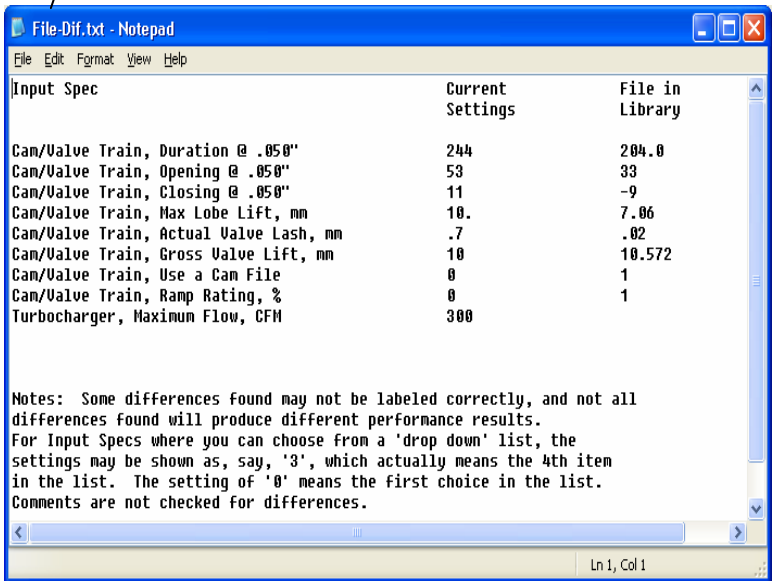

Figure A61 File Compare Feature



The program will display the differences found between the file highlighted and the current settings for the engine in the program now.



Click on a file name (upper left) to highlight it, then click the Compare button.

Figure A62 New Emailing Preferences

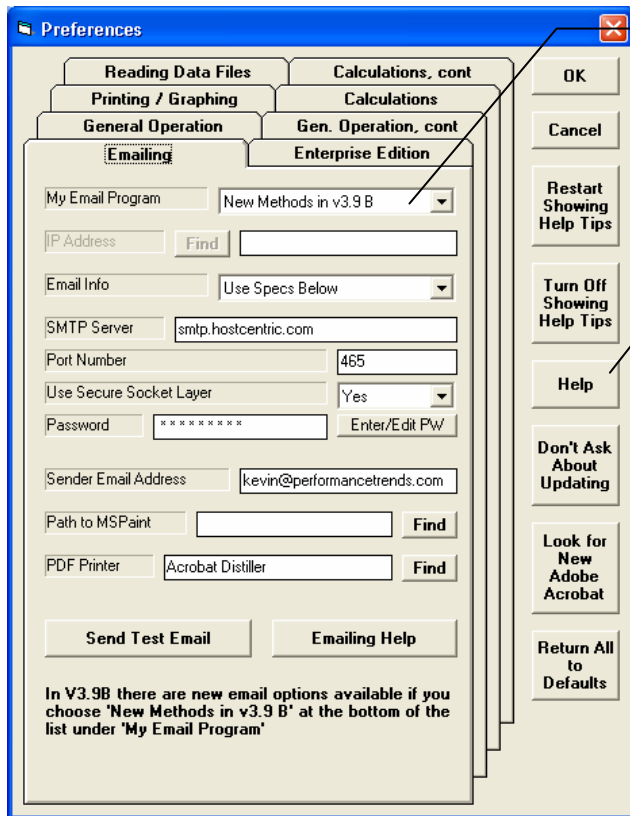

Choose this option "New Methods in v3.9B" and several new inputs are enabled. The new inputs allow the EA Pro to email from newer email services like gmail, hotmail, etc.

Click this Help button for more info on the new Email Inputs.

Figure A63 New Emailing Features for Reports and Graphs

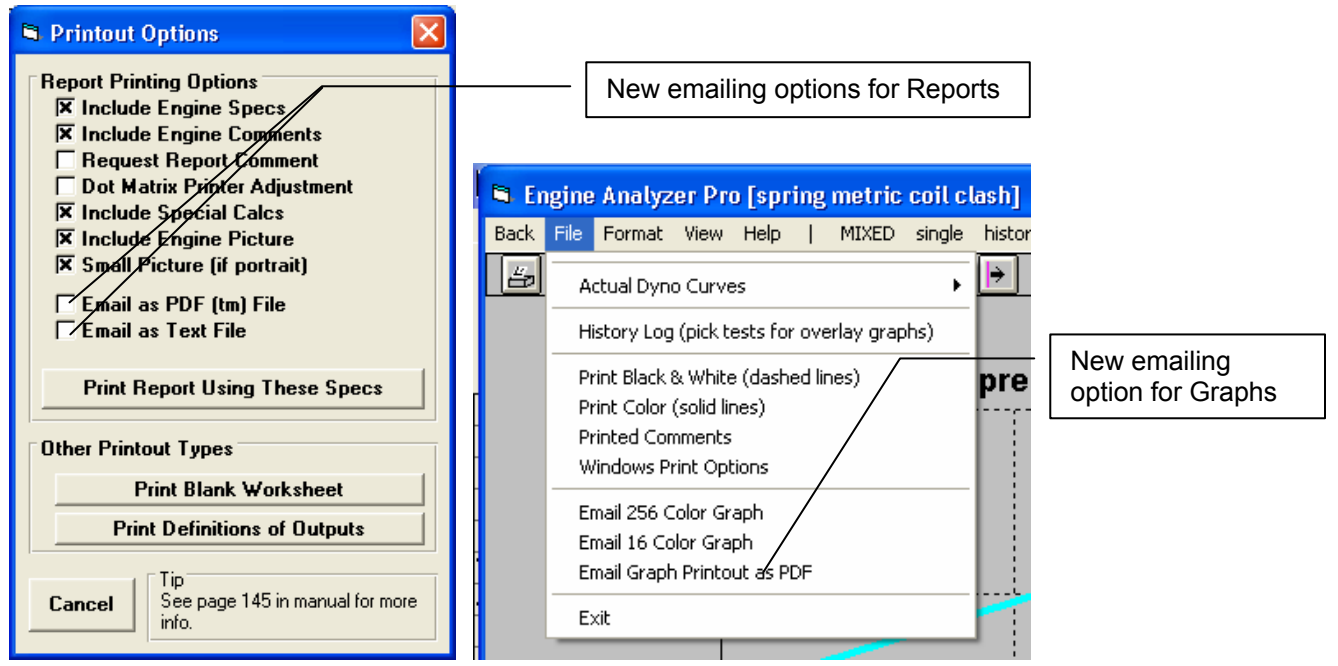

Figure A64 New Roots Supercharger Types

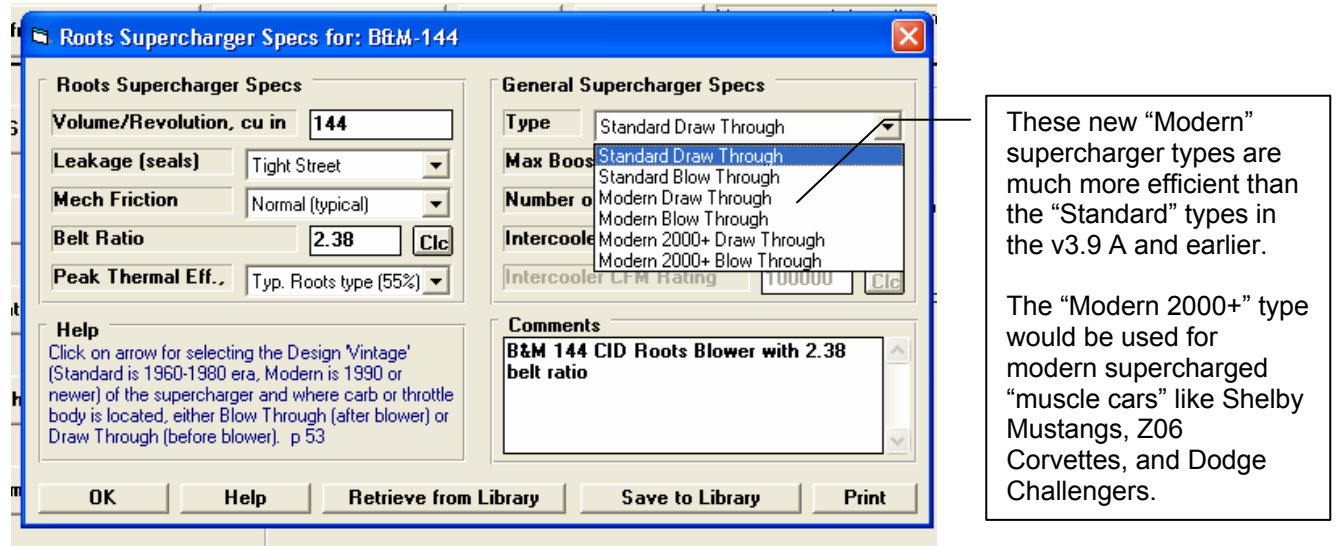

Figure A65 Valve Spring "Compression to Bind"

The image shows two software windows. The main window is titled "Valve Train Dynamics Specs for: MARINE-3.51". It is divided into two columns: "Intake Valve Train Specs" and "Exhaust Valve Train Specs". Each column contains several input fields with numerical values and "Clc" buttons. The "Compression to Bind, mm" field in the Intake section is highlighted with a callout box that says "New 'Compression to Bind'". Below the input fields are "Comments" and "Help" sections. At the bottom are buttons for "OK", "Help", "Print", "Detailed Spring Table", and "Simple Spring Table".

The second window is titled "Calc Comp. to Bind". It has a "Calc Comp. to Bind" input field with the value "11.". Below it is a "Spring Specs" section with "Bind Height, mm" (18) and "Seated Height, mm" (29). A "Notes" section contains text: "This calculation determines how much the spring can compress from seated height before coil bind." At the bottom are buttons for "Use Calc Value", "Help", "Cancel", and "Print".

Figure A66 New Direct Injection Input

The image shows a software window titled "Cylinder Head Specs for: PROD-GT4.0". It is divided into four main sections: "Intake Port Specs", "Exhaust Port Specs", "Combustion Chamber", and "Miscellaneous". The "Combustion Chamber" section has a "Chamber Design, # Plugs, Direct Injection" dropdown menu. The list of options includes "Typical Wedge", "Dual Plug Hemi", "Dual Plug Flathead", "Dual Plug Pent Roof", "Typical Wedge-Direct Inj", "Compact Wedge-Direct Inj", "Hemi-Direct Inj", "Flathead (side valve)-Direct Inj", and "Pent Roof-Direct Inj". A callout box points to this list with the text: "The bottom half of this list now lets you pick Direct Injection, which means fuel is injected directly into the chamber after the intake valve has closed. This is similar to a diesel engine, but for gasoline engines. Only the most modern engines would have this type of fuel delivery." At the bottom are buttons for "OK", "Help", "See Layout", "Retrieve from Library", "Save to Library", "Print", and "Angles".

Figure A67 Picking Which Ports to Import from Port Flow Analyzer

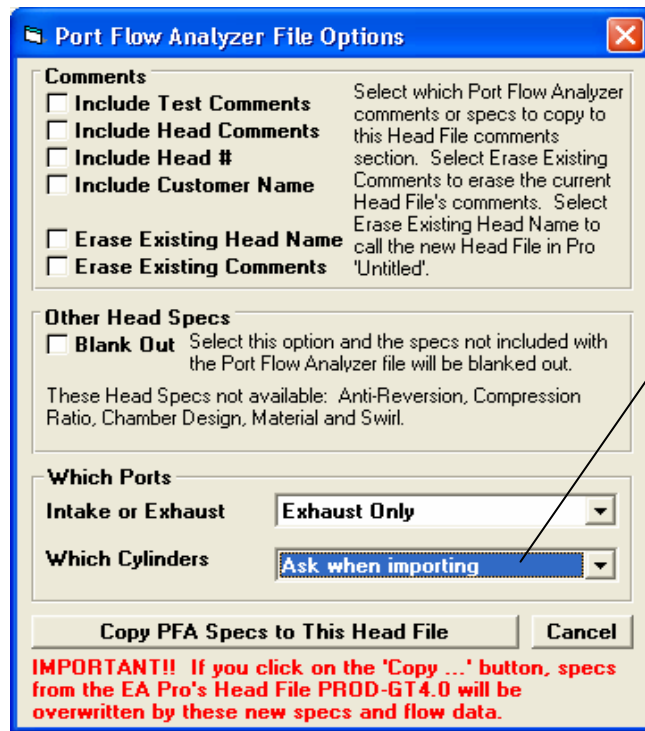

New option to allow picking which port's data to import. Prior to this, the data was averaged across all cylinders for a particular head.

Figure A68 Ramp Change for Variable Valve Timing Feature

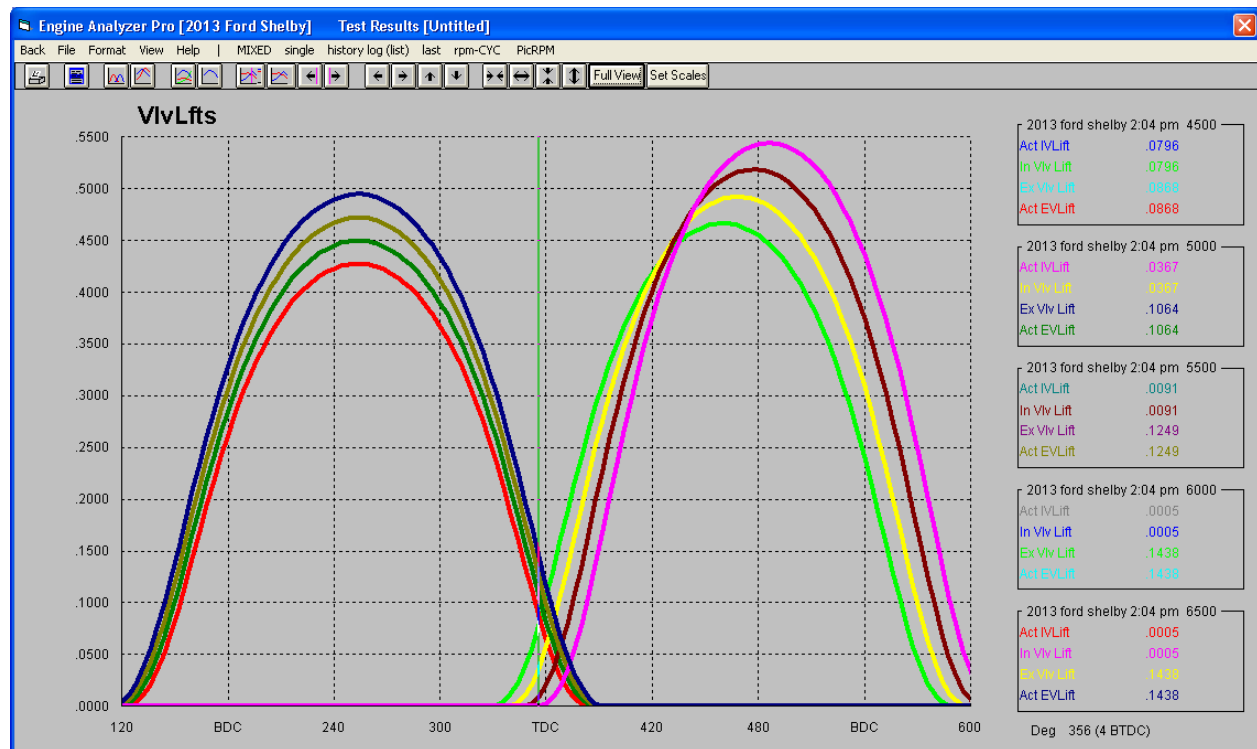

Appendix 13: New Features in v 3.9 (A & B) Enterprise Edition

The Enterprise Edition of Engine Analyzer Pro has some very advanced features the typical user would not use. These include:

- You can use a full compressor map to define the performance of a turbocharger compressor. Figs A70 and A71.
- You can specify a particular turbocharger boost level, intake manifold temperature (after the turbocharger compressor), and exhaust backpressure level. This gives you more freedom to simulate some particular situation which may be difficult to simulate using the turbocharger compressor and turbine model specs in the program. Fig A72.
- You can view the compressor map when calculations are being performed to see what area of the map is being used. Fig A73.
- You can use a full compressor map to define the performance of a centrifugal supercharger compressor. Figs A74 and A75.
- You can design a system where a centrifugal supercharger feeds into a roots blower supercharger. Fig A76.
- You can interface to the Compression Ratio Calculator program and transfer data back and forth between them. Figs A77 through A80.
- You can run a part throttle performance “map”. This map can be useful for calibrating electronic engine controllers, or just understanding part throttle performance. Fig A81 and A82.
- There is a new Preference which lets you choose a different language for certain labels in the program. Fig A83.
- Two new Preferences are provided to adjust the valve train dynamics calculations. One allows you to increase the stiffness of the lifter/cam interface. The other allows you to increase the stiffness of the rocker arm for Overhead Rocker Arm styles of valve trains. The factor you pick is multiplied by the default stiffness. For example, if you pick 1.5, the default stiffness is increased 50%. Fig A83.
- A Preference has been added to allow for adjusting intake runner wall friction for the Intake Runner and Port. The program picks a certain amount of wall friction based on manifold type, Runner Flow Coef, etc. Your choice here will change it by the percentage you pick. Fig A83.
- A Preference has been added to let you adjust how much valve toss (separation between follower and cam) will be called Valve Toss in the tabular results. The default used by the program for many years is .020”. If the program sees more than .020” separation between cam lobe and follower, it is flagged as Valve Toss in the calculated results. Your choices will let you pick a certain percentage of the lobe’s maximum lift. Fig A83.

New Features in v3.9 B

New features added in v3.9 B include:

You can now import a .jpg graphics file of a turbo map to assist in translating the data from the .jpg file into the tabular data required by the program. Fig A84 – A86.

Additional features have been added to the Compressor Map screen to allow for easier entering and editing of data. Fig A87.

You can now enter details about the valve springs to simulate valve spring dynamics. These inputs are very similar to the inputs used in Performance Trends’ Spring Wiz program. Check out our Spring Wiz program for more info on the specifications used for the Valve Spring Dynamics inputs. (At this time, the inputs on this screen must be entered in English units.)

Figure A70 Using a Full Compressor Map for Turbochargers

Turbocharger Specs for: RAJAY-30.0F

1st Stage Turbocharger Specs

Surge CFM: 180
Exh Turbine Eff. %: 65% Typical
Turbine Nozzle Dia, in: 1.1

General Turbocharger Specs

Throttle Location: Draw Through
Max Boost Limit, PSI: 10
Turbos/Stages: 1 Single Turbo
Intercooler Eff. %: 0% No Intercooler
Intercooler CFM Rating: 100000
Wastegate Is...: Before Intercooler

Force to Boost Conditions

Boost, psi: [] Int Temp: [] Exh Pres: []
Force These Conditions: No

Full Compressor Map

Use Compressor Map: Yes File: @C:\WB98\projects6\EAPROX\CENTMAP\Gar View

Help

CFM where the surge line intersects pressure ratio of 2.0. p 59

Note that some specs are not needed when you choose to use a Map.

Current Map File Name

Click on View for screen below, to enter, open or edit Map settings.

Set to Yes and then you can choose a Map File to describe the turbocharger compressor.

S/C Map [Garrett GT1241 50 Trim.CMP]

Pressure Ratio Range (rows)

Highest Pressure Ratio: 5.00
Pres. Ratio Step Size: 0.125
Preview: 1.00, 1.13, 1.25, ... 5.00

CFM Flow Range (columns)

Highest CFM: 290
CFM Step Size: 14.524
Preview: 15, 29, 44, ... 290

Surge CFM: 35
Update Graph
Print Table

Pres Ratio	15	29	44	58	73	87
1.00 Eff%	45	45	50	50	50	50
1.13 Eff%	48	50	55	55	55	55
1.25 Eff%	50	55	60	65	65	62
1.38 Eff%	55	60	65	65	68	68
1.50 Eff%	55	60	65	68	70	73
1.63 Eff%	55	60	65	68	71	74
1.75 Eff%	55	60	65	68	71	74
1.88 Eff%	55	65	65	68	70	74
2.00 Eff%	55	60	65	68	69	72
2.13 Eff%	55	60	65	65	68	72
2.25 Eff%	55	60	65	65	68	72
2.38 Eff%	55	60	65	65	68	71

Choose settings which describe how large the Map will be and how many "cells" you have to fill in for the Map, the smaller the "Step Size", the more cells.

Surge CFM is still used with Map and drawn on Map.

The Graph is not automatically updated with each change you make. Click here to update the graph.

Click on a grid cell to enter the Thermal Efficiency at that Pressure Ratio and CFM flow, then press <Enter> to advance to next cell.

Figure A71 More Compressor Map Features

S/C Map [Garrett GT1241 50 Trim.CMP]

Pressure Ratio Range (rows)
Highest Pressure Ratio: 5.00
Pres. Ratio Step Size: 0.125
Preview: 1.00, 1.13, 1.25, ... 5.00

CFM Flow Range (columns)
Highest CFM: 290
CFM Step Size: 14.524
Preview: 15, 29, 44, ... 290

Surge CFM: 35
Update Graph
Print Table

Pres Ratio	15	29	44	58	73	87
1.00 Eff%	45	45	50	50	50	50
1.13 Eff%	48	50	55	55	55	55
1.25 Eff%	50	55	60	65	65	62
1.38 Eff%	55	60	65	65	68	68
1.50 Eff%	55	60	65	68	70	73
1.63 Eff%	55	60	65	68	71	74
1.75 Eff%	55	60	65	68	71	74
1.88 Eff%	55	65	65	68	70	74
2.00 Eff%	55	60	65	68	69	72
2.13 Eff%	55	60	65	65	68	72
2.25 Eff%	55	60	65	65	68	72
2.38 Eff%	55	60	65	65	68	71

Select a file, then click on Open

- Cent Map Nov 2012.CMP
- Garrett GT1241 50 Trim.CMP
- Garrett GT3582R 56 Trim.CMP
- Turbonetics T04S-60-1.CMP
- Turbonetics T61.CMP

Open This File Cancel Open

OK (keep changes) Cancel Changes Save As (new name) **Open** New (blank out)

Click on a saved Map file, then click on Open This File button to open it. Turbocharger Map files are saved in the CENTMAP folder with a ".CMP" file extension. Centrifugal Supercharger Map files are saved in the same folder with a .CMC extension.

Click this Open button to display the list of saved files shown above.

Click here to save this Map to a new name.

Current Map file name. Note: A Map file is just the specs you see in this screen. It is just a part of the total Turbocharger component file.

Figure A72 User Specified Turbo Boost and Backpressure

Exhaust pressure is typically close to the Boost pressure. In a very efficient, turbo which is well matched to the engine, the exhaust pressure can be less than boost pressure. In an inefficient system, exhaust pressure will be higher. If you are not sure, set this equal to Boost pressure.

Comments
Approximate specs for single Rajay 300F trim with 10 psi limit on wastegate.

Force to Boost Conditions
Boost, psi: 100
Int Temp: 411
Exh Pres: 85
Cld
Force These Conditions: Yes

Help
Enter the Intake Boost Pressure you want the program to force into this intake manifold. The program will produce much more or less boost than this.

Buttons: OK, Help, Retrieve from Library, Save

Calc Intake Temperature

Calc Intake Temperature, Deg F: 411
Outside Air Temperature, Deg F: 77
Barometric Pres, inches HG: 29.66

Intake Conditions
Boost Level, PSI: 100
Turbo Efficiency: 70% Good
Turbo Efficiency, %:
Intercooler: Yes
Intercooler Effectiveness, %: 40

Buttons: Use Calc Value, Help, Cancel, Print

Click on this Cld button for the screen to the left, where you can enter some inputs about the turbo system and get a good estimate of the Intake Air Temperature going into the engine after the turbocharger.

Figure A73 Watching the Compressor Map during Calculations

If you are using a Map file, this button will appear on the Progress Form. If you select to Show S/C Map, you have choices to show continuously or Pause at different steps.

For most situations, "Pause Each RPM" is a good choice.

Click mouse button down on the blue title bars of these small screens and **hold down** to grab these screens. While holding mouse button down, slide mouse to place where you want to see what you need.

Current conditions shown here as numbers and graphed on Map as dot.

Dots are shown for each intermediate step. Note that these dots top out at a pressure ratio of about 2.0 because of the Max Boost setting of 30" in the Turbocharger Specs screen.

At the end of each step, click on these new buttons to advance to the next step, print the Map, or go back to Continuous running.

Engine RPM	2000
Brk Tq, ft-lbs	342.4
Brake HP	130.4
Exh Pres, PSI	10.4
Boost, PSI	16.7
Vol Eff, %	155.7
Actual CFM	159
Fuel Flow, lb/hr	55.38
Nitrous, lb/hr	.00
Ntrs Fuel, lb/hr	.00
BMEP, PSI	293.50
A/F Mxtr Qty, %	100.0
BSFC, lb/HP-hr	4.25
Thermal Eff, %	33.20

Figure A74 Centrifugal Supercharger using Full Compressor Map

Centrifugal Supercharger Specs for: VORTECH--S

Centrifugal Supercharger Specs

Island CFM	650
Island Pressure Ratio	1.55
Island Efficiency, %	73
Island RPM	33000
Internal Gear Ratio	3.45
Belt Ratio	3
Maximum Flow, CFM	1625

Centrifugal Supercharger Specs, cont

Mech Friction	Typical Friction
Max Safe Impeller RPM	55000

General Supercharger Specs

Throttle Location	Blow Through
Max Boost Limit, PSI	100
Number of S/Cs	1 Single S/C
Intercooler Eff, %	0% No Intercooler
Intercooler CFM Rating	100000

Full Compressor Map

Use Compressor Map: Yes

File: @C:\VB98\projects6\EAAPROX\CENTMAP\

Help
Speed up gear ratio within blower, for example most Paxtons use 4.4, some Vortech's use 3.45. p 56

Comments
Single Vortech Centrifugal S/C V2-S trim with no intercooler and 1.75 belt ratio. Change intercooler and belt ratio specs to match your application.

Buttons: OK, Help, Retrieve from Library, Save to Library, Print

Click here to choose to use a full map.

Click here to bring up screen shown below

Click here to show the RPM Graph.

S/C Map [Vortech V5 F trim.CMC]

Pressure Ratio Range (rows): Highest Pressure Ratio 2.6, Pres. Ratio Step Size .2, Preview: 1.00, 1.20, 1.40, ... 2.60

CFM Flow Range (columns): Highest CFM 1000, CFM Step Size 200, Preview: 200, 400, 600, ... 1000

Surge CFM 250

Buttons: Update Graph, Show RPM, Print Table

Pres Ratio	200	400	600	800	1000
1.00 RPM	5000	5000	5000	5000	5000
1.00 Eff%	10	20	20	10	10
1.20 RPM	26000	31000	39500	50000	80000
1.20 Eff%	70	60	38	28	10
1.40 RPM	35500	37500	43000	52000	70000
1.40 Eff%	67	75	61	40	30
1.60 RPM	43500	43500	47500	53500	70000
1.60 Eff%	62	75	72	50	35
1.80 RPM	49000	48500	51500	55500	70000
1.80 Eff%	58	73	72	61	42
2.00 RPM	54500	53000	54000	59000	75000
2.00 Eff%	55	68	73	64	50
2.20 RPM	60000	56500	57500	62000	90000
2.20 Eff%	50	65	70	60	50

Graph: Efficiency contours (80, 75, 70, 65, 60, 55, 50, 45 Eff%) vs Pressure Ratio and CFM.

Buttons: OK (keep changes), Cancel Changes, Save As

The Map is very similar to the Turbocharger Map except you also need an RPM to go with each Thermal Efficiency at each Pressure Ratio and CFM flow data point. For example, this point shows the blower is spinning at 49000 RPM and produces 58% efficiency at a Pressure Ratio of 1.80 at a CFM of 200.

Figure A75 Centrifugal Supercharger using Full Compressor Map, RPM Graph

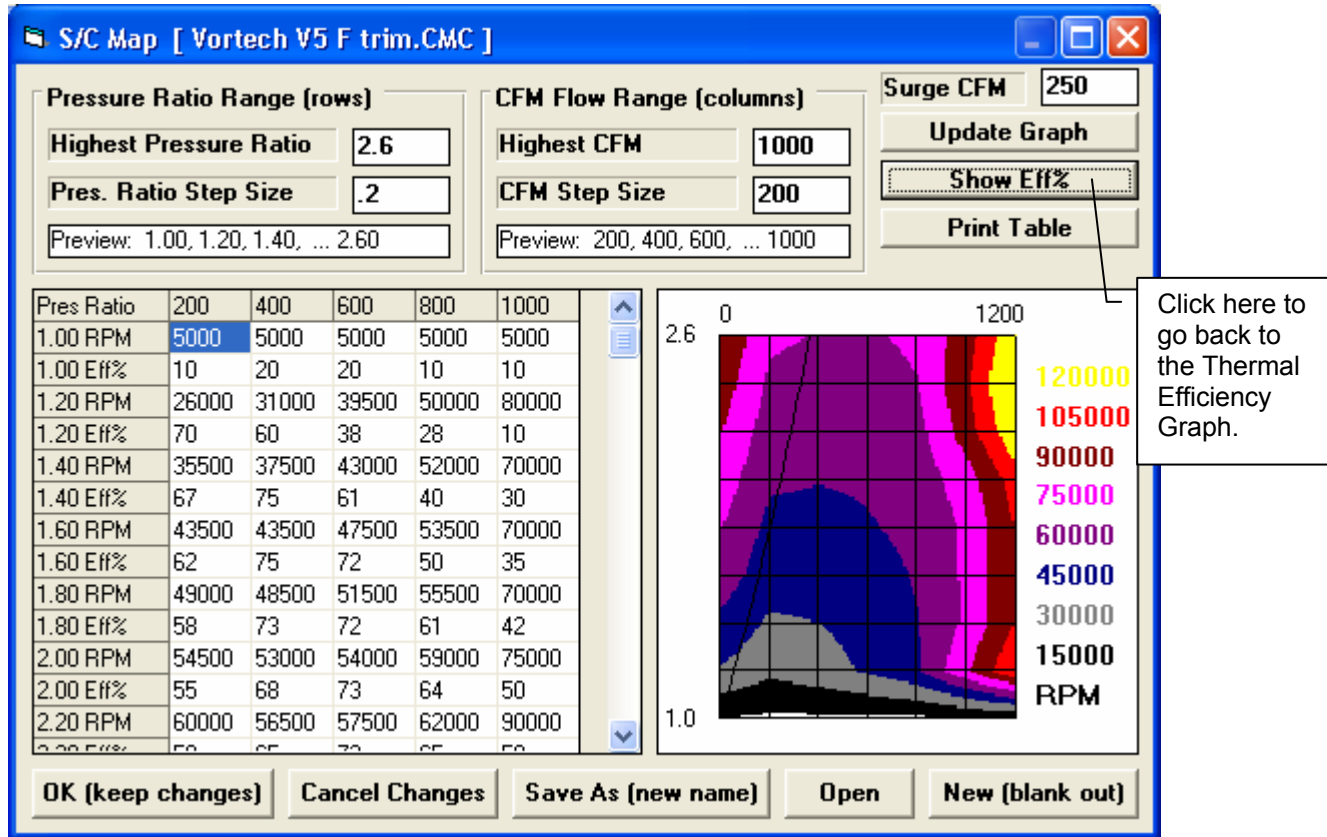

Figure A76 New Supercharger Type, Centrifugal Feeding into a Roots Supercharger

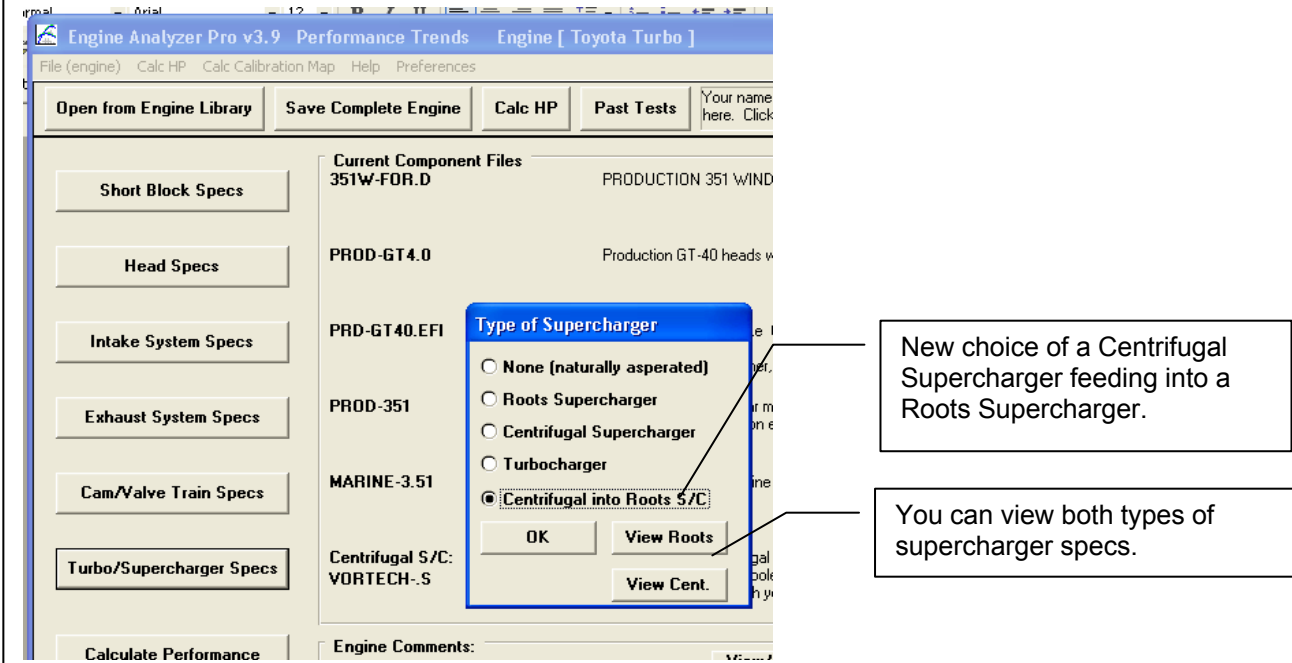
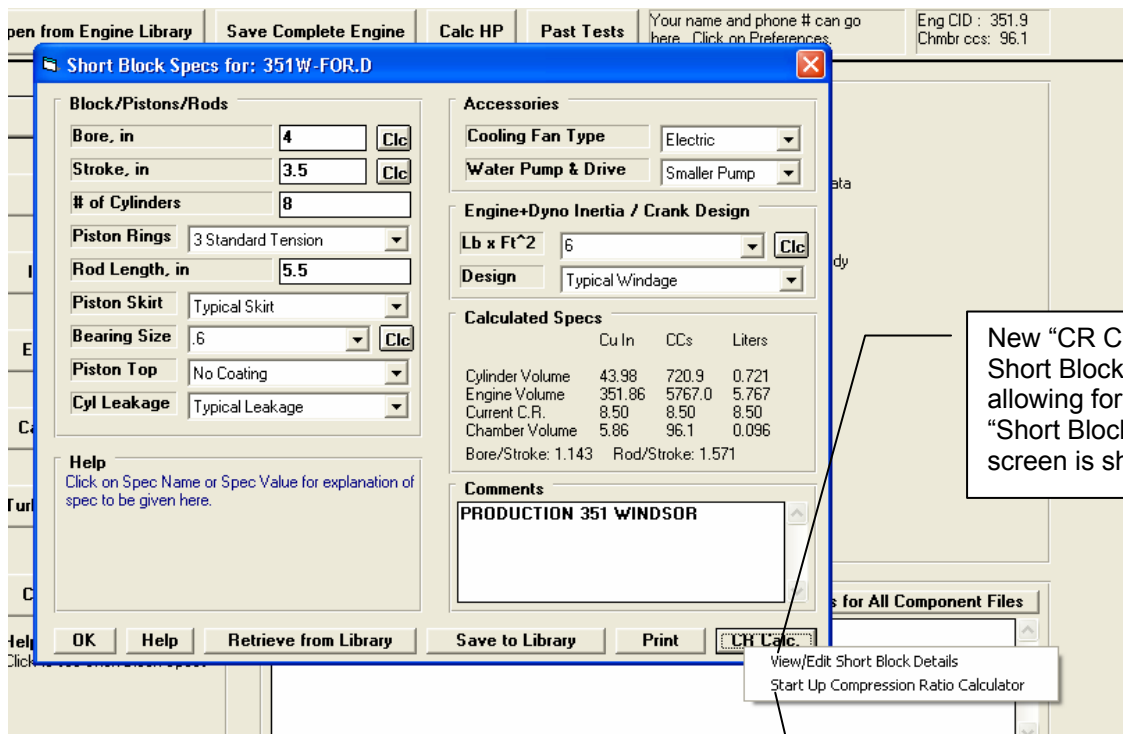

Figure A77 "Talking" to the Compression Ratio Calculator, Short Block Specs



New "CR Calc" button in Short Block Specs, allowing for 2 options. The "Short Block Details" screen is shown below.

View/Edit Short Block Details
Start Up Compression Ratio Calculator

Starting up the Compression Ratio Calculator is shown if Figures A65 and A66

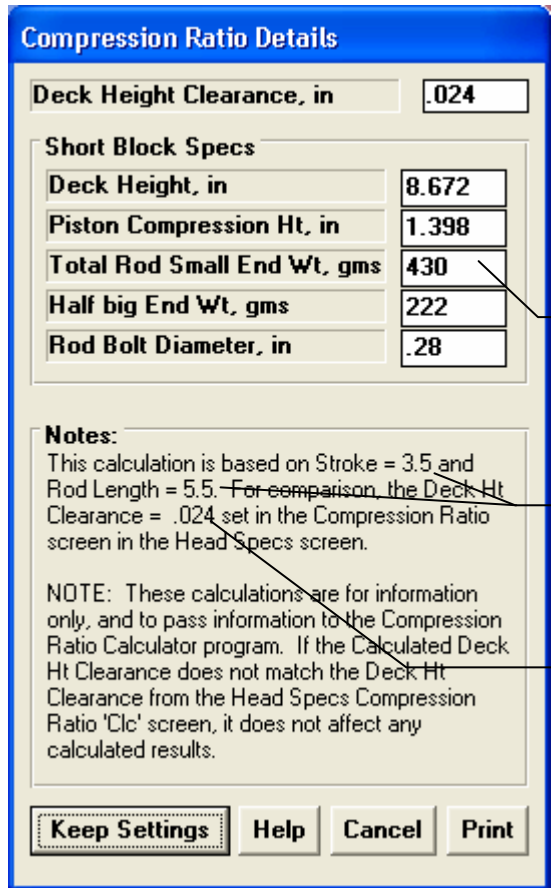

Total Small End Weight includes the piston, wrist pin and keepers, and rings in addition to just the small end of the rod. This is used in the Compression Ratio Calculator to estimate loads on the rod bolts at a particular RPM.

Current Stroke and Rod Length used for the Deck Height Clearance calculation.

Current Deck Height Clearance which has been set in the Compression Ratio utility menu in the Heads Specs screen. See Figure A64. Ideally you will adjust specs either on this screen or the Compression Ratio utility screen to get these to match each other.

Figure A78 "Talking" to the Compression Ratio Calculator, Cylinder Head Specs

Two options from the Cylinder Head Specs screen. The top option shows the same Compression Ratio utility screen in the standard Engine Analyzer Pro. However, in the Enterprise Edition, now these inputs are saved when you leave this screen so they can be transferred to the Compression Ratio Calculator program.

Click here to start up the Compression Ratio Calculator program shown below.

Compression Ratio utility screen in Engine Analyzer Pro (standard version and Enterprise Edition).

If you own the Compression Ratio Calculator program (basic, Plus or Pro versions) and it is installed in the default location, it will start automatically. A note is given here to explain your options.

Figure A79 Actual Compression Ratio Calculator Program Called from Engine Analyzer Pro Enterprise Edition

Compression Ratio PRO - Perf. Trends [ELBData.PTI]
File Options Comments Boring/Stroking Help Reg To: Kevin Ger

Base Engine Inputs

Bore, in	4	Clc
Stroke, in	3.5	Clc
# of Cylinders	8	
Rod Length, in	5.5	Clc
Int Valve Closing, deg		Clc
Deck Height, in	8.672	Clc

Chamber/Piston Inputs

Chamber CCs in Head	46	Clc
Piston Design	Dish Top	
Piston Dish, ccs	5	Clc
Gasket Thickness, in	.032	Clc
Gasket Bore Dia, in	4.022	Clc
Deck Ht Clearance, in	.024	Clc
Piston Ring Depth, in	.26	
Piston Top O.D., in	3.95	
Compression Ht, in	1.398	Clc

Plus Features

Barometric Pres. "Hg	29.6	
Cyl Leakage	Typical (production)	
Turbo or Supercharged	No	
Boost, psi		

Calculated Results

Cylinder Size	Cu. In.	CCs	Liters
Engine Size	43.98	720.9	0.721
Chamber Size	351.86	5767.	5.767
Compression Ratio	3.9	63.9	0.064
Eff. Comp. Ratio	12.27		
Dyn. Comp. Ratio	12.27		
Cranking Pres. PSI	na		
Bore/Stroke Ratio	na		
Rod/Stroke Ratio	1.143		
Quench	1.571		
	.056		

Volume Contributions

	Cu. In.	CCs	% of Total
Head Chamber	2.807	46.	71.9
Gasket	0.407	6.66	10.4
Deck	0.302	4.94	7.7
Piston Dish	0.305	5.	7.8
Piston O.D.	0.081	1.33	2.1

Help
The amount of volume in the cylinder head's combustion chamber, measured in cubic centimeters.

Adjust Specs to get a Desired Comp. Ratio

Max Engine RPM 6000
Total Small End Wt. gms 430 Clc
Half Big End Wt. gms 222 Clc
3500 ft/min 4602 Gs 3068 lbs bolt load

Deck Height Clearance Adjusted
Deck Height Clearance will be adjusted to be consistent with the current Stroke, Rod Length, Deck Height and Compression Ht.
If this is not what you want to have done, click on one of the Calc buttons by the spec you want adjusted to fit the other specs (after you click on OK on this message).
(This notice given only once for each program startup.)
OK

Keep Your Changes?
This file and all current settings will now be loaded back to the 'Engine Log Book'. Is this what you want to do?
Click on 'Cancel' to stop shutting down this Compression Ratio Calculator program.
Click on 'No' to return to the Engine Log Book program but abandon any changes you've made in this program.
Yes No Cancel

Diagram: A technical drawing of a piston and cylinder head assembly, showing the combustion chamber and various components like the gasket, deck, and piston dish.

Callout 1: You will see most all your numbers from the Engine Analyzer Pro transferred over to the Compression Ratio Calculator. Now you can do any other detailed calculations as shown here.

Callout 2: If things do not "add up" as far as deck height stackup, a message is given as shown here and Deck Height Clearance is adjusted to make it "add up". NOTE: The Engine Analyzer Pro does not force these numbers to "add up" as most do not affect engine performance.

Callout 3: When leaving the Compression Ratio Calculator, you are given these 3 options.

Callout 4: If you choose Yes, you will see the numbers from the Compression Ratio Calculator transferred back to the EA Pro.

Figure A80 Some of the Advanced Features in the Actual Compression Ratio Calculator

These 2 screens (and several others for calculating volumes from geometry) are only available in Pro version of Compression Ratio Calculator.

Calc Piston Dish, ccs

Calc Piston Dish, ccs: 18.2

Drawing not to exact scale

Piston Dish Geometry

Shape: Straight Tapered (conical)

Flat edge around piston top: Yes

Flat Edge Width, mm: 8

Taper Angle, deg: 22.5

Depth, mm: 4

Help: These calculations are based on current Piston Top O.D. of 101.5.

Use Calc Value | Help | Cancel | Print

Intal Valve Relief Volume

Net (correct) Volume: 6.12

Overlap Volume: .10

Volume (design min. Ovlp Vol): 6.22

Valve Relief Info

Valve Relief Type: 4 Matching Reliefs

Valve Angle, Deg: 12

Relief Diameter, mm: 48

Depth Into Piston, mm: 4.5

Valve Separation, mm: 40

Offset from Pin Centerline: 8

Notes: These calculations are based on current Piston Top O.D. of 4.

Use Calc Value | Help | Cancel | Print

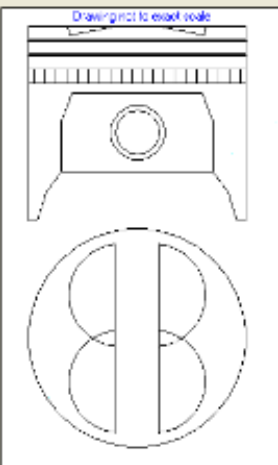

Calc Deck Ht Clearance

Calc Deck Ht Clearance: .000

ADD for Desired Clearance: .000

Adjust Deck Ht for Desired Clearance

Adjust Comp. Ht for Desired Clearance

Engine Data

Deck Height, in: 9.238

Piston Compression Ht, in: 1.33

Rod Length, in: 6.098

Desired Deck Clearance, in: 0

Notes:

- This calculation is based on the current Stroke = 3.62. If this is incorrect, change this spec before using this menu.
- Enter a negative (-) Desired Deck Clearance if you want the piston to go above the deck at TDC.
- Click on one of the 'Adjust' buttons at the top to produce your 'Desired Deck Height Clearance'.

Use Calc Value | Help | Cancel | Print

Calc Dome CCs

Calc Dome CCs: 27.2

Checking Data

Piston Bore, in: 3.9

Piston Depth in Bore, in: .2

Plate Design: 'Smokey' Cavity Plate

Volume of Plate, CCs: 100

CCs of Fluid, CCs: 112

Notes:

This calculation menu uses results from Ccing the top of a piston in the bore. The piston is placed down the bore a measured depth. If the piston is at TDC, this would be the Deck Height Clearance. The edge of the piston is sealed with grease. A flat plate, or plate with a circular 'cavity' of known volume (sometimes credited to 'Smokey' Yunik) is bolted to the bore. Liquid is added to fill the space above the piston and the cavity in the plate (if any).

Use Calc Value | Help | Cancel | Print

Automatically adjusting specs to find a desired Compression Ratio.

Adjust Specs to get a Desired Comp. Ratio

- By Adjusting Chamber CCs
- By Adjusting Gasket Thickness
- By Adjusting Piston Top
- By Adjusting Deck Ht Clearance

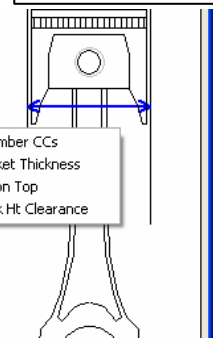

Piston Design: Flat Top w Valve Relief

Head Chamber: 4.118 67.5 87.8

Valve Reliefs, ccs: 0.503 9.24 10.7

Gasket Thickness, in: .04

Gasket Bore Dia, in: 4

Deck Ht Clearance, in: 0

Piston Ring Depth, in: .22

Piston Top O.D., in: 3.85

Compression Ht, in: 1.33

Plus Features

Barometric Pres, "Hg: 29.92

Cyl Leakage: Typical (production)

Turbo or Supercharged: Yes

Max Engine RPM: 6000

Total Small End Wt, gms: 450

Half Big End Wt, gms: 250

Pick a FelPro Head Gasket

OK (use this gasket) | Cancel | www source

- 1024 Ford L6 4.180 .039 8.9
- 1025 Chevrolet L6 4.166 .041 9.1
- 1026 Buick V6 4.090 .039 8.5
- 1027 Chevrolet V8 Big Block 4.370 .039 9.7
- 1028 Ford V8 Big Block 4.670 .041 11.4
- 1029 Chevrolet V6 3.620 .039 6.7
- 1031 L Ford V8 Small Block 4.150 .041 9.4
- 1031 R Ford V8 Small Block 4.150 .041 9.4

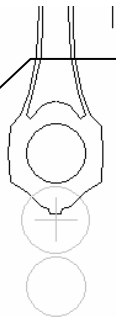

Picking gasket specs from pre-loaded list of gaskets.

Figure A81 Calculating a Part Throttle "Calibration" Map

Click here at top of main screen for these options.

Calibration Map

Calibration Map
 MAP Steps, psi: 2 psi
 Highest Map, psi: Full Power, WOT
 Lowest Map, psi: 4

Keep Specs Help Cancel Print

Here's the Map Details, which is basically the starting and ending MAP (manifold absolute pressure) points and increments. The RPMs which are run are set the same as for WOT (wide open throttle) performance, in the Calculate Performance screen.

Click on ASCII File to produce the 2 types of files shown in Figure A68. You will be asked for a file name and folder for storing the files. Then the program will write 2 files, a ".csv" or comma separated variable file which imports to Excel, or a ".txt" file which is tab delimited and reads better in Microsoft Word.

Here's the MAP for each section of results. The first section was a WOT, so map changes as manifold vacuum changes.

Engine RPM	1000	1500	2000	2500	3000	3500	4000	4500	5000	5500
Brk Tq, ft-lbs	284.21	308.29	321.89	332.44	352.29	358.92	341.86	304.79	257.02	210.09
Brake HP	54.11	88.05	122.58	158.24	201.23	239.19	260.37	261.15	244.69	220.01
MAP, psi	14.5	14.5	14.5	14.5	14.4	14.4	14.3	14.3	14.3	14.3
Vol Eff, %	72.8	75.3	78.6	82.3	88.5	92.3	90.9	85.7	76.5	73.7
BSFC, lb/HP-hr	.479	.456	.456	.462	.469	.480	.496	.525	.556	.655
Injctr Dty Cyc, %	17.036	26.412	36.764	48.139	62.146	75.586	85.040	90.238	89.456	94.825
Inj Plse Wdth, ms	20.443	21.129	22.058	23.107	24.859	25.915	25.512	24.063	21.469	20.689
A/F Mxtr Qlty, %	93.9	100.0	100.0	100.0	100.0	100.0	100.0	100.0	100.0	100.0
Knock Index	2.6	2.3	2.2	1.9	1.9	1.8	1.6	1.3	1.0	.8
Spark Advnc, deg	20.2	22.5	24.1	25.4	26.3	27.2	28.5	29.9	31.9	33.5
Fuel Flow, lb/hr	25.89	40.15	55.88	73.17	94.46	114.89	129.26	137.16	135.97	144.13
Brk Tq, ft-lbs	268.57	292.71	306.29	317.75	337.49	345.95	330.63	296.36	248.51	203.65
Brake HP	51.14	83.60	116.64	151.25	192.78	230.54	251.81	253.93	236.58	213.27
MAP, psi	14.0	14.0	14.0	14.0	14.0	14.0	14.0	14.0	14.0	14.0
Vol Eff, %	69.7	72.1	75.5	79.3	85.6	89.6	88.5	83.7	74.7	72.1
BSFC, lb/HP-hr	.484	.460	.460	.466	.474	.484	.500	.527	.562	.661
Injctr Dty Cyc, %	16.296	25.318	35.322	46.366	60.087	73.409	82.856	88.069	87.408	92.781
Inj Plse Wdth, ms	19.555	20.254	21.193	22.255	24.035	25.169	24.857	23.485	20.978	20.243
A/F Mxtr Qlty, %	93.9	100.0	100.0	100.0	100.0	100.0	100.0	100.0	100.0	100.0
Knock Index	2.4	2.2	2.1	1.9	1.8	1.7	1.5	1.3	1.0	.8
Spark Advnc, deg	20.4	22.8	24.4	25.7	26.5	27.4	28.6	30.0	32.2	33.7
Fuel Flow, lb/hr	24.77	38.48	53.69	70.48	91.33	111.58	125.94	133.87	132.86	141.03
Brk Tq, ft-lbs	211.98	232.04	243.80	254.20	271.16	277.60	263.61	233.25	191.09	152.92
Brake HP	40.36	66.27	92.84	121.00	154.89	185.00	200.77	199.86	181.92	160.14
MAP, psi	12.0	12.0	12.0	12.0	12.0	12.0	12.0	12.0	12.0	12.0
Vol Eff, %	58.1	60.2	63.2	66.5	72.0	75.4	74.2	69.8	62.1	59.8
BSFC, lb/HP-hr	.512	.485	.484	.489	.496	.507	.525	.559	.607	.731
Injctr Dty Cyc, %	13.591	21.144	29.588	38.902	50.529	61.708	69.405	73.518	72.659	76.961

Figure A82 Part Throttle "Calibration" Map Written to ASCII Files (see Fig A81)

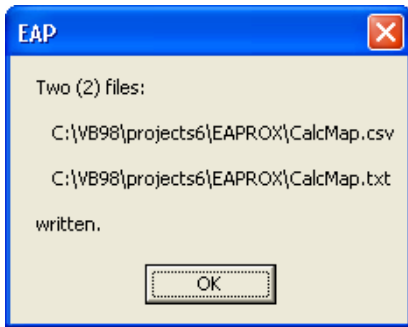

Notepad displaying the .txt format file.

CalcMap.txt - Notepad

Engine RPM	1000	1500	2000	2500	3000	3500	4000	4500	5000	5500
Brk Tq; ft-lbs	284	308	322	332	352	359	342	305	257	210
Brake HP	54.1	88.1	122.6	158.2	201.2	239.2	260.4	261.1	244.7	220.0
MAP; psi	14.5	14.5	14.5	14.5	14.4	14.4	14.3	14.3	14.3	14.3
Vol Eff; %	72.8	75.3	78.6	82.3	88.5	92.3	90.9	85.7	76.5	73.7
BSFC; lb/HP-hr	.479	.456	.456	.462	.469	.480	.496	.525	.556	.655
Injctr Dty Cyc; %	17.036	26.412	36.764	48.139	62.146	75.586	85.040	90.238	89.456	94.825
Inj Plse Wdth; ms	20.443	21.129	22.058	23.107	24.859	25.915	25.512	24.063	21.469	20.689
A/F Mxtr Qlty; %	93.9	100.0	100.0	100.0	100.0	100.0	100.0	100.0	100.0	100.0
Knock Index	2.6	2.3	2.2	1.9	1.9	1.8	1.6	1.3	1.0	.8
Spark Advnc; deg	20.2	22.5	24.1	25.4	26.3	27.2	28.5	29.9	31.9	33.5
Fuel Flow; lb/hr	25.89	40.15	55.88	73.17	94.46	114.89	129.26	137.16	135.97	144.13
Brk Tq; ft-lbs	269	293	306	318	337	346	331	296	249	204
Brake HP	51.1	83.6	116.6	151.3	192.8	230.5	251.8	253.9	236.6	213.3
MAP; psi	14.0	14.0	14.0	14.0	14.0	14.0	14.0	14.0	14.0	14.0
Vol Eff; %	69.7	72.1	75.5	79.3	85.6	89.6	88.5	83.7	74.7	72.1
BSFC; lb/HP-hr	.484	.460	.460	.466	.474	.484	.500	.527	.562	.661
Injctr Dty Cyc; %	16.296	25.318	35.322	46.366	60.087	73.409	82.856	88.069	87.408	92.781
Inj Plse Wdth; ms	19.555	20.254	21.193	22.255	24.035	25.169	24.857	23.485	20.978	20.243
A/F Mxtr Qlty; %	93.9	100.0	100.0	100.0	100.0	100.0	100.0	100.0	100.0	100.0

CalcMap.csv - Microsoft Excel

Engine RPM	1000	1500	2000	2500	3000	3500	4000	4500	5000	5500
Brk Tq; ft-lbs	284.21	308.29	321.89	332.44	352.29	358.92	341.86	304.79	257.02	210.09
Brake HP	54.11	88.05	122.58	158.24	201.23	239.19	260.37	261.15	244.69	220.01
MAP; psi	14.5	14.5	14.5	14.5	14.4	14.4	14.3	14.3	14.3	14.3
Vol Eff; %	72.8	75.3	78.6	82.3	88.5	92.3	90.9	85.7	76.5	73.7
BSFC; lb/HP-hr	0.479	0.456	0.456	0.462	0.469	0.480	0.496	0.525	0.556	0.655
Injctr Dty Cyc; %	17.036	26.412	36.764	48.139	62.146	75.586	85.04	90.238	89.456	94.825
Inj Plse Wdth; ms	20.443	21.129	22.058	23.107	24.859	25.915	25.512	24.063	21.469	20.689
A/F Mxtr Qlty; %	93.9	100	100	100	100	100	100	100	100	100
Knock Index	2.6	2.3	2.2	1.9	1.9	1.8	1.6	1.3	1	0.8
Spark Advnc; deg	20.2	22.5	24.1	25.4	26.3	27.2	28.5	29.9	31.9	33.5
Fuel Flow; lb/hr	25.89	40.15	55.88	73.17	94.46	114.89	129.26	137.16	135.97	144.13
Brk Tq; ft-lbs	268.57	292.71	306.29	317.75	337.49	345.95	330.63	296.36	248.51	203.65
Brake HP	51.14	83.6	116.64	151.25	192.78	230.54	251.81	253.93	236.58	213.27
MAP; psi	14	14	14	14	14	14	14	14	14	14
Vol Eff; %	69.7	72.1	75.5	79.3	85.6	89.6	88.5	83.7	74.7	72.1
BSFC; lb/HP-hr	0.484	0.46	0.46	0.466	0.474	0.484	0.5	0.527	0.562	0.661
Injctr Dty Cyc; %	16.296	25.318	35.322	46.366	60.087	73.409	82.856	88.069	87.408	92.781
Inj Plse Wdth; ms	19.555	20.254	21.193	22.255	24.035	25.169	24.857	23.485	20.978	20.243

Microsoft™ Excel displaying the .csv format file.

Figure A83 Language Translation and Other Preferences

New tab of Enterprise Edition Preferences

Choose amount you want these "stiffnesses" to be increased beyond the program's default assumptions. Typically increasing the stiffness improves valve train dynamics.

You can choose a different language here. See below.

Changing the Valve Toss Threshold will change the point at which you see warnings about Valve Toss in the output as shown here.

Engine RPM	5000	6000	7000	8000	
Coolant HP	121.00	120.00	55.30	5.52	
Blow By, CFM	4.9	4.3	3.0	1.7	
In Tun Pres, PSI	6.9	4.9	.7	-1.0	
Avg In Vel, ft/sec	292	351	409	468	
Avg Ex Vel, ft/sec	358	430	502	573	
Mach #	.655	.667	.702	.798	.900
Act In FlowArea, %	98.1	115.5	128.0	128.8	128.5
Act Ex FlowArea, %	97.2	101.2	113.8	120.8	121.3
Valve Toss	None	In&Ex	In&Ex	In&Ex	In&Ex
Knock Index	4.6	1.8	.1	.0	.0
Spark Advnc, deg	37.3	38.8	39.5	41.4	44.8
Injctr Dty Cyc, %	91.888	101.293	109.998	100.835	86.156
Inj Plse Wdth, ms	22.053	20.259	18.857	15.125	11.487
Calc Error	0	0	1	0	0

Changing language changes descriptions of inputs, and also brings up Balloon showing description in "Help"

If you change language, not all labels and choices are

Description in Help Frame.

Engine Analyzer Pro v3.9 Tip

Jedes Mal, wenn Sie Hilfe benötigen, an einem Eingang:

- Klicken Sie auf das spec Namen oder
- Klicken Sie auf das Eingabefeld

Und eine kurze Definition wird hier mit einer Seite # im Handbuch für weitere Informationen gegeben.

Don't show this again

Most critical "Tip" messages are also given in the chosen language. As we receive feedback from users, more items in the program will be translated, and the translations are likely to

Figure A84 Compressor Map – Translating from .jpg File

In the Turbo specs screen, set Use Compressor Map to Yes. Then click on the View button

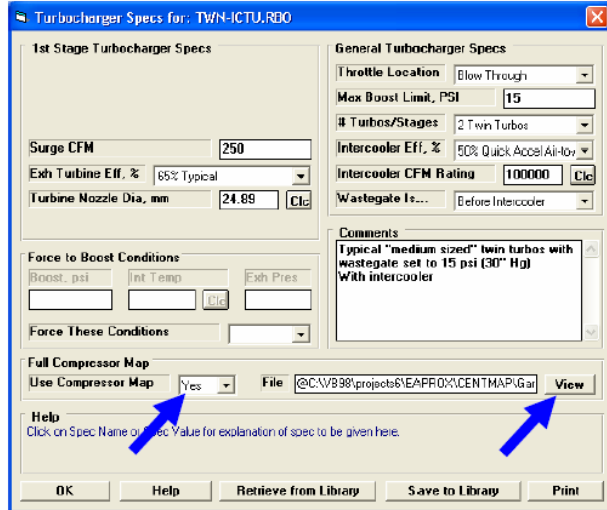

Fill in the Pressure Ratio Ranges and CFM Flow Ranges specs to tell program how many data points you want to enter for your particular map.

Click on Options, then Show Image for Translating for screen on next page.

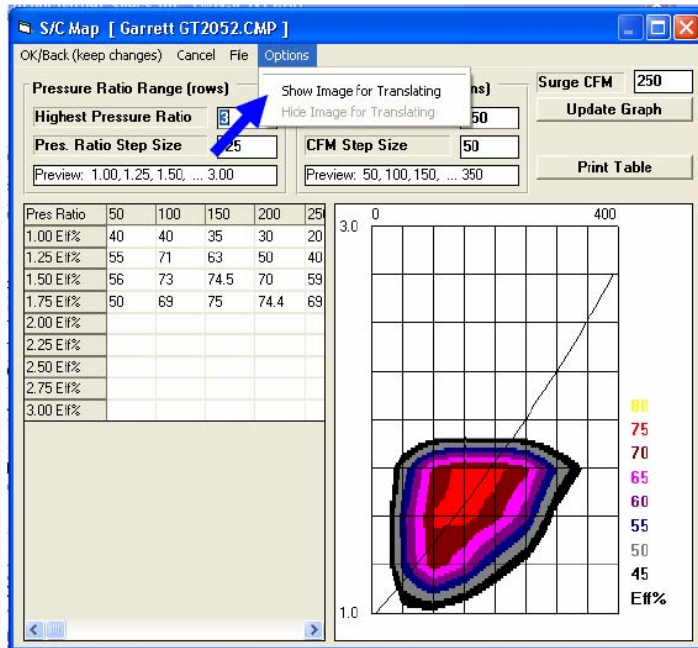
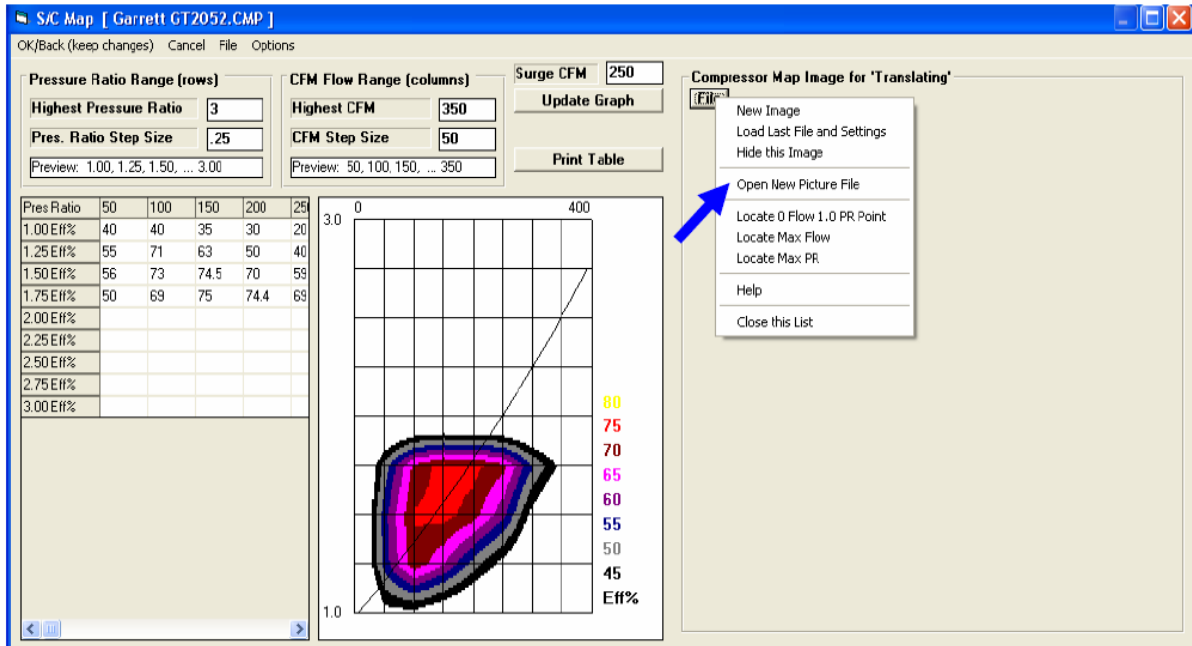

Figure A85 Compressor Map – Translating from .jpg File, cont

A new section of screen opens to the right. Click on the File button for a list of options. Click on the Open New Picture File and browse to a graphic image file of the turbo map you want to Translate to the Engine Analyzer program. These are typically .jpg files which you can get from the internet.



Once the image is loaded, you need to define the max limits of the turbo map image. Click on "Locate 0 Flow and 1.0 PR Point" option and then click on that point in the lower left corner of the map. Lines will be drawn for the lower and left boundaries of the map image.

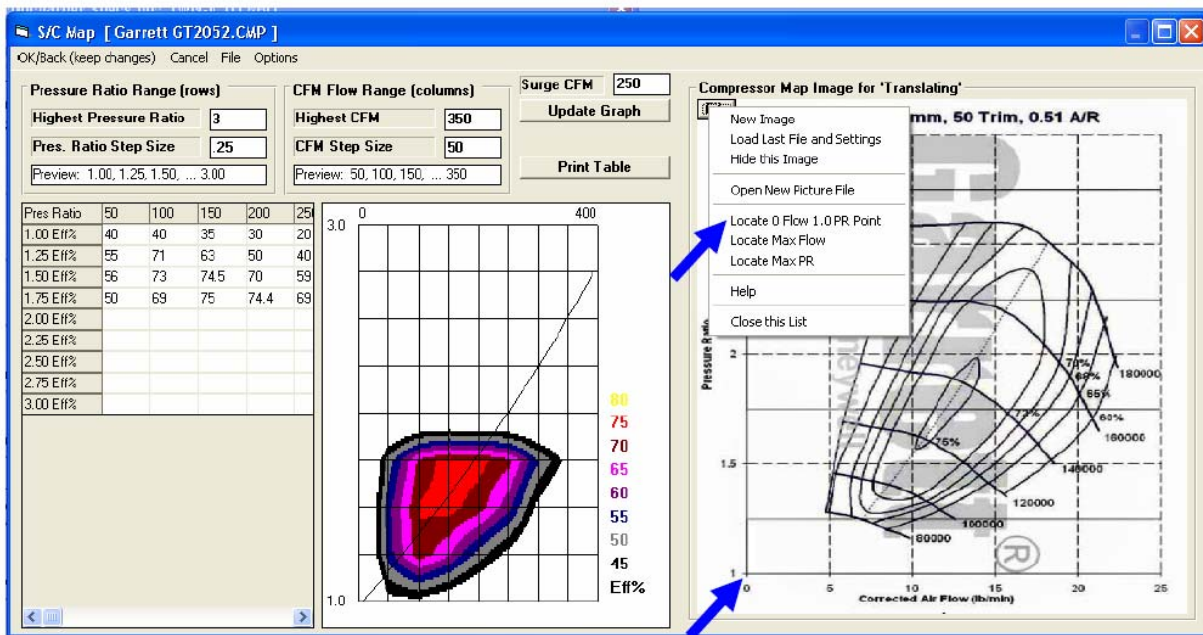
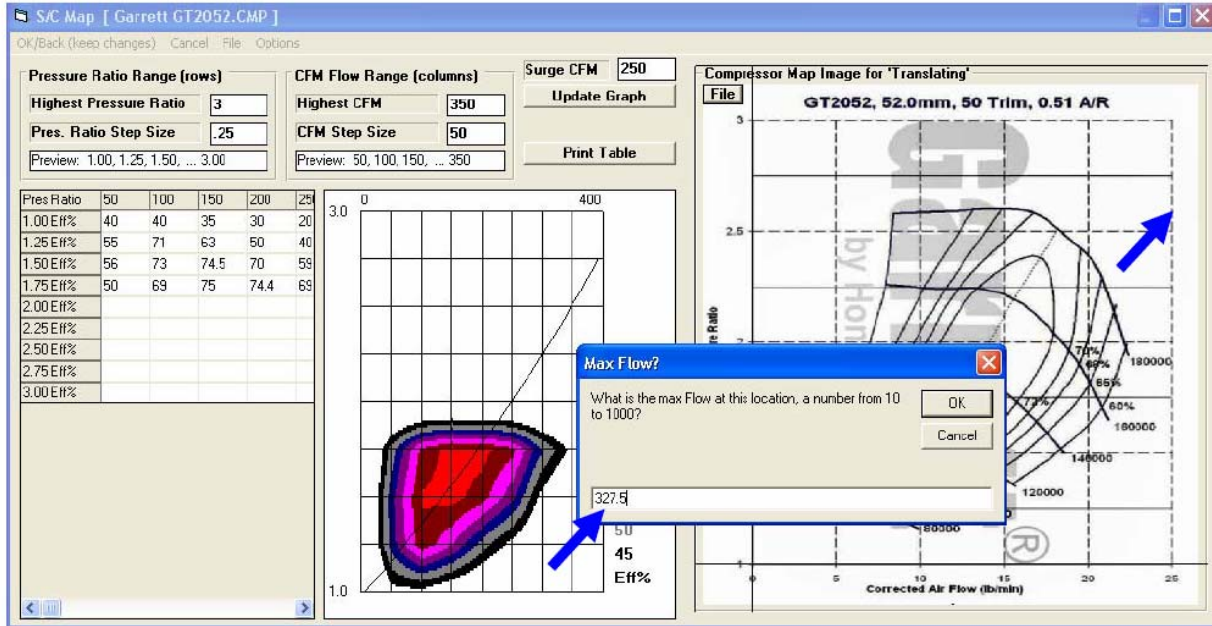

Figure A86 Compressor Map – Translating from .jpg File, cont

After left and bottom limit lines are drawn, click on “Locate Max Flow” option and then click on the right limit of the image. In this case, the right limit of flow is 25 lb/min. Click any place on the vertical 25 lb/min line. The program asks you what is the flow at this line. To convert lb/min to CFM, multiply by 13.1, which is 327.5.



Do the same to identify the Max PR line. Click on the “Locate Max PR” option in the list, then click on the 3 PR line and enter the value of 3. The image below shows the image with boundary lines show on all 4 sides.

Now when you click in the grid to enter an efficiency value, a pink cross hair is drawn on the image so you can precisely read the efficiency value off the image.

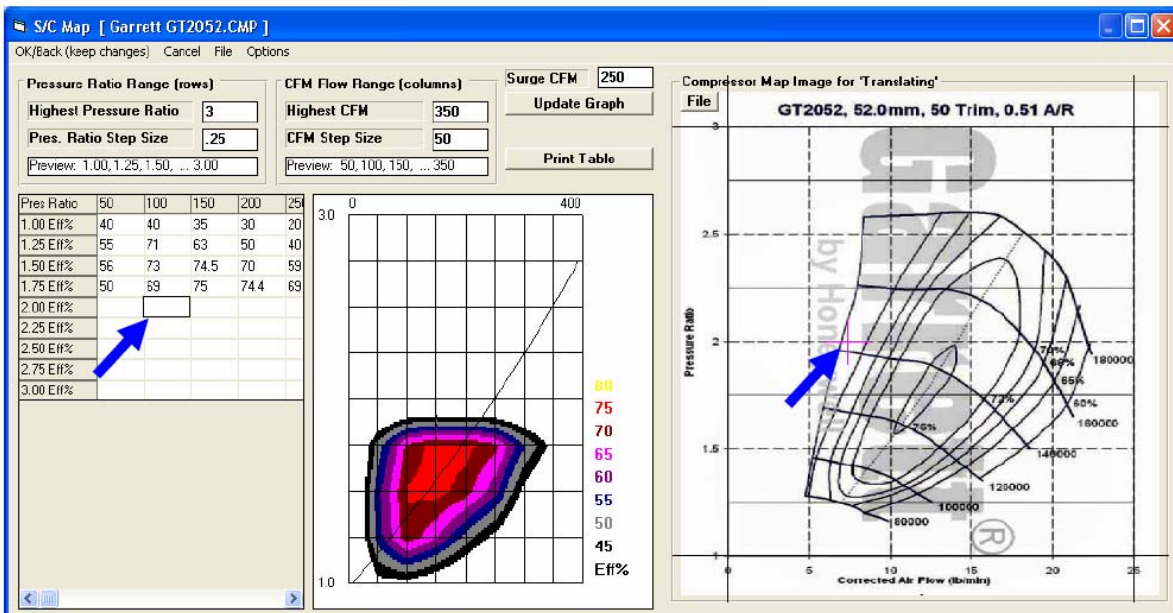

Figure A87 Compressor Map – New Features

The screenshot shows the 'S/C Map [Comp Testing Turbo Small.CMP]' window. The interface includes a menu bar with 'Convert' and 'Options'. A 'Convert' dropdown menu is open, showing options: 'Convert lb/min to CFM' and 'Multiply by a Factor'. The main window has input fields for 'Highest Pressure Ratio' (5.6), 'Pres. Ratio Step Size' (0.2), 'Highest CFM' (2150), and 'CFM Step Size' (145.25). A 'Surge CFM' field is set to 180. There are buttons for 'Update Graph' and 'Print Table'. A data table is displayed on the left, and a compressor map is on the right. A callout box on the right explains that clicking on a point on the map highlights the corresponding cell in the table.

Pres Ratio	872	1017	1162	1307
2.20 Eff%	84	85	80	75
2.40 Eff%	85	90	85	78
2.60 Eff%	85	90	90	84
2.80 Eff%	84	90	90	90
3.00 Eff%	82	90	90	90
3.20 Eff%	80	87	90	90
3.40 Eff%	77	85	90	90
3.60 Eff%	75	81	86	87
3.80 Eff%	73	77	83	85
4.00 Eff%	67	75	78	82
4.20 Eff%	65	73	76	80
4.40 Eff%	63	70	74	78
4.60 Eff%	61	68	72	76
4.80 Eff%	59	66	70	74
5.00 Eff%	57	64	68	72
5.20 Eff%	55	62	66	70
5.40 Eff%	50	57	60	65
5.60 Eff%	45	50	55	60

New "Convert" options to factor the CFM you've entered up or down, or convert from lb/min to CFM

You can click on a point on the map and have the cell containing that data highlighted. This lets you quickly track down points on the map which may have errors.

Figure A88 Valve Spring Harmonics (Dynamics)

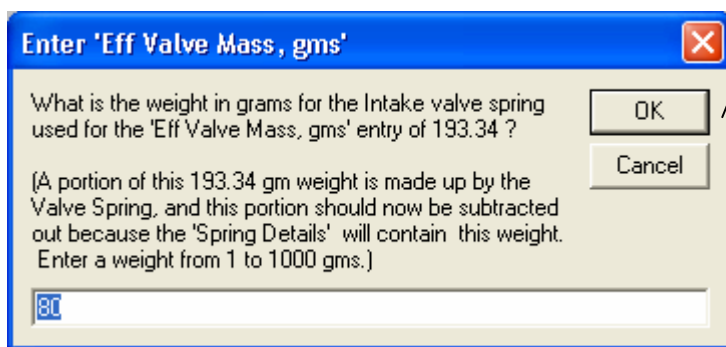
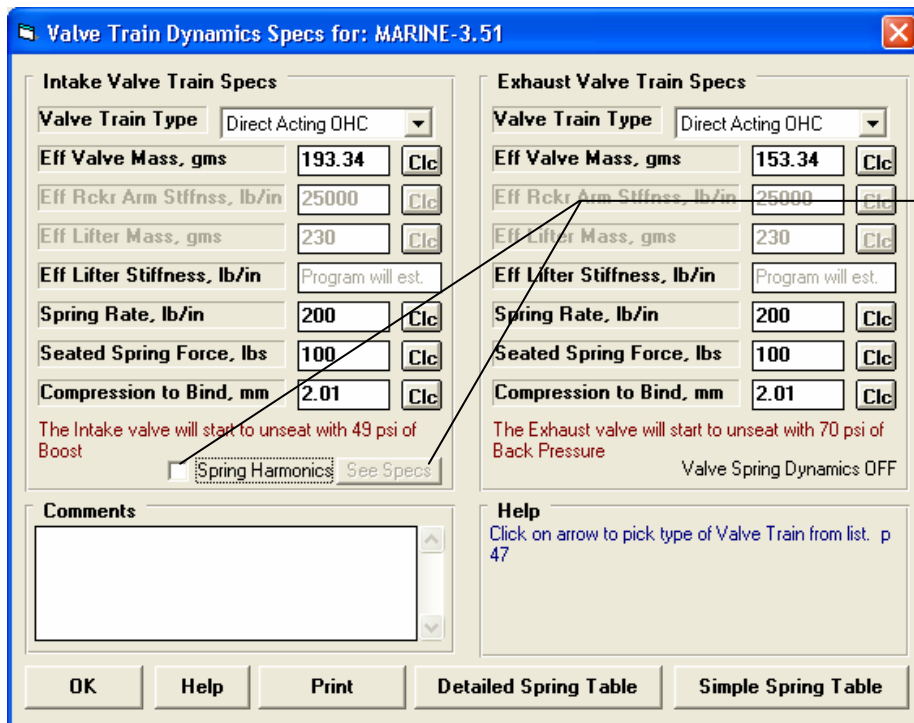
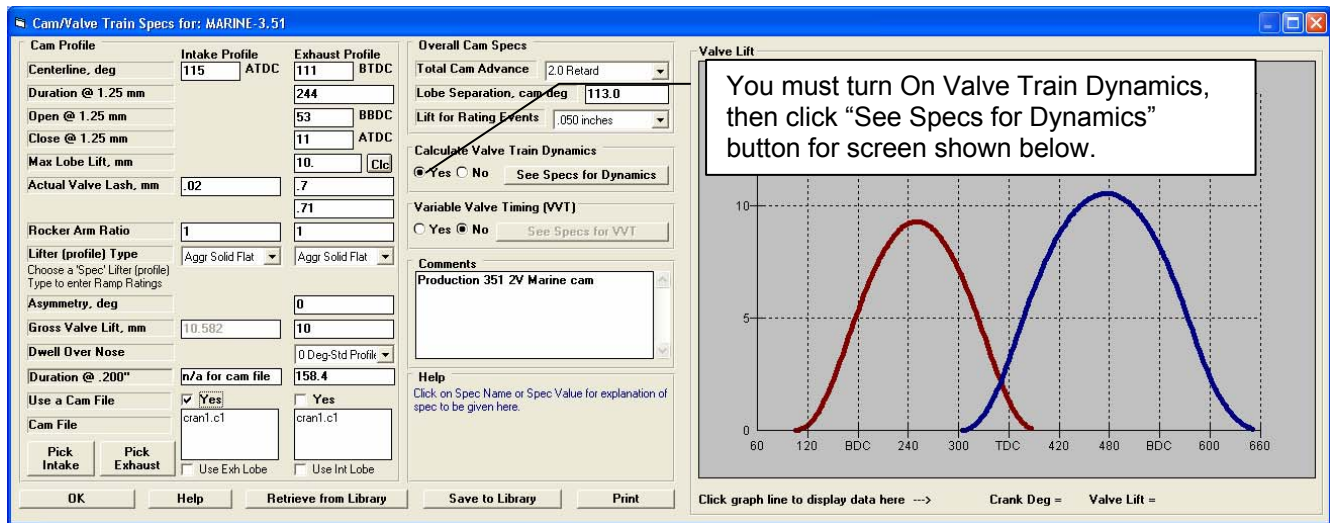

When you first turn On Spring Harmonics, the program reminds you that the "Eff Valve Mass" includes the proper portion of the valve spring mass if you are NOT doing Spring Harmonics. If you ARE doing Spring Harmonics, the "Eff Valve Mass" should be recalculated to NOT include the valve spring mass because the Spring Details tell the program the valve spring mass.

Figure A89 Valve Spring Dynamics, cont

Inputs, help, changing input values are done much the same on all other input screens.

Click on an input name and it's definition is given on "Help" frame at bottom of screen.

Click on choice here to select 1, 2 or 3 springs in the total spring pack.

	Intake			Exhaust		
	1st	2nd	3rd	1st	2nd	3rd
Present	Yes	Yes	Yes	Yes	Yes	Yes
Number of Active Coils	3.25	4.75	6.	3.25	4.75	6.
Wire Diameter, in	.236	.162	.118	.236	.162	.118
Coil Outside Dia, in	1.677	1.21	.875	1.677	1.21	.875
Spring Rate, lb/in	460.1	181.7	107.4	460.1	181.7	107.4
Free Standing Ht, in	2.748	2.755	2.585	2.748	2.755	2.585
Seated Ht, in	2.23	2.230	2.230	2.23	2.230	2.230
Total Spring Rate, lb/in	749.2			749.2		
Calc. Spring Rate, lb/in	460.1	181.7	107.4	460.1	181.7	107.4
Calc. Total Spring Rate, lb/in	749.2			749.2		
Calc. Seated Force, lb	238.3	95.4	38.1	238.3	95.4	38.1
Calc. Total Seated Force, lb	371.9			371.9		
Calc. Spring Wt, gms	103.4	48.0	22.4			
Calc. Total Spring Wt, gms	173.8					
Calc. Coil Clearance, in		.005	.011		.005	.011
Calc. Bind Ht, in	1.239	1.094	.944	1.239	1.094	.944

Click here for the 4 options shown.

Click here to save all inputs shown on this screen.

Click here for more info on inputs and features on this screen.

Click here to save your changes and return to the Valve Train Dynamics screen.

Choose one of the Spring Wiz options to import data from your Spring Wiz program.

- Open Example from Performance Trends
- Open from My Saved Files
- Open Intake Spring(s) from Spring Wiz
- Open Exhaust Spring(s) from Spring Wiz

Figure A90 Valve Spring Dynamics, cont

To show Valve Spring Dynamics, you must first set the graph screen to doing "Cycle" graphs by clicking on the "RPM-cyc" choice here. If this choice is shown as "rpm-CYC", the graph is already doing Cycle graphs.

The "100%" spring position is on the head and does not move. In this graph, it is about 2.25" from the retainer.

Then click 'SINGLE' to bring up the list of graph choices shown here.

Here you can choose which spring to graph (4 is not yet a valid choice).

Check this box to show valve spring animation.

- spring metric coil clash 2:59 pm 7000
- Spring 0%
- Spring 10%
- Spring 20%
- Spring 30%
- Spring 40%
- Spring 50%
- Spring 60%
- Spring 70%
- Spring 80%
- Spring 90%
- Spring 100%

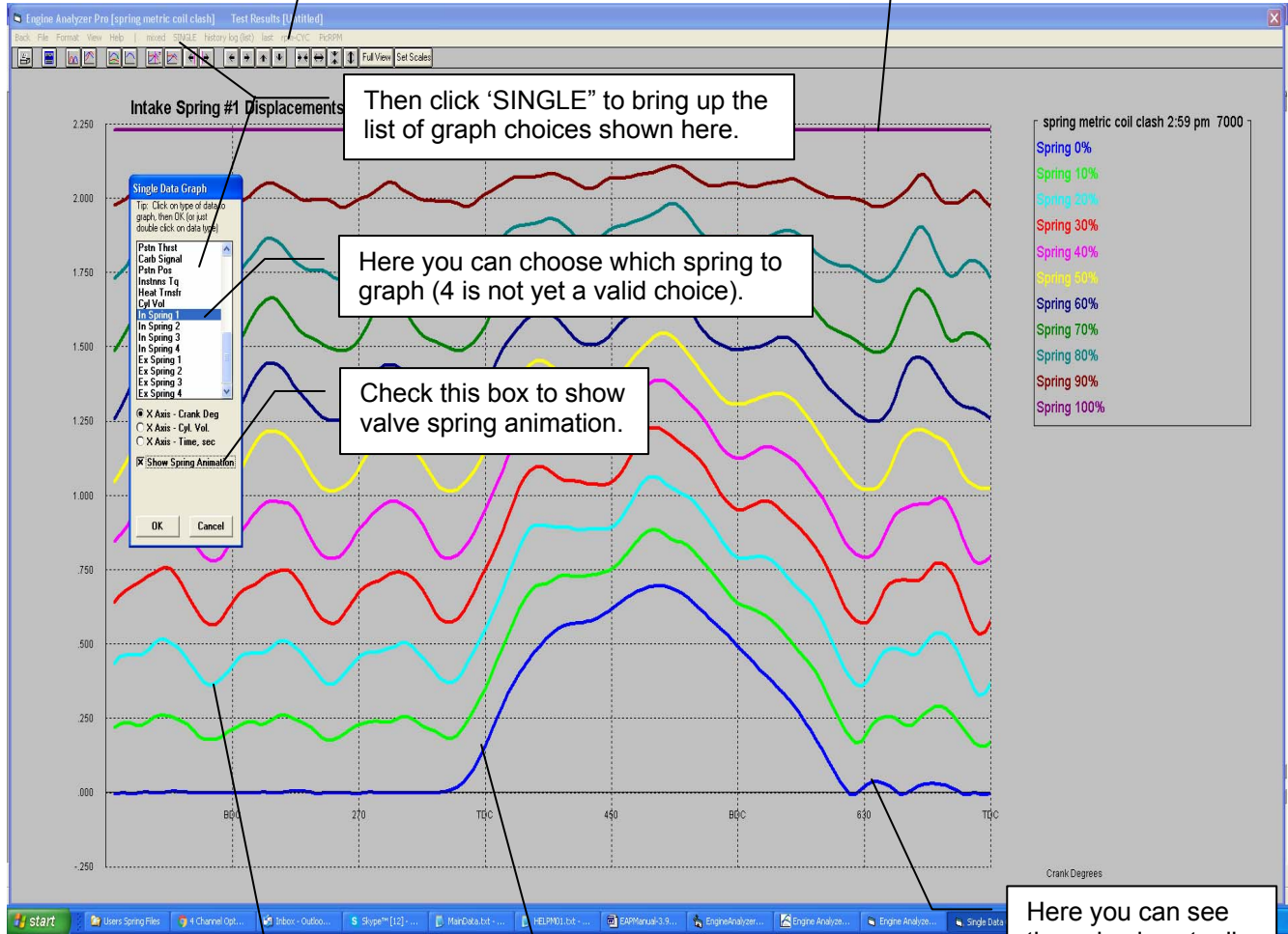

Here you can see the valve is actually bouncing slightly when it reseats.

This is the spot (0 %) on spring which is touching the valve retainer, which is also indicating what the valve itself is doing. The program assumes the retainer and valve follow the same motion.

These lines do not represent individual coils, but portions of the spring coil along its total length. For example, for a spring with 5 coils, this "20%" line would be at a position 1 full coil from the retainer.

Figure A91 Valve Spring Dynamics, cont

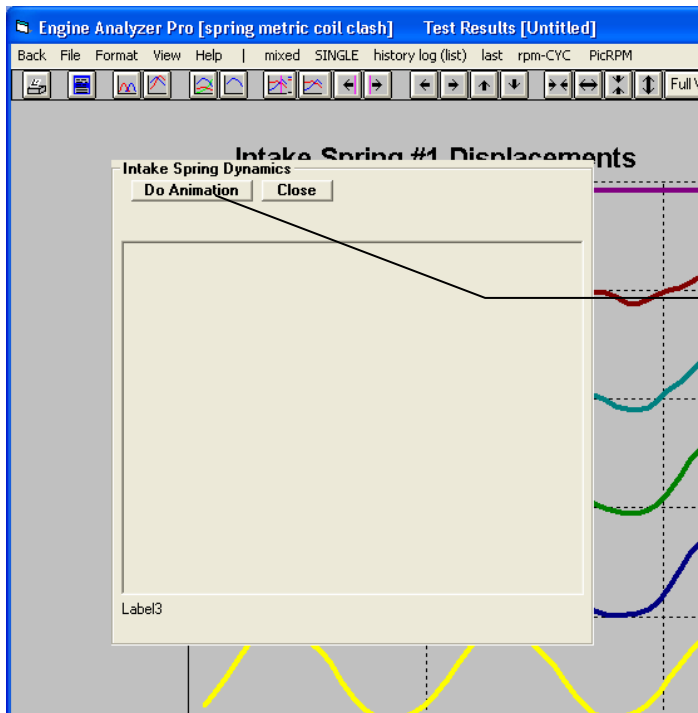

If you have chosen to Do Animation, this "Spring Dynamics" frame will appear on top of the graph. Click the Do Animation button to start animation as shown below.

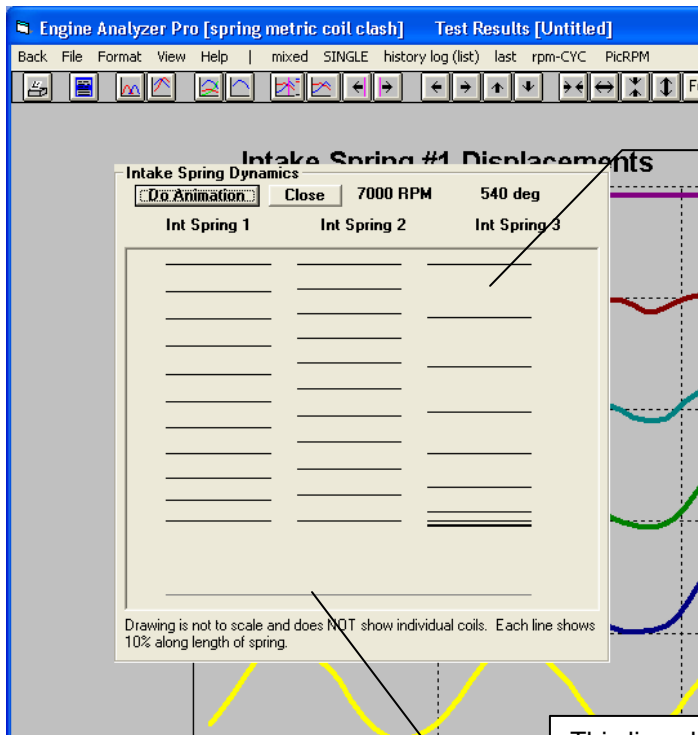

It is difficult to see dynamics in this still picture, but this 3rd spring shows a big separation of the coils here at the position closest to the head.

It also shows the coils likely touching here at the position closest to the retainer, at the bottom of this animation screen.

The #1 and #2 spring are maintaining the coils spacing relatively well, showing spring "surge" is unlikely in those springs.

This line shows valve seat position. When lowest spring line is on this line, the valve is seated. Shown here, the valve (and the coil on the retainer) are lifted off the seat.

Figure A92 Valve Spring Dynamics, cont

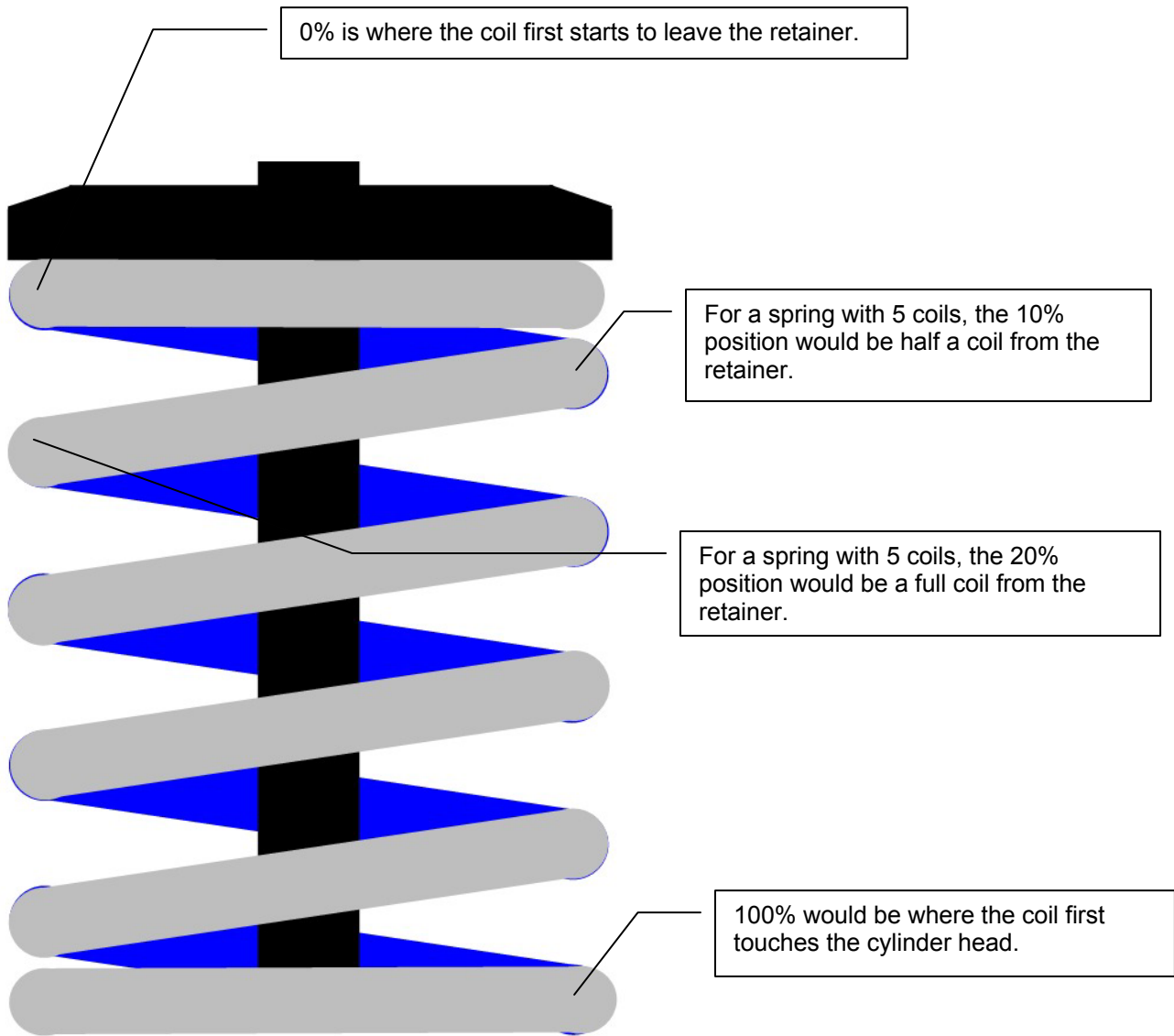
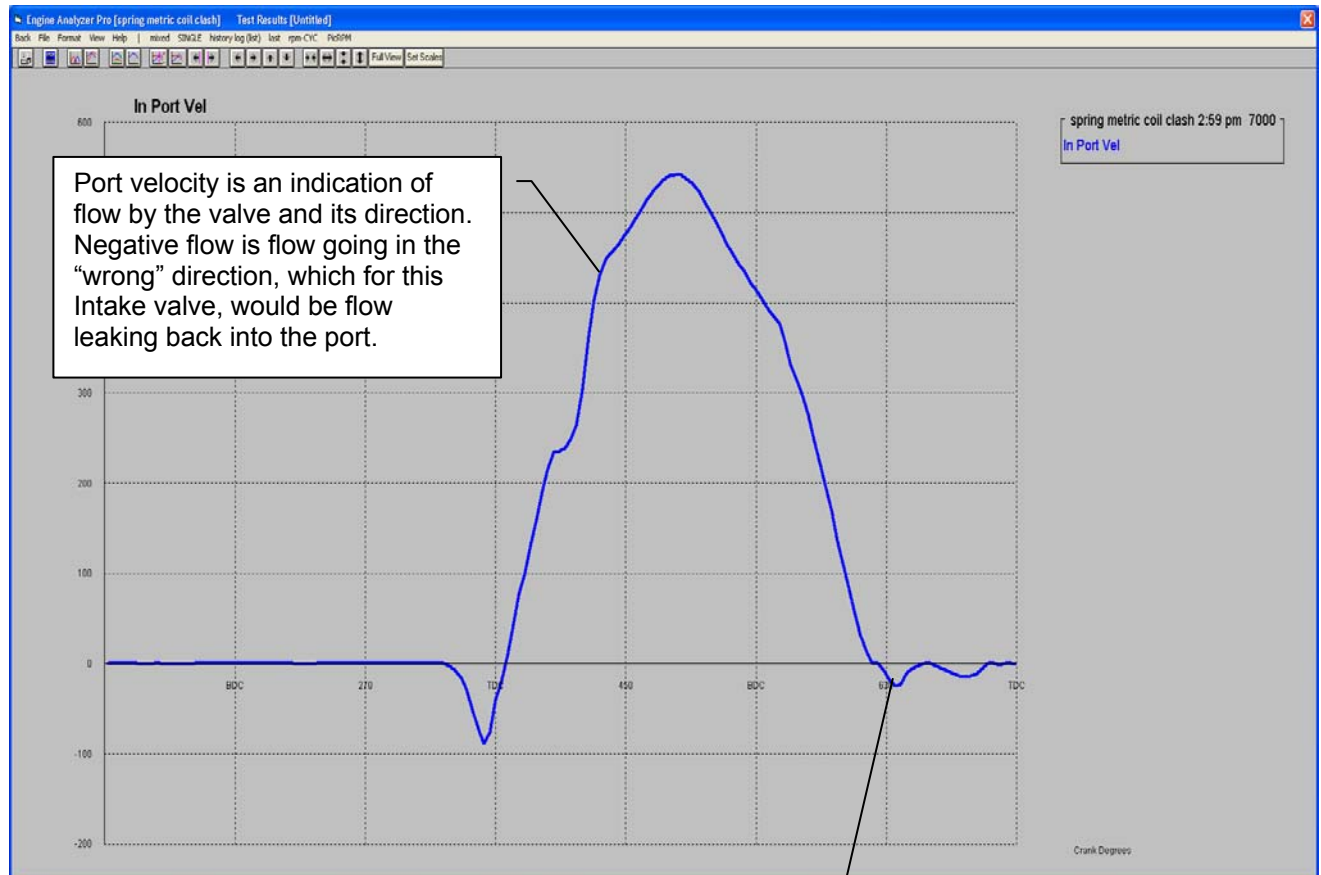

Figure A93 Checking Effect of Valve Bounce on Performance



Port velocity is an indication of flow by the valve and its direction. Negative flow is flow going in the “wrong” direction, which for this Intake valve, would be flow leaking back into the port.

These negative flows shown here are from the valve bouncing on the seat, and flow leaking back into the intake port from the cylinder. This “leaking” would result in a loss of performance.

With the standard version Engine Analyzer Pro, the program assumes all flow stops (the valve seats and stays seated) at the valve seat closing event, even if valve train dynamics show the valve could be bouncing.

Only the Enterprise Edition lets the valve flow continue past the seat closing event.

Index

- 1st Stage HP Rating, 68
- 1st Stage Starting RPM, 69
- 2nd Stage Added HP, 69
- 2nd Stage Starting RPM, 69
- 32 bit, 235
- 3rd Stage Added HP, 69
- 3rd Stage Starting RPM, 69
- 4 Valve, 49, 253
- A/F Mxtr Qlty, 76, 77, 206
- A/R Ratio, 122
- Accel Rate, 16, 65
- Accelerating, 16, 65, 99, 100, 236
- Accuracy, 6, 1, 3, 17, 18, 21, 22, 29, 38, 45, 49, 83, 84, 85, 93, 95, 97, 98, 100, 107, 109, 111, 115, 148, 158, 169, 172, 192, 193, 201, 202, 203, 221, 230, 231, 235, 236, 251, 253, 263, 277, 278
- Acrobat, 235, 251, 261, 277
- Act EVLift, 142
- Act Ex FlowArea, 83, 84
- Act In FlowArea, 83, 84
- Act IVLift, 142
- Actual CFM, 76, 180, 181, 183, 219, 220, 221
- Actual Valve Lash, 42
- Adobe, 251, 261
- Air Bleed, 34, 164, 165, 166
- Air Cleaner Shape, 111
- Air Meter, 115, 235, 252
- Angles, Valve, 237, 252
- Anti-Reversion, 22, 24, 103, 188, 189, 191
- Area, 19, 31, 82, 87, 94, 108, 114, 117, 122, 123, 142, 165, 174, 192, 202, 262
- Area Change, 117, 165
- ASCII Files, 5, 1, 74, 125, 130, 232, 261, 277
- Assumptions, 3, 15, 17, 25, 28, 31, 32, 33, 38, 41, 42, 44, 53, 57, 61, 66, 67, 77, 84, 85, 89, 91, 92, 93, 95, 112, 117, 166, 183, 192, 201, 203, 206, 220, 252, 278
- Asymmetry (cam profile), 261, 262
- Auto-Link, 236, 251
- AutoScaling, 236
- Avg Ex Vel, 82
- Avg In Vel, 82
- Avg Port Diameter, 17, 24, 97, 100, 188, 194
- Backup, 251, 259
- Barometric Pressure, 63, 64, 75, 93, 123, 222
- Baseline, 148, 159, 162, 167, 180, 182, 183, 185, 192, 196, 249
- Bearing Size, 14, 98, 220, 236, 263
- Belt Ratio, 15, 52, 53, 56, 120, 182, 219, 220
- Bench Test Pres, 111
- Blow By, 82
- Blow-by, 15, 82, 263
- BMEP, 77, 79
- Booster Signal, 115
- Bore, 13, 14, 73, 93, 98, 99, 104, 105, 212, 221, 235
- Brake HP, 6, 75, 130, 132, 164, 174, 177, 194, 196, 211, 212, 221
- Break Point #1, 70, 71
- Break Point #1, Spark Advance, 70, 71
- Break Point #2, 71
- Break Point #2, Spark Advance, 71
- Brk Tq, 6, 75, 130, 164, 174, 177, 186, 194, 196, 221
- Browse, 261, 277
- BSFC, 14, 78
- Burn Rating (previously Swirl Rating), 23, 236
- Calc Error, 85
- Calculation Type, 113, 114
- Cam, 2, 5, 6, 1, 7, 9, 14, 22, 41, 42, 43, 44, 45, 46, 47, 48, 67, 72, 82, 83, 84, 87, 88, 89, 90, 91, 92, 93, 95, 96, 98, 103, 106, 117, 118, 119, 120, 142, 148, 158, 167, 168, 169, 170, 171, 172, 173, 174, 175, 177, 178, 192, 193, 194, 201, 202, 203, 204, 210, 211, 213, 220, 221, 223, 230, 232, 233, 235, 236, 237, 249, 252, 253, 261, 262, 263, 277, 278, 287
- Cam Advance, 44, 46, 220
- Cam Analyzer, 41, 43, 168, 169, 172, 233, 252, 261
- Cam Bearing Diameter, 98
- Cam Bearing Width, 98
- Cam File, 41, 43, 44, 45, 170, 252, 263, 278
- Carb Signal, 143
- Carb/T-B CFM Rating, 30, 31, 111, 114, 143, 166, 204, 236, 252, 253
- Centerline, 41, 42, 45, 46, 72, 168, 220, 233, 234
- CFM, 18, 21, 28, 29, 30, 36, 37, 38, 55, 57, 58, 59, 76, 82, 86, 103, 104, 106, 109, 110, 111, 114, 115, 116, 120, 121, 122, 157, 160, 161, 163, 164, 165, 166, 177, 180, 181, 187, 188, 190, 191, 219, 220, 221, 222, 252, 277
- CFM @ Peak Eff, 122
- CFM Rating, 28, 29, 36, 37, 38, 114, 115, 116, 219, 220, 221, 222, 252
- CFM Rating CFM *, 114
- Chain, 5, 72, 199, 200, 261, 263, 277
- Chain Calc These Cams, 261
- Chain Closing Cam Events, 277
- Chain Step Size, 72, 73
- Chamber CCs in Head, 104
- Chamber Design, 22, 23, 278
- Chassis Dyno, 235
- Clash, Valve, 253
- Clearance Volume, 22, 92, 93, 104
- Closing Events, 90
- Cmprsr Pres Ratio, 86

CNG, 213, 235
 Collector Dia, 39, 116
 Collector Length, 39
 Collector Taper, 39
 Combustion Chamber, 213
 Common List, 132, 136, 137, 147, 148, 151, 171, 172, 173, 178, 248, 250
 Comp Cams, 262, 278
 Company Logo, 261
 Component Wts, 99
 Compression Ratio, 6, 7, 13, 22, 92, 93, 97, 104, 213, 235, 287
 Compressor Eff, 86, 180, 181
 Compressor HP, 78, 79, 86, 182
 Compressor Map, 56, 58, 59, 121, 180, 252, 277, 278, 287
 Compressor RPM, 86
 Controlled Valve Toss, 236
 Coolant HP, 81, 235
 Coolant Temp, 65, 213, 222
 Cooling Fan Type, 15, 206, 220, 222
 Crank Pulley Diameter, 52, 56, 120
 Cranking Compression, 92, 174, 263
 Cranking RPM, 263
 Crower, 2, 261, 262
 Current Length, 94
 Cycle Data, 72, 82, 142
 Cyl Leakage, 82
 Cyl Pres, 142, 183
 Cyl Temp, 142
 Cyl Vol, 92, 143

Decimal Places, 263, 278
 Deck Height, 104, 105
 Deck Height Clearance, 104, 105
 Delete, 277
 Depth, 113
 Depth in Center, 113
 Design, 16, 35, 47, 65, 110, 213, 252
 Designed Valve Lash, 42, 44
 Desktop Dyno (tm), 262
 Dew Point, 64, 123, 222
 Diameter, 11, 21, 33, 35, 39, 52, 97, 98, 100, 106, 108, 112, 160, 164, 188, 189, 193
 Diesel, 235
 Direct Injection, 22, 278
 Displacement, 6, 92, 113, 114, 263
 Dot Matrix, 146, 236
 Dry Bulb Temp, 124
 Dual Plane, 27, 160, 161, 189, 216
 Duration, 41, 42, 45, 46, 90, 91, 168, 233, 234, 235
 Duration @ .050, 168, 233, 234
 Dwell Over Nose, 235
 Dynamic Comp. Ratio, 92
 DynoSim (tm), 262

E85, 262
 Eff Lifter Mass, 48, 49, 119
 Eff Lifter Stiffness, 48, 49

Eff Rckr Arm Stffnss, 47, 49, 117
 Eff Valve Mass, 47, 49, 117
 Element Type, 112
 Elevation, 63, 64, 75, 123, 222
 Email, 1, 2, 251, 261, 277
 EMC (Engine Masters Challenge), 263
 Engine File, 5, 147, 148, 149, 152, 153, 172, 235, 250, 251, 277, 278
 Engine HP, 21, 116
 Engine Library, 1, 5, 147, 158, 164, 167, 179, 252
 Engine Masters Challenge, 263
 Engine RPM, 6, 75
 Enterprise Edition, 6, 1, 47, 55, 58, 143, 277, 278, 287
 Estimated Idle Vacuum, 263
 Ethanol, 262
 Ex Cam Accl, 142
 Ex Cam Vel, 142
 Ex Flow Ar, 142
 Ex Port Vel, 142
 Ex Pshrd F, 142
 Ex Vlv Lift, 142
 Example Component Files, 147, 261, 262
 Excel, 5, 1, 74, 125, 130, 232, 261, 277
 Exh Pres, 38, 75, 181, 182, 219, 221
 Exh Temp, 80
 Exh Turbine Eff, 60
 Exhaust System, 5, 35, 100, 105, 106, 107, 108, 116, 213, 219, 221
 ExPort Pres, 229

Factor button, 236
 File, Engine, 2, 5, 43, 74, 84, 91, 97, 130, 132, 136, 145, 148, 155, 157, 168, 169, 170, 172, 173, 175, 178, 179, 182, 188, 193, 194, 200, 219, 232, 235, 237, 249, 250, 251, 252, 261, 262, 277, 278, 287
 Filter (smooth) Cam Lobe File, 263
 Firing Method, 32
 Floppy, 232, 235
 Flow at Peak Eff, 121
 Flow Bench Flow, 111
 Flow Coef, 14, 18, 19, 20, 21, 23, 26, 27, 34, 36, 83, 87, 88, 89, 102, 105, 106, 107, 142, 161, 174, 187, 188, 189, 190, 191, 192, 217, 220, 221, 235
 Flow Obtained, 103
 flow table, 18, 19, 21, 22, 24, 187, 188, 190, 191, 192, 220, 235, 236, 252, 261
 Flow Table, 18, 19, 21, 22, 24, 187, 188, 190, 191, 192, 220, 235, 236, 252, 261
 Flow w/o Runner, 106, 107
 Flow with, 106
 Flow-Normal Direction, 103
 Flow-Reverse Direction, 103
 Flywheel Diameter, 99
 Flywheel Weight, 99
 FMEP, 77, 79
 Font, 236
 Force on R.A. Tip, 118
 Fraction Eng Disp, 114

- Frctn HP, 78, 79
 Frctn Tq, 78
 Fuel Economy, 251
 Fuel Flow, 76, 77, 78, 132, 181, 183, 208, 209, 219, 220
 Fuel Octane (R+M)/2, 66, 67
 Fuel Type, 66
 Full HP Rating of System, 68
- Gasket Bore Dia, 105
 Gasket Thickness, 97, 104
 Graph dyno power curves, 261
 Graph on the Cam Specs, 277
 Graph Set Scales, 236
 Graphics File, 277
 Graphs, 5, 1, 6, 68, 69, 127, 128, 130, 131, 132, 133, 134, 136, 137, 138, 139, 140, 141, 142, 148, 158, 159, 160, 161, 162, 163, 164, 165, 167, 169, 170, 171, 172, 173, 174, 175, 176, 177, 181, 182, 186, 189, 191, 192, 193, 194, 199, 200, 229, 236, 248, 249, 250, 251, 253, 261, 277, 278
 Gross Valve Lift, 46, 168, 169, 261, 262
 Grss Tappet Lft, 91
- Harley Davidson, 262
 Headers, 35, 36, 38
 Heat Release, 236, 253
 Heat Trnsfr, 143
 Height, 94, 100, 101, 104, 108, 112
 History, 235, 248, 249, 250, 252
 Hole Dia, 110
 Housing Radius, 123
 HP, 6, 11, 20, 38, 44, 45, 63, 67, 68, 69, 72, 74, 75, 76, 77, 78, 79, 81, 82, 86, 87, 93, 95, 96, 115, 116, 129, 143, 157, 158, 159, 161, 163, 167, 171, 172, 173, 174, 175, 177, 179, 180, 181, 182, 183, 187, 190, 192, 193, 196, 197, 198, 199, 200, 201, 203, 208, 209, 210, 211, 212, 219, 220, 221, 222, 223, 230, 235, 236, 237, 249, 253, 261, 263
- Idle Vacuum, 87, 93, 174, 263
 IMEP, 77, 78, 79
 Imports, 262
 In Cam Accl, 142
 In Cam Vel, 142
 In Flow Ar, 142
 In Port Tmp, 161, 181, 183
 In Port Vel, 142, 194, 196
 In Pshrd F, 142
 In Tun Pres, 161
 In Vlv Lift, 142, 177
 Include Averages, 263
 Inertia, 2, 16, 54, 65, 82, 94, 95, 99, 100, 143, 214, 215, 216, 236
 Injector Rated Pres, 32
 Injector Rating, 31, 32
 InPort Pres, 142, 194, 196
 Inside Dia at Exit, 35, 116
 Inside Dia at Head, 35, 116
- Installation, 5, 4
 Instnns Tq, 143
 Intake Air Temp, 63, 64, 75, 222
 Intake Duration, 7, 42, 45, 83, 88, 90, 91, 92, 95, 96, 169, 172, 177, 220, 221, 233, 235
 Intake Heat, 28, 161, 189, 219, 221
 Intake Manifold, 6, 18, 157, 191
 Intercooler, 54, 57, 61, 235, 251, 252
 Intercooler Eff, 54, 57, 61, 251
 Internal Gear Ratio, 56
 Isky, 2, 262
 Island CFM, 55, 57, 58, 59, 60, 120, 122, 220
 Island Efficiency, 56
 Island Pressure Ratio, 56, 59
 Island RPM, 56
- KG, 278
 Knock Index, 67, 69, 70, 71, 84, 180, 181, 182, 184, 185, 186, 235, 263, 278
 Know, 97, 100, 108, 114, 115, 123, 124, 160, 189
- Landscape, printer, 249, 261
 Lash, 42, 44, 45, 168, 170, 173, 278
 Lb x Ft², 16, 99
 Leakage (seals), 52
 Length, 14, 30, 94, 97, 113, 193, 222
 Lifter, 6, 11, 28, 42, 44, 46, 48, 49, 83, 84, 90, 91, 95, 96, 118, 119, 142, 161, 167, 169, 170, 173, 174, 177, 220, 233, 236, 251, 253, 287
 Lifter (profile) Type, 42, 44, 169
 Lobe Area, 90, 174
 Lobe Centerlns, 91
 Lobe Separation, 46, 89, 261
 Logo, Company, 261
 LSx, 262
 LTx, 262
 Lunati, 2, 262
- Mach #, 82, 83, 219, 221
 Main Bearing Diameter, 98
 Main Bearing Width, 98
 Main Venturi Dia, 115
 Main Venturi Flow, 115
 Manifold Type, 27, 29, 30, 85, 160, 189, 216, 251
 Map Barometer, 121
 Map Temperature, 121
 Material/Coating, 14, 23
 Max Boost Limit, 53, 57, 61, 179
 Max Lobe Lift, 42, 45, 46, 91, 169
 Max Safe Impeller RPM, 57
 Max Valve Lift, 278
 Maximum Flow, Turbo, 252
 Mech Eff, 79, 86, 211, 212
 Mech Friction, 52
 Metric, 63, 64, 74, 252, 263
 Millimeters, 235
 Motoring HP, 78, 79, 86, 219, 220, 221
 Mufflers, 38, 116

Mx Cyl Pres, 70, 71, 80
 Mx Cyl Tmp, 80

 Nitrous, 6, 67, 68, 77, 179, 183, 213
 Nitrous Oxide, 5, 63, 67, 68, 69, 76, 77, 81, 88, 96, 179, 183, 184, 210, 213, 236
 Nozzle Area, 123, 253
 Nozzle Diameter, Turbo Turbine, 60, 123, 262
 Ntrs Fuel, 68, 76, 77, 78, 183
 Number of RPM Steps, 65, 66
 Number of S/Cs, 53, 57, 59

 Octane, 1, 66, 67, 76, 77, 180, 184, 185, 206
 OHC, 20, 48, 253, 263
 Opening Events, 90
 Operating Fuel Pres, 32
 Other Format Files, 262
 Outside Air Temp, 123
 Outside Rel Humidity, 124
 Overlap, 87, 88, 90, 127, 174, 234
 Overlap Area, 87, 88, 174

 PDF, Adobe, 235, 251, 261, 277
 Peak Thermal Eff., 53
 Picture File, 277
 Piston, 1, 7, 13, 14, 15, 22, 23, 74, 77, 78, 79, 81, 92, 93, 104, 105, 125, 142, 143, 153, 174, 178, 194, 197, 208, 211, 212, 214, 217, 237, 251, 253
 Piston Dome, 97, 104
 Piston Dome CCs, 97, 104
 Piston Gs @ TDC, 81
 Piston Rings, 13
 Piston Skirt, 14, 220
 Piston Spd, 81
 Piston Speed, 79, 81, 263
 Piston Top, 14, 23
 Piston-To-Valve, 237
 Pk Secondary Tuning RPM, 93
 Plenum Volume, 30, 112
 Port Length, 18, 24, 94, 97, 101, 188, 193
 Port/Runner Volume, 101
 Portrait, printer, 261
 Power Valve, 33
 Preferences, 5, 11, 63, 64, 74, 84, 92, 93, 164, 235, 236, 237, 248, 250, 251, 252, 253, 261, 263, 277, 278, 287
 Pressure Control, 32
 Primary Jet, 31, 34, 84, 85, 164, 165, 166, 181, 182
 Primary Pipe Dia, 116
 Primary Throttle Dia, 109, 114
 Primary Tube O.D., 95
 Primary Venturi Diameter, 33, 164, 166
 Pstn Gs, 143
 Pstn Pos, 143
 Pstn Thrst, 143
 Pstn Vel, 142
 PstnSpd, 79, 81, 142
 Pumpng Work, 79, 196
 Pushrod, 47, 48, 119, 175, 177, 205

 Ramp Rating, 252
 Rec Area, 94, 95
 Rec Len, 95
 Recycle Bin, 277
 Residual Exh, 80
 Restore, 236, 251, 252, 259
 Restrictor, 110, 235, 252
 Retainer + Locks, 117
 Retrieve, 5, 155, 157, 164, 167, 172, 179, 182, 188, 193, 252
 Rocker Arm Ratio, 42, 43, 46, 47, 48, 49, 117, 118, 119, 169, 234, 236, 252, 262, 287
 Rocker Arm wo Fulcrum, 117
 Rod Bearing Diameter, 98
 Rod Bearing Width, 98
 Rod Length, 13
 Roller Bearings, 236
 Roots Vol Eff, 86
 Rotating Mass Diameter, 99
 Rotating Mass Weight, 99
 Rows or Columns, ASCII Files, 277
 RPM, 1, 6, 7, 11, 16, 23, 27, 29, 38, 45, 47, 51, 52, 53, 55, 56, 57, 58, 65, 66, 67, 68, 69, 70, 71, 72, 74, 75, 78, 79, 81, 82, 83, 84, 85, 86, 87, 88, 92, 93, 94, 95, 129, 130, 132, 133, 136, 142, 158, 161, 163, 164, 166, 171, 172, 173, 174, 175, 177, 180, 181, 182, 183, 185, 186, 193, 194, 196, 197, 198, 200, 210, 212, 215, 216, 219, 220, 221, 223, 225, 226, 227, 236, 237, 261, 262, 263, 278
 RPM Step Size, 65, 66
 RPM to Start Nitrous Injection, 68
 Runner, 18, 22, 25, 26, 27, 28, 30, 33, 35, 36, 39, 67, 81, 82, 87, 88, 93, 94, 95, 97, 100, 101, 102, 105, 106, 107, 108, 109, 132, 142, 160, 161, 187, 189, 190, 191, 193, 194, 195, 196, 198, 201, 203, 205, 214, 215, 216, 217, 219, 220, 221, 231, 236, 252, 253, 287
 Runner Dia @ Head, 25, 160, 189
 Runner Diameter, 26, 100, 101, 106, 194, 195, 252
 Runner Flow Coef, 22, 25, 26, 27, 35, 36, 105, 106, 107, 187, 189, 190, 191, 198, 217, 219, 220, 221, 287
 Runner Length, 18, 25, 94, 161, 189, 193, 194, 195, 196
 Runner Taper, 25, 28, 100

 S/C Pulley Diameter, 52, 56, 120
 Save, 5, 130, 148, 167, 172, 179, 188, 194, 200, 236, 249
 Seated Spring Force, 49, 119
 Seated Spring Height, 120
 Secondary Throttle Dia, 29, 109, 115, 220
 Secondary Throttles, 29, 220
 See Engine, 5, 1, 6, 153, 154, 223, 237, 251, 253
 Send, 1, 2, 251, 261, 277
 Setup, 138, 251, 261
 Shape, 102, 112, 113, 161, 189
 Show Examples Only Fitting These Limits, 261
 Shrt Circuit, 76, 80
 Single Flow Coef, 18, 19, 20, 21, 24, 26, 27, 102, 187, 188, 189, 191, 192
 Single Plane, 27, 160, 161, 162

- Spark, 1, 22, 23, 55, 63, 66, 67, 69, 70, 71, 80, 84, 180, 183, 184, 185, 186, 203, 206, 208, 211, 213, 220, 235, 236, 262
- Spark Advnc, 84
- Spark Curve, 1, 69, 70, 185, 186, 262
- Spec to Use, 122, 123
- Spec Type and Name, 72, 73
- Special Calculations, 7, 74, 87, 192, 194, 237, 252, 253, 263, 278
- Spring + Damper, 117
- Spring Force, 119, 120, 263
- Spring Height, 120, 263
- Spring Rate, 48, 49, 119
- Starting RPM, 65, 66
- Starting Spec Value, 73
- Stroke, 13, 79, 81, 82, 93, 99, 104, 210, 212, 221, 235
- Surge CFM, 59
- Swirl Rating, 23
- Test Pressure, 21, 22, 102, 103, 105, 106, 111, 115, 187, 188, 190, 191, 192
- Theo. Crank Comprsn, 92
- Thermal Eff, 53, 78, 211, 212
- Throttle Location, 53, 57, 61, 252
- Torque, 6, 28, 44, 45, 65, 67, 72, 74, 75, 78, 82, 93, 99, 100, 132, 143, 157, 158, 159, 161, 163, 171, 172, 173, 174, 175, 177, 180, 182, 183, 186, 199, 200, 201, 203, 211, 214, 215, 216, 217, 219, 221, 222, 235, 236, 237, 249, 253, 261, 263
- Total # Injectors on Engine, 32
- Total # Pri. Throttle Plates, 109, 114
- Total # Sec. Throttle Plates, 109, 115
- Total Avg Flow Coef, 88, 89
- Total Cam Advance, 44
- Total CFM Rating, 28, 29, 37, 114, 158, 160, 189, 220, 221
- Total Exh/Int %, 88, 174
- Total Length, 35, 36
- Tq / HP Data on graph printout, 261
- Tuning Pressures, 5, 125, 126, 127, 223, 224, 229, 236
- Turbine Nozzle Dia, 60, 121
- Turbo Map, 277, 287
- Turbo Surge, 86
- Turbo Turbine, 58, 60, 61, 86, 121, 122, 123, 179, 219, 236, 252, 262, 287
- Turbo Turbine Nozzle Diameter, 60, 123, 262
- Turbo Wastegt, 61, 86, 179, 181, 236, 252
- Type of Vehicle, 116
- Valve Clash, 253
- Valve Dia, 17, 21, 22, 24, 103, 105, 106, 188, 191, 221
- Valve Diameter, 17, 21, 22, 24, 103, 105, 106, 188, 191, 221
- Valve Lift, 1, 7, 18, 19, 21, 22, 41, 42, 43, 44, 45, 46, 83, 88, 89, 90, 91, 95, 96, 102, 103, 104, 106, 120, 142, 167, 168, 169, 171, 172, 175, 177, 178, 187, 188, 190, 191, 192, 197, 220, 221, 233, 234, 235, 236, 251, 252, 261, 262, 277, 278, 287
- Valve Lift Tested, 103, 106
- Valve Spring Dynamics, 277, 278, 287
- Valve spring motion, 278
- Valve Toss, 83, 175, 177, 178, 236, 287
- Valve Train Type, 47, 48, 49
- Valve Weight, 117
- Variable Valve Timing (VVT), 262, 278, 285
- Venturi Discharge Coef, 34, 115, 166
- Version 3.9B, 1, 6, 1, 277
- Vista, 2, 262
- Vlv Area, 87, 88
- Vol Eff, 75, 76, 80, 194, 196, 210, 212
- Volume, 22, 52, 53, 86, 97, 104, 112, 189, 262
- Volume/Revolution, 52, 53
- Volumetric Efficiency, 14, 75, 76, 80, 81, 82, 83, 85, 86, 88, 93, 158, 201, 210, 213, 214, 215, 223, 252
- Wastegate Is..., 252
- Weather, 54, 57, 61, 213
- Wet Bulb Temp, 124
- Width, 94, 98, 100, 101, 108, 112, 113, 236
- Windows, 1, 2, 43, 138, 157, 201, 203, 217, 219, 232, 235, 251, 261